

## Automotive power Schottky rectifier

Datasheet – production data

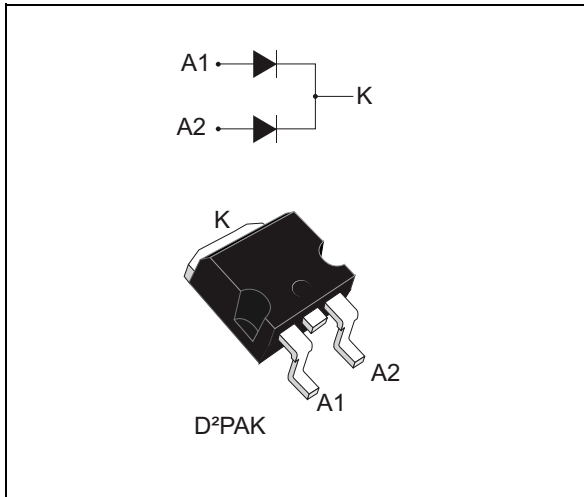

### Description

Dual center tap Schottky rectifier designed for high frequency miniature switched mode power supplies such as adaptators and on board DC/DC converters for automotive applications.

Table 1. Device summary

Symbol	Value
$I_{F(AV)}$	2 x 10 A
$V_{RRM}$	100 V
$T_{j(max)}$	175 °C
$V_F (Typ)$	0.59 V

### Features

- Negligible switching losses
- High junction temperature capability
- Good trade off between leakage current and forward voltage drop
- Low leakage current
- Avalanche rated
- AEC-Q101 qualified.
- PPAP capable

# 1 Characteristics

**Table 2. Absolute ratings (limiting values per diode at 25 °C, unless otherwise specified)**

Symbol	Parameter		Value	Unit
$V_{RRM}$	Repetitive peak reverse voltage		100	V
$I_{F(RMS)}$	Forward rms current		30	A
$I_{F(AV)}$	Average forward current, $\delta = 0.5$ , $T_c = 160\text{ °C}$	per diode	10	A
		per device	20	
$I_{FSM}$	Surge non repetitive forward current	$t_p = 10\text{ ms}$ sinusoidal	250	A
$I_{RSM}$	Non repetitive peak reverse current	$t_p = 100\text{ }\mu\text{s}$ square	3	A
$P_{ARM}^{(1)}$	Repetitive peak avalanche power	$t_p = 10\text{ }\mu\text{s}$ , $T_j = 125\text{ °C}$	780	W
$T_{stg}$	Storage temperature range		-65 to +175	°C
$T_j$	Operating junction temperature <sup>(2)</sup>		-40 to +175	°C

1. For pulse time duration deratings, please refer to [Figure 3](#). More details regarding the avalanche energy measurements and diode validation in the avalanche are provided in the STMicroelectronics Application notes AN1768, “Admissible avalanche power of Schottky diodes” and AN2025, “Converter improvement using Schottky rectifier avalanche specification”.

2.  $\frac{dP_{tot}}{dT_j} < \frac{1}{R_{th(j-a)}}$  condition to avoid thermal runaway for a diode on its own heatsink

**Table 3. Thermal parameters**

Symbol	Parameter		Value	Unit
$R_{th(j-c)}$	Junction to case	per diode	1.6	°C/W
		per device	0.9	
$R_{th(c)}$	coupling		0.15	

When the diodes 1 and 2 are used simultaneously:

$$\Delta T_j(\text{diode } 1) = P(\text{diode } 1) \times R_{th(j-c)}(\text{Per diode}) + P(\text{diode } 2) \times R_{th(c)}$$

**Table 4. Static electrical characteristics (per diode)**

Symbol	Parameter	Test conditions		Min.	Typ	Max.	Unit
$I_R^{(1)}$	Reverse leakage current	$T_j = 25\text{ °C}$	$V_R = V_{RRM}$	-	-	4.5	$\mu\text{A}$
		$T_j = 125\text{ °C}$		-	2	6	mA
$V_F^{(2)}$	Forward voltage drop	$T_j = 25\text{ °C}$	$I_F = 10\text{ A}$	-	-	0.77	V
		$T_j = 125\text{ °C}$		-	0.59	0.64	
		$T_j = 25\text{ °C}$	$I_F = 20\text{ A}$	-	-	0.88	
		$T_j = 125\text{ °C}$		-	0.67	0.73	

1. Pulse test:  $t_p = 5\text{ ms}$ ,  $\delta < 2\%$

2. Pulse test:  $t_p = 380\text{ }\mu\text{s}$ ,  $\delta < 2\%$

To evaluate the conduction losses use the following equation:  
 $P = 0.55 \times I_{F(AV)} + 0.009 \times I_{F(RMS)}^2$

**Figure 1. Average forward power dissipation versus average forward current (per diode)**

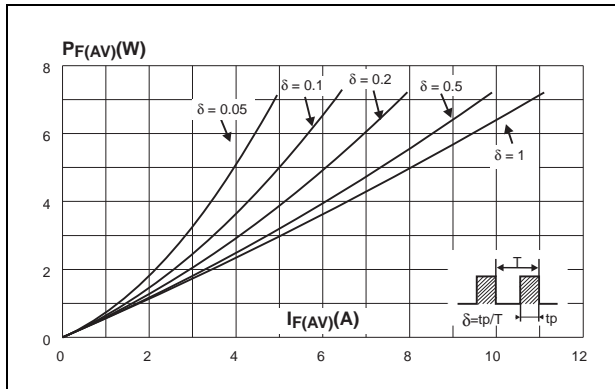

**Figure 2. Average forward current versus ambient temperature ( $\delta = 0.5$ , per diode)**

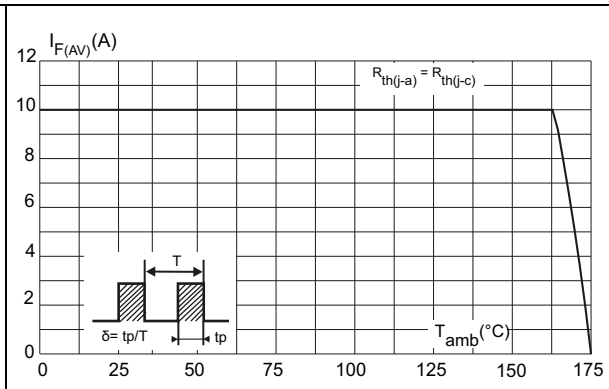

**Figure 3. Normalized avalanche power derating versus pulse duration**

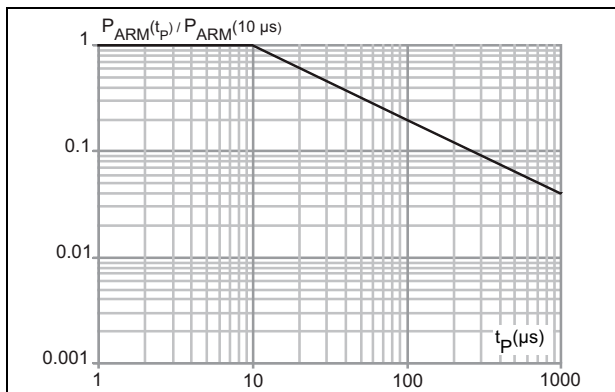

**Figure 4. Relative variation of thermal impedance junction to case versus pulse duration (per diode)**

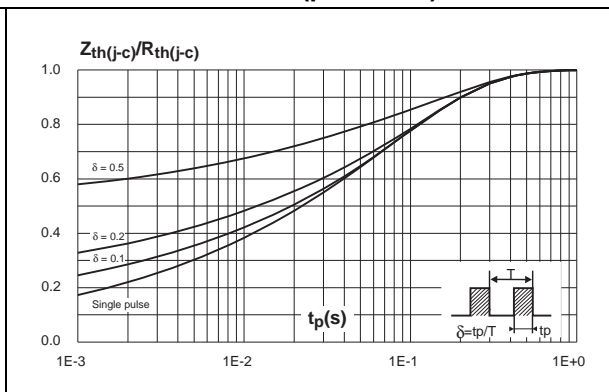

**Figure 5. Reverse leakage current versus reverse voltage applied (typical values, per diode)**

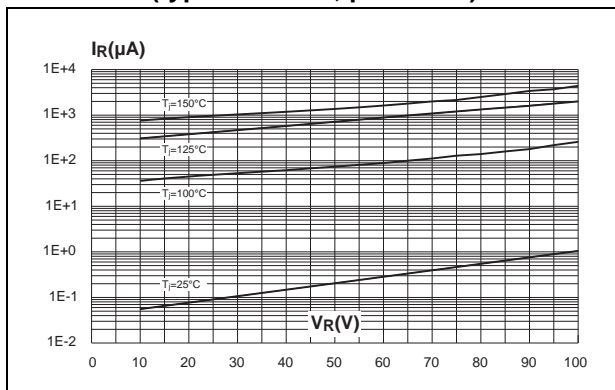

**Figure 6. Junction capacitance vs. reverse voltage applied (typical values, per diode)**

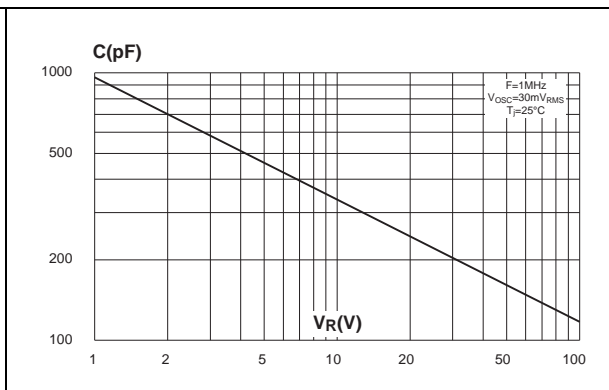

Figure 7. Forward voltage drop vs. forward current (typical values, per diode)

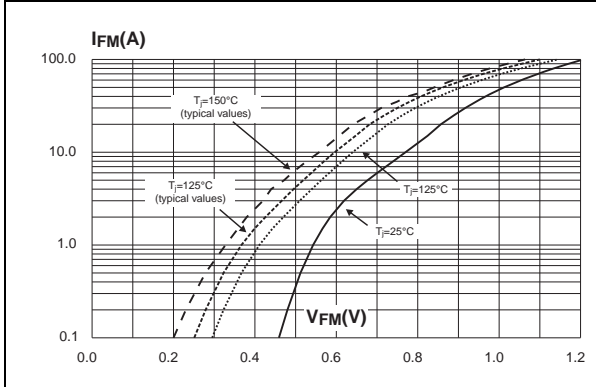
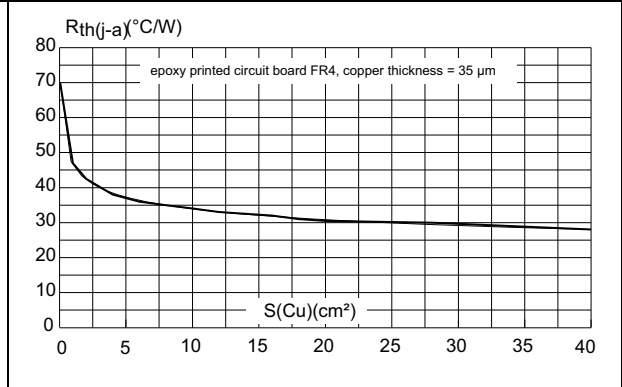

Figure 8. Thermal resistance junction to ambient versus copper surface under tab



## 2 Package information

- Epoxy meets UL94, V0
- Lead-free package
- Cooling method: by conduction (C)

In order to meet environmental requirements, ST offers these devices in different grades of ECOPACK® packages, depending on their level of environmental compliance. ECOPACK® specifications, grade definitions and product status are available at: [www.st.com](http://www.st.com). ECOPACK® is an ST trademark.

Figure 9. D<sup>2</sup>PAK dimension definitions

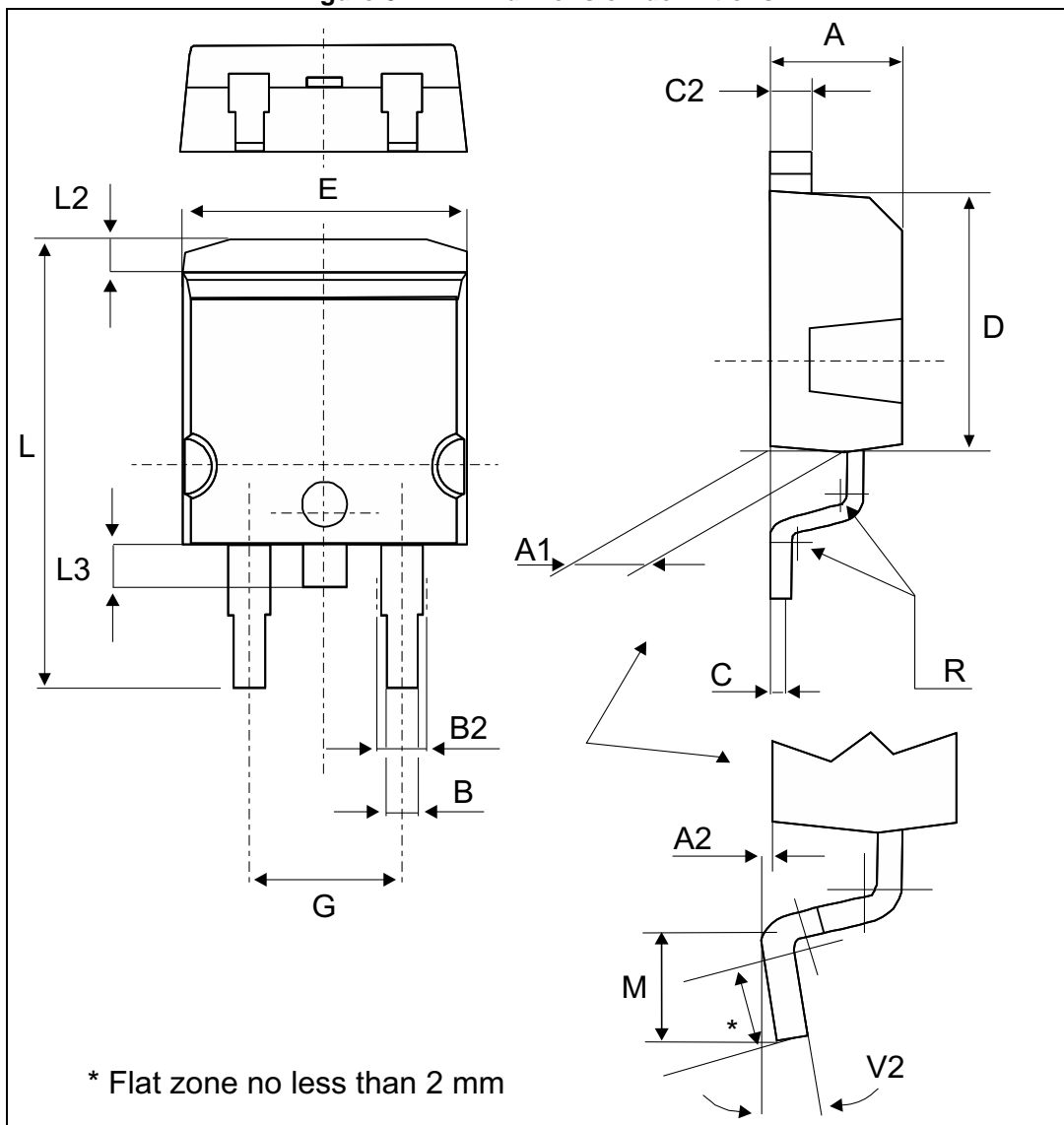
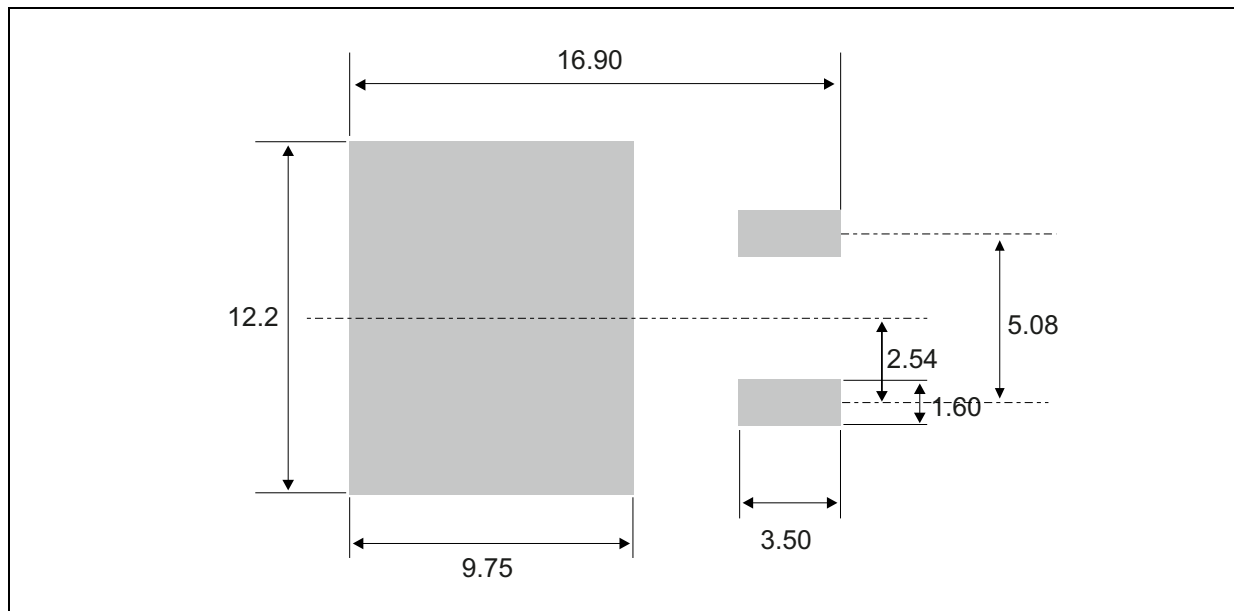

Table 5. D<sup>2</sup>PAK dimension values

Ref.	Dimensions					
	Millimeters			Inches		
	Min.	Typ.	Max.	Min.	Typ.	Max.
A	4.40		4.60	0.173		0.181
A1	2.49		2.69	0.098		0.106
A2	0.03		0.23	0.001		0.009
B	0.70		0.93	0.027		0.037
B2	1.14		1.70	0.045		0.067
C	0.45		0.60	0.017		0.024
C2	1.23		1.36	0.048		0.054
D	8.95		9.35	0.352		0.368
E	10.00		10.40	0.393		0.409
G	4.88		5.28	0.192		0.208
L	15.00		15.85	0.590		0.624
L2	1.27		1.40	0.050		0.055
L3	1.30		1.75	0.051		0.069
M	2.29		2.79	0.090		0.110
R		0.40 typ.		0.016 typ.		
V2	0°		8°	0°		8°

Figure 10. Footprint (dimensions in mm)



### 3 Ordering information

**Table 6. Ordering information**

Order code	Marking	Package	Weight	Base qty	Delivery mode
STPS20H100CGY-TR	STPS20H100CGY	D <sup>2</sup> PAK	1.48 g	1000	Tape and reel

### 4 Revision history

**Table 7. Revision history**

Date	Revision	Changes
19-Nov-2014	1	First issue

**IMPORTANT NOTICE – PLEASE READ CAREFULLY**

STMicroelectronics NV and its subsidiaries ("ST") reserve the right to make changes, corrections, enhancements, modifications, and improvements to ST products and/or to this document at any time without notice. Purchasers should obtain the latest relevant information on ST products before placing orders. ST products are sold pursuant to ST's terms and conditions of sale in place at the time of order acknowledgement.

Purchasers are solely responsible for the choice, selection, and use of ST products and ST assumes no liability for application assistance or the design of Purchasers' products.

No license, express or implied, to any intellectual property right is granted by ST herein.

Resale of ST products with provisions different from the information set forth herein shall void any warranty granted by ST for such product.

ST and the ST logo are trademarks of ST. All other product or service names are the property of their respective owners.

Information in this document supersedes and replaces information previously supplied in any prior versions of this document.

© 2014 STMicroelectronics – All rights reserved