

Features

- Ideal for indication light on hand held products
- Long life and robust package
- Standard Package: 2000pcs/ Reel
- MSL (Moisture Sensitivity Level): 3
- RoHS compliant.



ATTENTION
OBSERVE PRECAUTIONS
FOR HANDLING
ELECTROSTATIC
DISCHARGE
SENSITIVE
DEVICES

Package Schematics

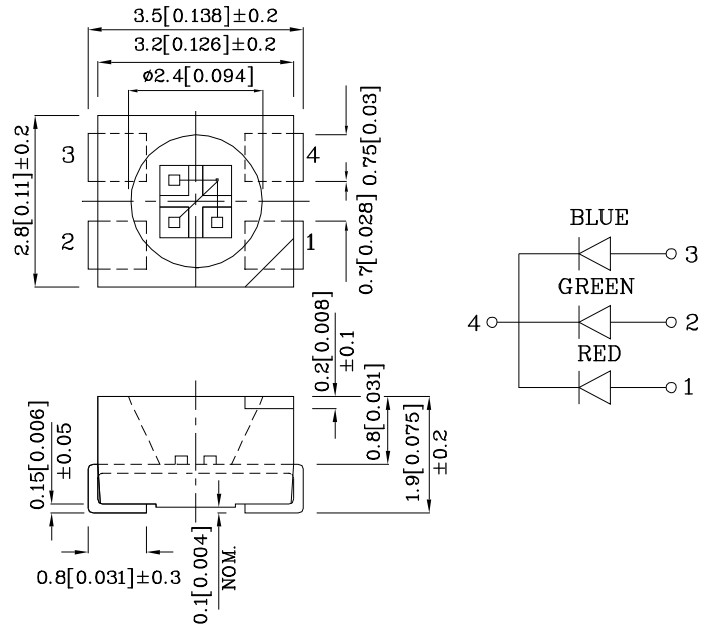

Notes:

1. All dimensions are in millimeters (inches).
2. Tolerance is $\pm 0.25(0.01)$ unless otherwise noted.
3. Specifications are subject to change without notice.

Absolute Maximum Ratings ($T_A=25^\circ\text{C}$)		Red (AlGaInP)	Green (InGaN)	Blue (InGaN)	Unit
Reverse Voltage	V_R	5	5	5	V
Forward Current	I_F	50	30	30	mA
Forward Current (Peak) 1/10 Duty Cycle 0.1ms Pulse Width	i_{FS}	150	100	100	mA
Power Dissipation	P_D	140	120	120	mW
Electrostatic Discharge Threshold (HBM)		3000	450	250	V
Operating Temperature	T_A	-40 ~ +85			$^\circ\text{C}$
Storage Temperature	T_{stg}				

A Relative Humidity between 40% and 60% is recommended in ESD-protected work areas to reduce static build up during assembly process (Reference JEDEC/JESD625-A and JEDEC/J-STD-033)

Operating Characteristics ($T_A=25^\circ\text{C}$)		Red (AlGaInP)	Green (InGaN)	Blue (InGaN)	Unit
Forward Voltage (Typ.) ($I_F=20\text{mA}$)	V_F	2.2	3.2	3.3	V
Forward Voltage (Max.) ($I_F=20\text{mA}$)	V_F	2.8	4.0	4.0	V
Reverse Current (Max.) ($V_R=5\text{V}$)	I_R	10	50	50	μA
Wavelength of Peak Emission CIE127-2007* (Typ.) ($I_F=20\text{mA}$)	λ_P	640*	520*	465*	nm
Wavelength of Dominant Emission CIE127-2007* (Typ.) ($I_F=20\text{mA}$)	λ_D	625*	525*	470*	nm
Spectral Line Full Width At Half-Maximum (Typ.) ($I_F=20\text{mA}$)	$\Delta\lambda$	20	35	22	nm
Capacitance (Typ.) ($V_F=0\text{V}$, $f=1\text{MHz}$)	C	27	100	100	pF

Part Number	Emitting Color	Emitting Material	Lens-color	Luminous Intensity CIE127-2007* ($I_F=20\text{mA}$) mcd		Wavelength CIE127-2007* nm λ_P	Viewing Angle 20 1/2
				min.	typ.		
XZM2CRKM2DGFBB45SCCB	Red	AlGaInP	Water Clear	400*	497*	640*	120°
	Green	InGaN		1000*	1590*	520*	
	Blue	InGaN		200*	327*	465*	

*Luminous intensity value and wavelength are in accordance with CIE127-2007 standards.

Handling Precautions

Compare to epoxy encapsulant that is hard and brittle, silicone is softer and flexible. Although its characteristic significantly reduces thermal stress, it is more susceptible to damage by external mechanical force.

As a result, special handling precautions need to be observed during assembly using silicone encapsulated LED products. Failure to comply might lead to damage and premature failure of the LED.

1. Handle the component along the side surfaces by using forceps or appropriate tools.

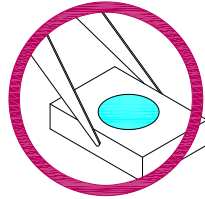

2. Do not directly touch or handle the silicone lens surface. It may damage the internal circuitry.

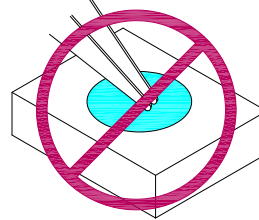
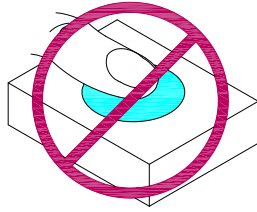

3. Do not stack together assembled PCBs containing exposed LEDs. Impact may scratch the silicone lens or damage the internal circuitry.

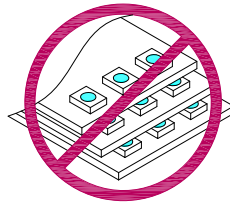

- 4.1. The inner diameter of the SMD pickup nozzle should not exceed the size of the LED to prevent air leaks.
- 4.2. A pliable material is suggested for the nozzle tip to avoid scratching or damaging the LED surface during pickup.
- 4.3. The dimensions of the component must be accurately programmed in the pick-and-place machine to insure precise pickup and avoid damage during production.

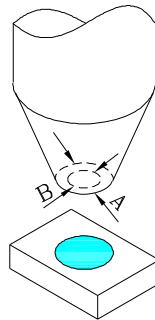

5. As silicone encapsulation is permeable to gases, some corrosive substances such as H_2S might corrode silver plating of leadframe. Special care should be taken if an LED with silicone encapsulation is to be used near such substances.

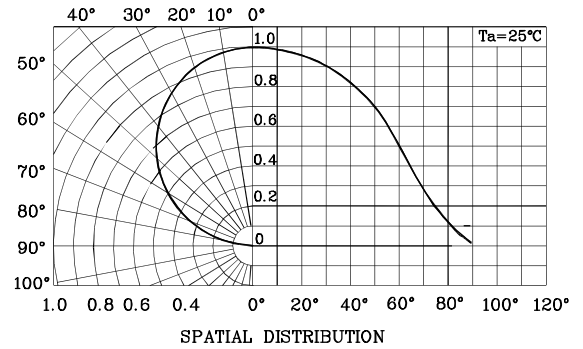
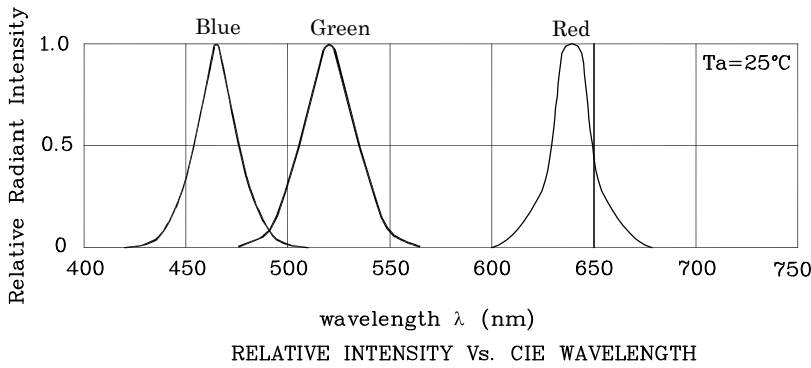

❖ Red

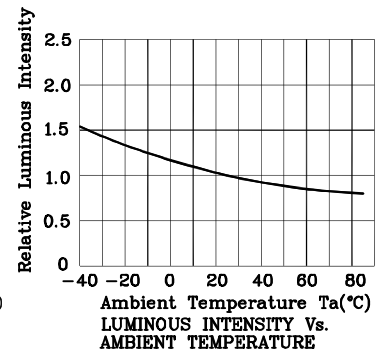
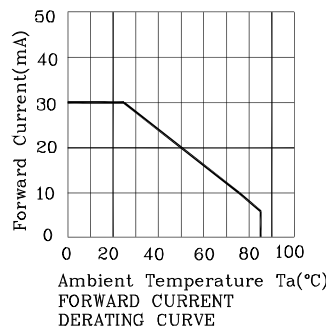
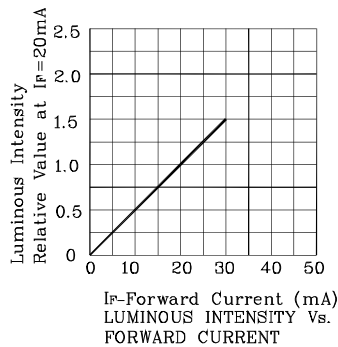
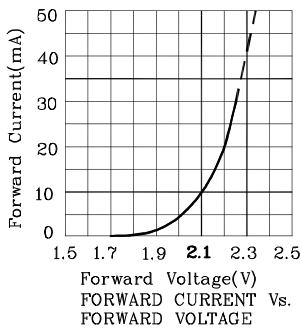

❖ Green

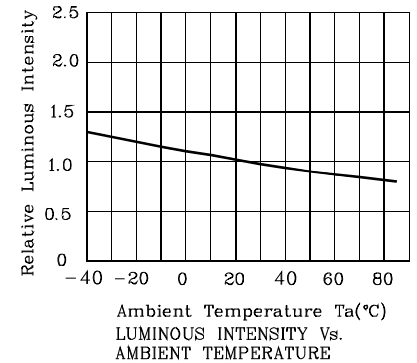
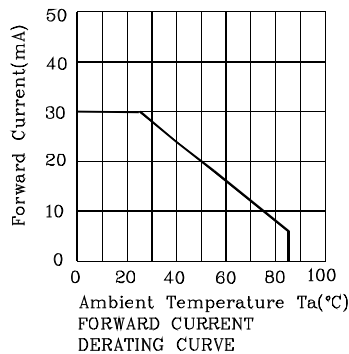
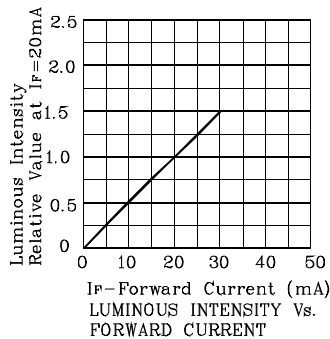
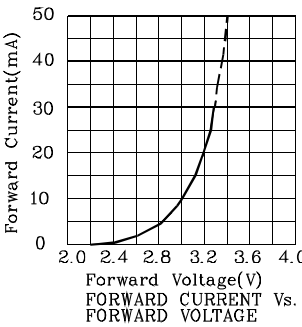

❖ Blue

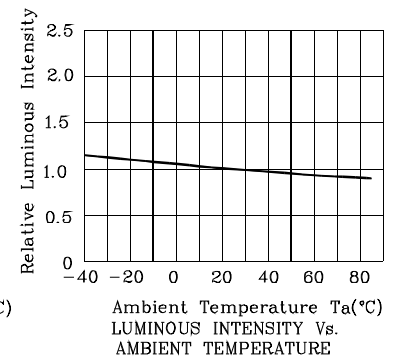
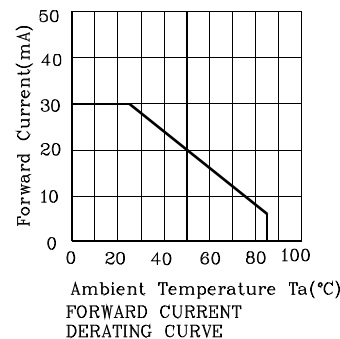
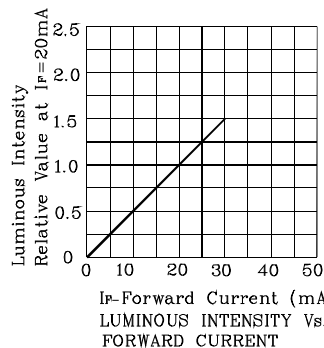
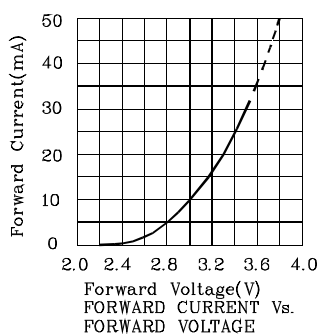

❖ LED is recommended for reflow soldering and soldering profile is shown below.

Reflow Soldering Profile for SMD Products (Pb-Free Components)

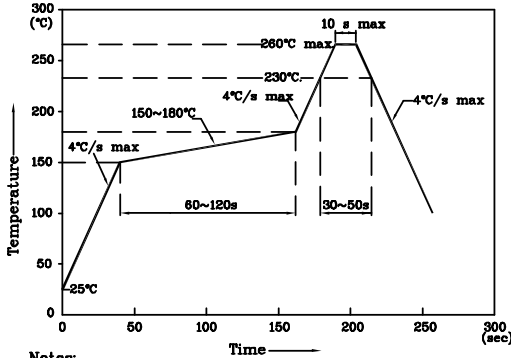

- Notes:
1. Maximum soldering temperature should not exceed 260°C
 2. Recommended reflow temperature: 145°C-260°C
 3. Do not put stress to the epoxy resin during high temperatures conditions

❖ The device has a single mounting surface. The device must be mounted according to the specifications.

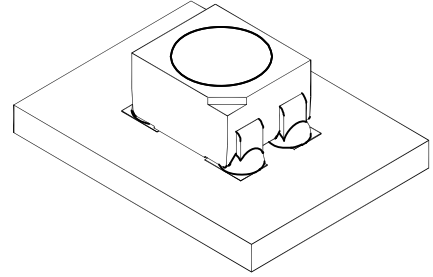

❖ Recommended Soldering Pattern (Units : mm; Tolerance: ± 0.1)

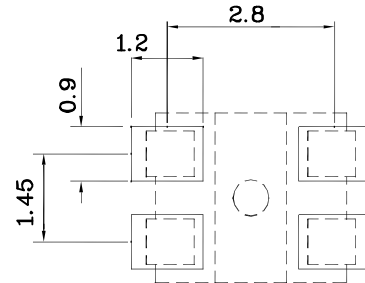

❖ Tape Specification (Units : mm)

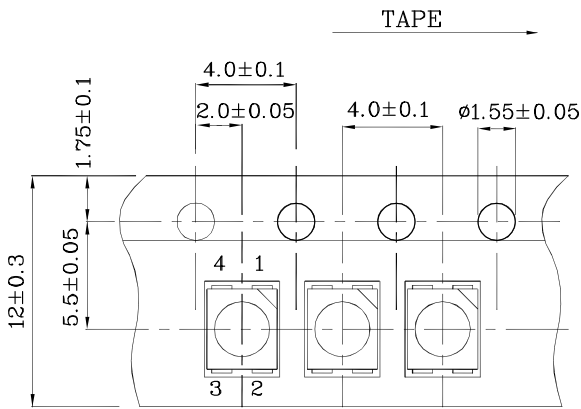

❖ Reel Dimension

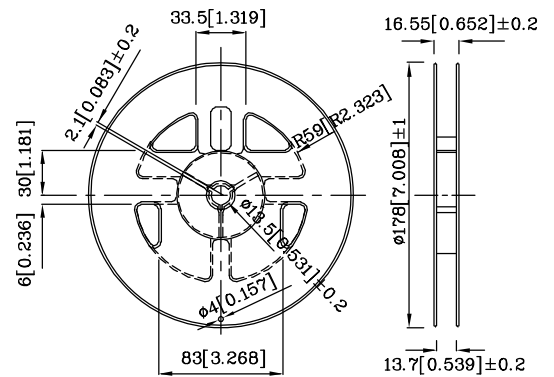

Remarks:



If special sorting is required (e.g. binning based on forward voltage, Luminous intensity / luminous flux, or wavelength), the typical accuracy of the sorting process is as follows:

1. Wavelength: +/-1nm
2. Luminous intensity / luminous flux: +/-15%
3. Forward Voltage: +/-0.1V

Note: Accuracy may depend on the sorting parameters.

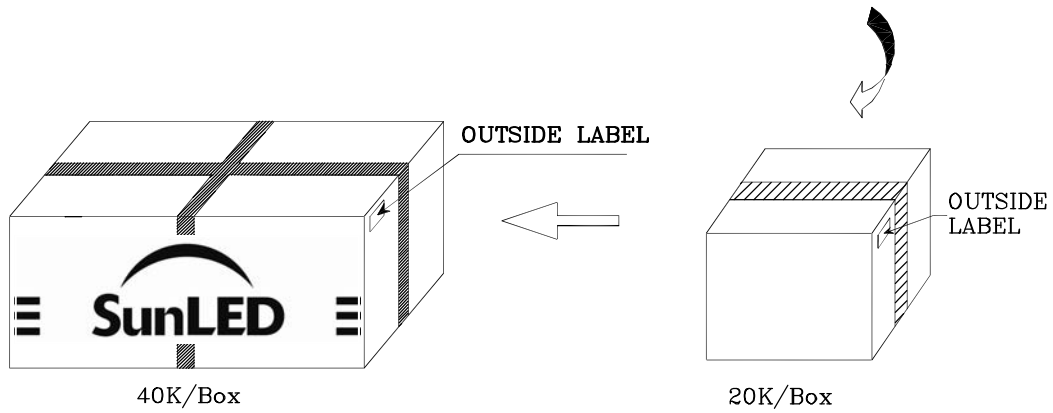
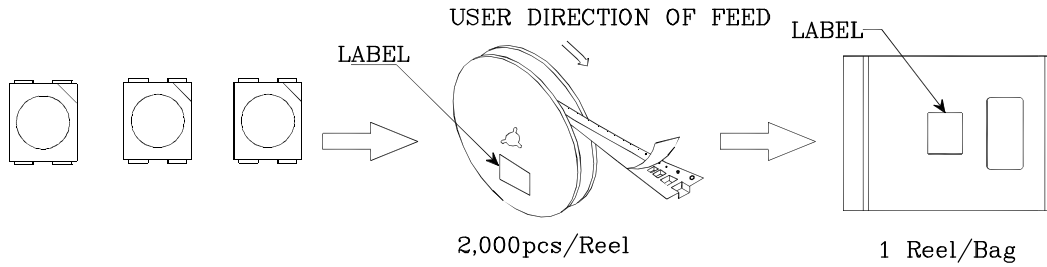
PACKING & LABEL SPECIFICATIONS



		<table border="1"> <tr><td>Q.C.</td></tr> <tr><td>Q C</td></tr> <tr><td>XX XX XXXX</td></tr> <tr><td>PASSED</td></tr> </table>	Q.C.	Q C	XX XX XXXX	PASSED
Q.C.						
Q C						
XX XX XXXX						
PASSED						
P/NO : XZxxx45x						
QTY : 2,000 pcs		CODE: XXX				
S/N : XX						
LOT NO :						
 XXXXXXXXXXXXXXXXXXXXXXXXXXXX						
RoHS Compliant						

TERMS OF USE

1. Data presented in this document reflect statistical figures and should be treated as technical reference only.
2. Contents within this document are subject to improvement and enhancement changes without notice.
3. The product(s) in this document are designed to be operated within the electrical and environmental specifications indicated on the datasheet. User accepts full risk and responsibility when operating the product(s) beyond their intended specifications.
4. The product(s) described in this document are intended for electronic applications in which a person's life is not reliant upon the LED. Please consult with a SunLED representative for special applications where the LED may have a direct impact on a person's life.
5. The contents within this document may not be altered without prior consent by SunLED.
6. Additional technical notes are available at <http://www.SunLEDusa.com/TechnicalNotes.asp>