

■ Features

- Low forward voltage drop.
- Excellent high temperature stability.
- Fast switching capability.
- Suffix "G" indicates Halogen-free part, ex. CSF20L200CTG-A.
- Lead-free parts meet environmental standards of MIL-STD-19500 /228

■ Mechanical data

- Epoxy : UL94-V0 rated flame retardant.
- Case : JEDEC ITO-220AB molded plastic body.
- Terminals : Solder plated, solderable per MIL-STD-750, Method 2026.
- Polarity: As marked.
- Mounting Position : Any.
- Weight : Approximated 2.25 gram.

■ Maximum ratings and electrical characteristics

Rating at 25°C ambient temperature unless otherwise specified. Single phase, half wave, 60Hz, resistive or inductive load. For capacitive load, derate current by 20%.

■ Outline

ITO-220AB

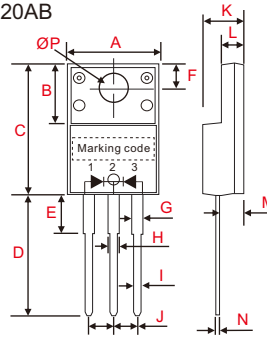

symbol	Dimensions in inches(millimeters)	
	Min	Max
A	0.390(9.9)	0.408(10.36)
B	0.268(6.8)	0.283(7.2)
C	0.583(14.8)	0.598(15.2)
D	0.512(13.0)	0.543(13.8)
E	0.102(2.6)	0.150(3.8)
F	0.101(2.55)	0.112(2.85)
G	0.043(1.1)	0.053(1.35)
H	0.043(1.1)	0.053(1.35)
I	0.020(0.5)	0.028(0.7)
J	0.098(2.49)	0.102(2.59)
K	0.169(4.3)	0.185(4.7)
L	0.112(2.85)	0.128(3.25)
M	0.098(2.5)	0.114(2.9)
N	0.020(0.5)	0.028(0.7)
ØP	0.130(3.3)	0.134(3.5)

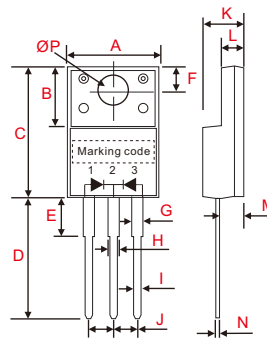

Alternate

symbol	Dimensions in inches(millimeters)	
	Min	Max
A	0.383(9.72)	0.404(10.27)
B	0.248(6.3)	0.272(6.9)
C	0.571(14.5)	0.610(15.5)
D	0.516(13.1)	0.547(13.9)
E	-	0.161(4.1)
F	0.094(2.4)	0.126(3.2)
G	0.039(1.0)	0.051(1.3)
H	0.039(1.0)	0.051(1.3)
I	0.020(0.5)	0.035(0.9)
J	0.095(2.41)	0.105(2.67)
K	0.169(4.3)	0.189(4.8)
L	0.055(1.4)	0.122(3.1)
M	0.091(2.3)	0.117(2.96)
N	0.014(0.35)	0.031(0.8)
ØP	0.122(3.1)	0.142(3.6)

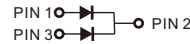

Parameter	Conditions	Symbol	CSF20L200CT-A	UNIT		
Marking code			CSF20L200CT			
Peak repetitive reverse voltage		V_{RRM}				
Working peak reverse voltage		V_{RWM}	200	V		
DC blocking voltage		V_{RM}				
Forward rectified current (total device)		I_O	20	A		
Forward surge current (per diode)	8.3ms single half sine-wave superimposed on rate load (JEDEC method)	I_{FSM}	250	A		
Peak repetitive reverse surge current (per diode)	2us - 1kHz	I_{RRM}	3	A		
Thermal resistance(1) (per diode)	Junction to case	R_{BJC}	4	°C/W		
Operating and Storage temperature		T_J, T_{STG}	-65 ~ +175	°C		
Parameter	Conditions	Symbol	MIN.	TYP.	MAX.	UNIT
Forward voltage drop (per diode)	$I_F = 10A, T_J = 25^\circ C$	V_F			860	mV
	$I_F = 10A, T_J = 125^\circ C$			660	720	
	$I_F = 20A, T_J = 25^\circ C$				960	
Reverse current (per diode)	$V_R = V_{RRM}, T_J = 25^\circ C$	I_R			0.1	mA
	$V_R = V_{RRM}, T_J = 125^\circ C$				10	
Reverse recovery time (per diode)	$I_F = 0.5A, I_R = 1A, I_{RR} = 0.25A$	t_{rr}		24	30	ns
	$I_F = 1A, V_R = 30V, di/dt = 100A/us, T_J = 25^\circ C$			20	25	

Note : 1. Thermal resistance from junction to case per leg, with heatsink size(1.35" x 0.95" x 0.18") Al-plate.

■ Rating and characteristic curves

Fig. 1 - Forward Power Dissipation (per diode)

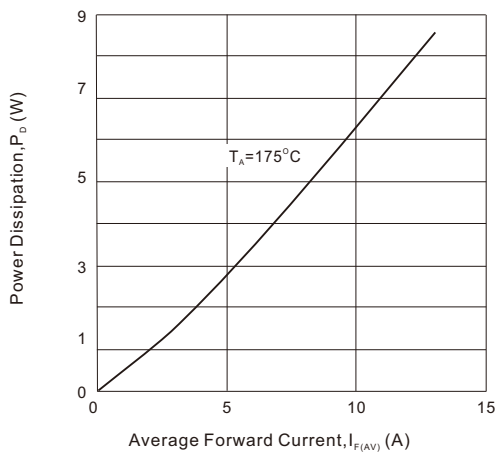

Fig. 2 - Instantaneous Forward Characteristics (per diode)

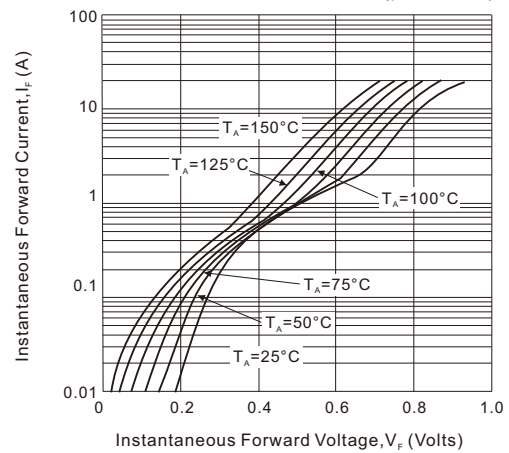

Fig. 3 - Reverse Characteristics (per diode)

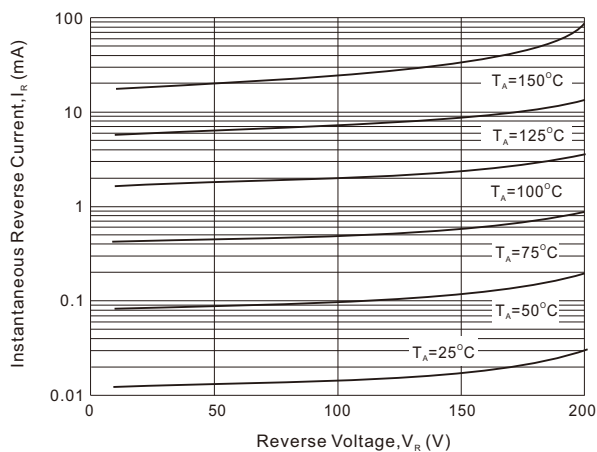
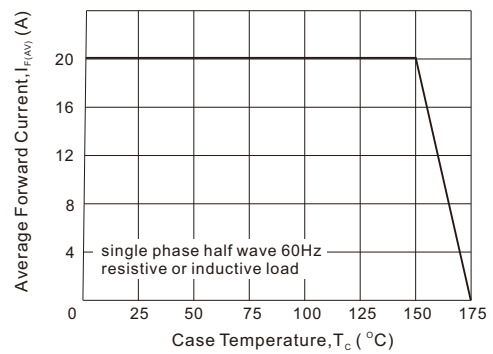

Fig. 4 - Forward Current Derating Curve (total device)



- CITC reserves the right to make changes to this document and its products and specifications at any time without notice.
- Customers should obtain and confirm the latest product information and specifications before final design, purchase or use.
- CITC makes no warranty, representation or guarantee regarding the suitability of its products for any particular purpose, nor does CITC assume any liability for application assistance or customer product design.
- CITC does not warrant or accept any liability with products which are purchased or used for any unintended or unauthorized application.
- No license is granted by implication or otherwise under any intellectual property rights of CITC.
- CITC products are not authorized for use as critical components in life support devices or systems without express written approval of CITC.