

GaAs INTEGRATED CIRCUIT

μ PG100P, μ PG101P

WIDE BAND AMPLIFIER CHIPS

DESCRIPTION

μ PG100P and μ PG101P are GaAs integrated circuits designed as wide band amplifiers. Both devices are available in chip form.

μ PG100P is low noise amplifier from 50 MHz to 3 GHz and μ PG101P is a medium power amplifier in the same frequency band. These devices are most suitable for the IF stage of microwave communication system and the measurement equipment.

FEATURES

- Wide band : $f = 50 \text{ MHz to } 3 \text{ GHz}$

ORDERING INFORMATION

PART NUMBER	FORM
μ PG100P	chip
μ PG101P	chip

ABSOLUTE MAXIMUM RATINGS ($T_A = 25 \text{ }^\circ\text{C}$)

		μ PG100P	μ PG101P	
Drain Voltage	V_{DD}	+8	+10	V
Gate Voltage	V_{GG}	-8	-8	V
Input Voltage	V_{in}	-3 to +0.6	-5 to +0.6	V
Input Power	P_{in}	+15	+15	dBm
Total Power Dissipation	P_{tot}^{*1}	1.5	1.5	W
Operating Temperature	T_{opr}^{*2}	-65 to +125	-65 to +125	$^\circ\text{C}$
Storage Temperature	T_{stg}	-65 to +175	-65 to +175	$^\circ\text{C}$

*1 Mounted with AuSn hard solder

*2 The temperature of base material beside the chip

ELECTRICAL CHARACTERISTICS (T_A = 25 °C)^{*3}

μPG100P (V_{DD} = +5 V, V_{GG} = -5 V)

CHARACTERISTICS	SYMBOL	MIN.	TYP.	MAX.	UNIT	TEST CONDITIONS
Drain Current	I _{DD}	30	45	60	mA	RF OFF
Gate Current	I _{GG}		0.7	1.5	mA	
Power Gain	G _p	14	16		dB	f = 0.05 to 3 GHz
Gain Flatness	ΔG _p			±1.5	dB	
Noise Figure	NF		2.7	3.5	dB	
Input Return Loss	RL _{in}	7	10		dB	
Output Return Loss	RL _{out}	7	10		dB	
Isolation	ISOL	30	40		dB	
Output Power at 1 dB Gain Compression Point	P _{O(1 dB)}	+3	+6		dBm	

μPG101P (V_{DD} = +8 V, V_{GG} = -5 V)

CHARACTERISTICS	SYMBOL	MIN.	TYP.	MAX.	UNIT	TEST CONDITIONS
Drain Current	I _{DD}	70	100	140	mA	RF OFF
Gate Current	I _{GG}		1.0	3.0	mA	
Power Gain	G _p	12	14		dB	f = 0.05 to 3 GHz
Gain Flatness	ΔG _p			±1.5	dB	
Noise Figure	NF		5	7	dB	
Input Return Loss	RL _{in}	6	8		dB	
Output Return Loss	RL _{out}	6	8		dB	
Isolation	ISOL	30	40		dB	
Output Power at 1 dB Gain Compression Point	P _{O(1 dB)}	+16	+18		dBm	

*3 These characteristics are based on performance of devices mounted in the standard package shown in Fig. 1.

Fig. 1 8 Pin Ceramic Package

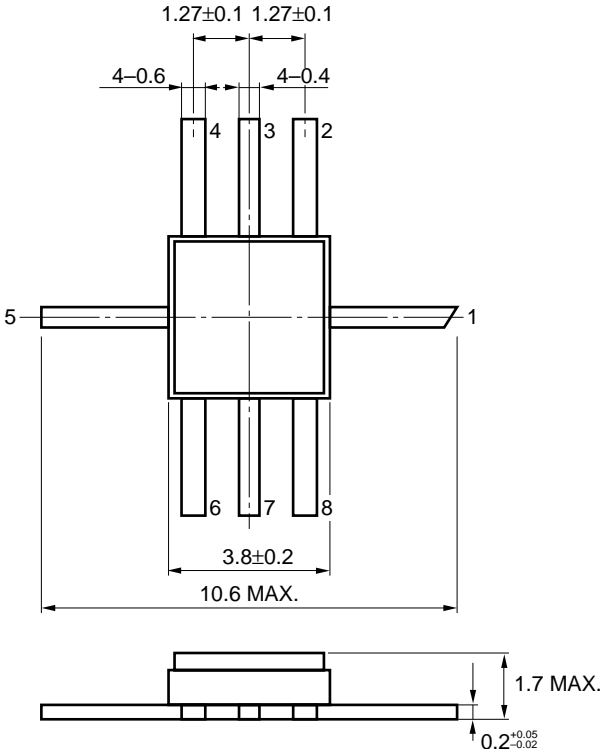

TYPICAL CHARACTERISTICS⁴

μ PG100P ($V_{DD} = +5$ V, $V_{GG} = -5$ V)

POWER GAIN AND NOISE FIGURE vs. FREQUENCY

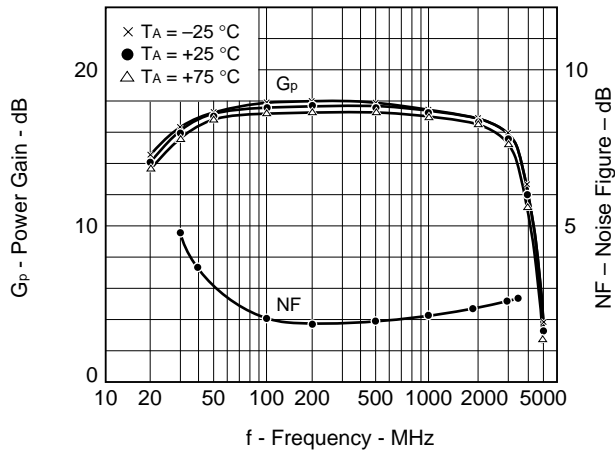

INPUT AND OUTPUT RETURN LOSS vs. FREQUENCY

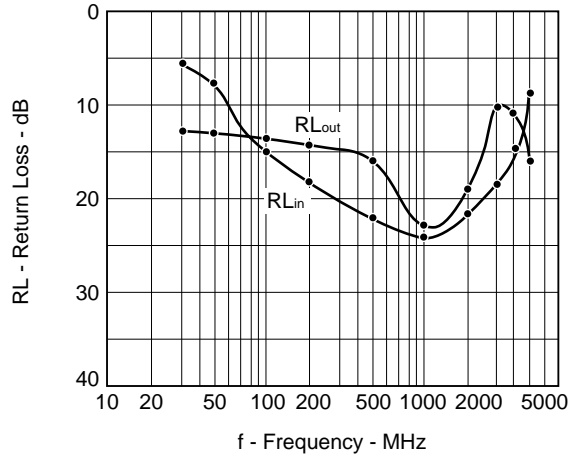

ISOLATION vs. FREQUENCY

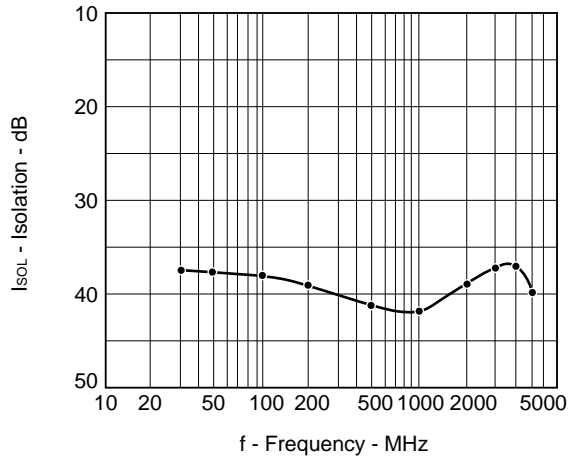

OUTPUT POWER vs. INPUT POWER

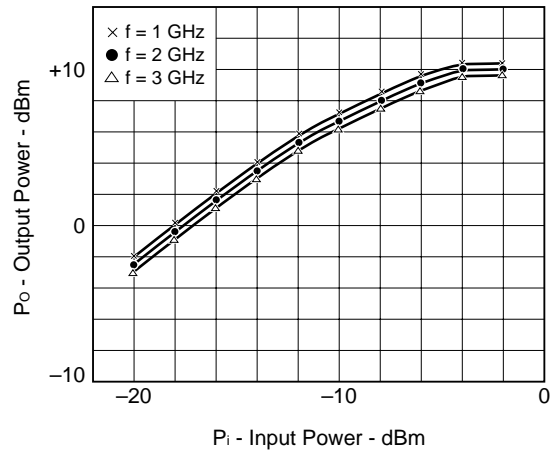

μ PG101P ($V_{DD} = +8\text{ V}$, $V_{GG} = -5\text{ V}$)

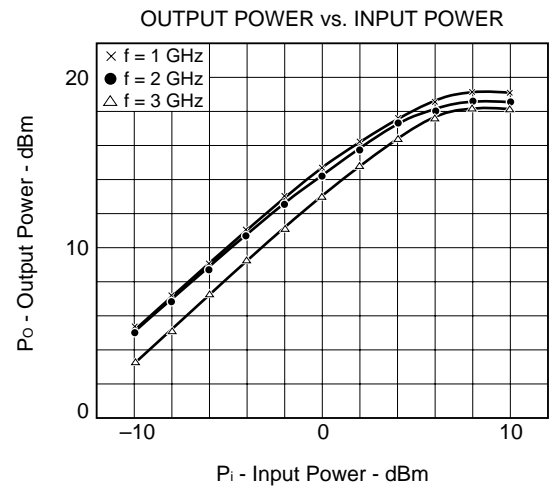
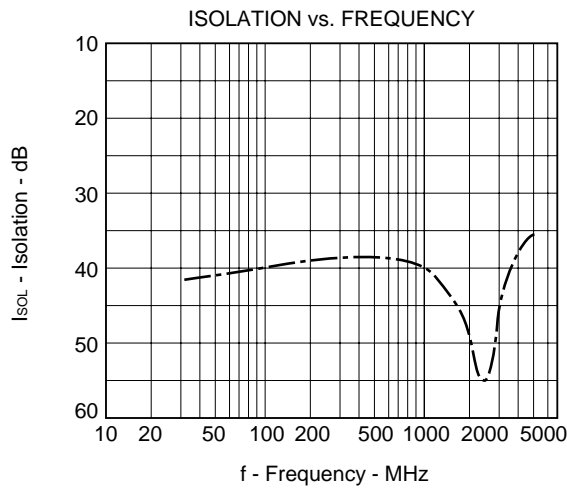
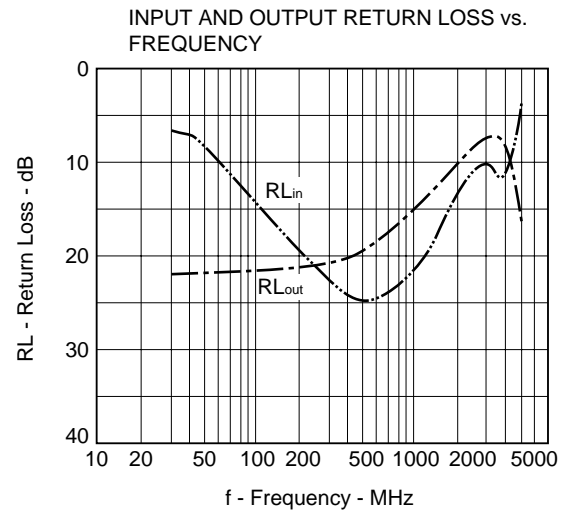
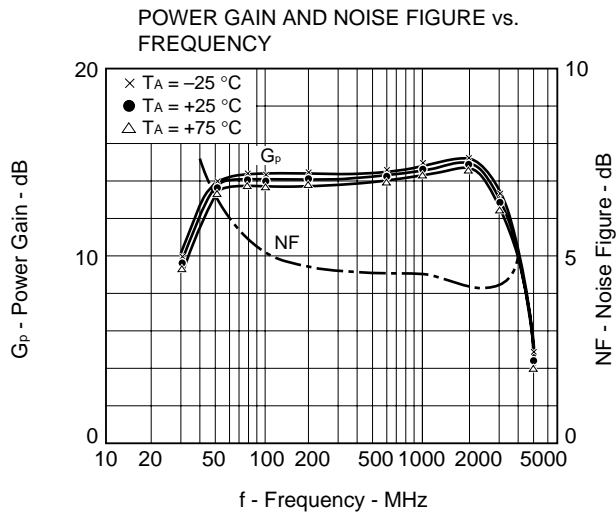

*4 These characteristics are measured for device mounted in the standard package shown in Fig. 1.

CHIP DIMENSIONS (Unit : mm)

μ PG100P

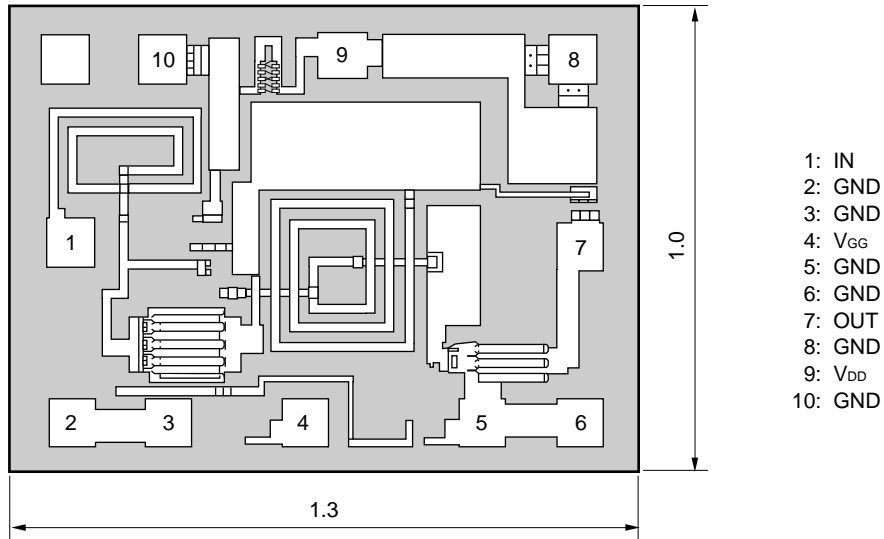

- 1: IN
- 2: GND
- 3: GND
- 4: V_{GG}
- 5: GND
- 6: GND
- 7: OUT
- 8: GND
- 9: V_{DD}
- 10: GND

Bonding Pad Size: 100 μ m \times 100 μ m

μ PG101P

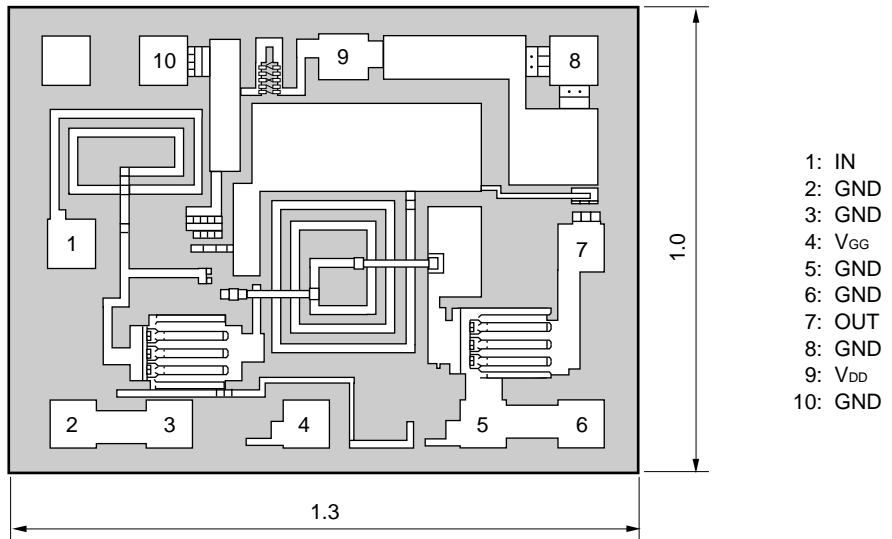

- 1: IN
- 2: GND
- 3: GND
- 4: V_{GG}
- 5: GND
- 6: GND
- 7: OUT
- 8: GND
- 9: V_{DD}
- 10: GND

Bonding Pad Size: 100 μ m \times 100 μ m

RECOMMENDED CHIP ASSEMBLY CONDITIONS

Die Attachment

- Atmosphere : N₂ gas
 - Temperature : 320 ±5 °C
 - AuSn Preform : 0.5 × 0.5 × 0.05^t (mm), 2 pcs.
 - * The hard solder such as AuSi or AuGe which has higher melting point than AuSn should not be used.
 - Base Material : CuW, Cu, KV
 - * Other material should not be used.
- Epoxy Die Attach is not recommended.

Bonding

- Machine : TCB
 - * USB is not recommended
- Wire : 30 μm diameter Au wire
- Temperature : 260 ±5 °C
- Strength : 31 ±3 g
- Atmosphere : N₂ gas

QUALITY ASSURANCE (Refer to GET-30116)

1. 100 % Tests

- 1-1 100 % DC and RF Probe
- 1-2 Visual Inspection
 - MIL-STD-883/Method 2010 Condition B

2. Tests on Sampling Basis

- 2-1 Bond Pull Tests (In case of recommended chip handling)
 - MIL-STD-883 Method 2011
 - 5 samples/wafer and 20 points tested
 - Accept 0/Reject 1
- 2-2 Tests in Standard Package
 - Test the electrical characteristics of chips assembled into the standard package used for μPG100B and μPG101B.
 - 5 samples/wafer tested
 - DC and RF measurement Accept 1/Reject 2

3. WARRANTY

NEC has a responsibility of quality assurance for the products within 180 days after delivered to customers where these are handled properly and stored in the desiccator with the flow of dry N₂ gas.

4. CAUTION

- 4-1 Take great care to prevent static electricity.
- 4-2 Be sure that Die Attach is performed in N₂ atmosphere.

No part of this document may be copied or reproduced in any form or by any means without the prior written consent of NEC Corporation. NEC Corporation assumes no responsibility for any errors which may appear in this document.

NEC Corporation does not assume any liability for infringement of patents, copyrights or other intellectual property rights of third parties by or arising from use of a device described herein or any other liability arising from use of such device. No license, either express, implied or otherwise, is granted under any patents, copyrights or other intellectual property rights of NEC Corporation or others.

While NEC Corporation has been making continuous effort to enhance the reliability of its semiconductor devices, the possibility of defects cannot be eliminated entirely. To minimize risks of damage or injury to persons or property arising from a defect in an NEC semiconductor device, customers must incorporate sufficient safety measures in its design, such as redundancy, fire-containment, and anti-failure features.

NEC devices are classified into the following three quality grades:

"Standard", "Special", and "Specific". The Specific quality grade applies only to devices developed based on a customer designated "quality assurance program" for a specific application. The recommended applications of a device depend on its quality grade, as indicated below. Customers must check the quality grade of each device before using it in a particular application.

Standard: Computers, office equipment, communications equipment, test and measurement equipment, audio and visual equipment, home electronic appliances, machine tools, personal electronic equipment and industrial robots

Special: Transportation equipment (automobiles, trains, ships, etc.), traffic control systems, anti-disaster systems, anti-crime systems, safety equipment and medical equipment (not specifically designed for life support)

Specific: Aircrafts, aerospace equipment, submersible repeaters, nuclear reactor control systems, life support systems or medical equipment for life support, etc.

The quality grade of NEC devices is "Standard" unless otherwise specified in NEC's Data Sheets or Data Books. If customers intend to use NEC devices for applications other than those specified for Standard quality grade, they should contact an NEC sales representative in advance.

Anti-radioactive design is not implemented in this product.