

## Bridge Rectifiers

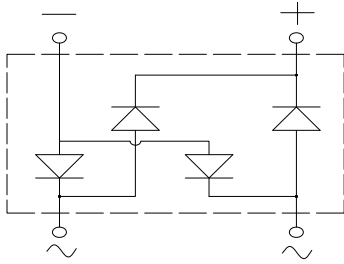
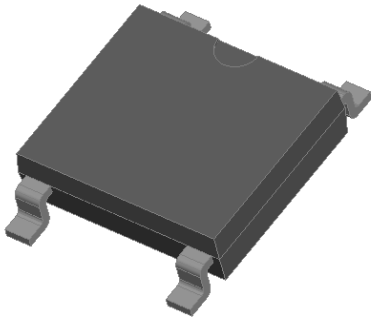

### Features

- UL recognition, file #E313149
- Ideal for automated placement
- High surge current capability
- Meets MSL level 1, per J-STD-020, LF maximum peak of 260 °C
- Schottky chip

### Typical Applications

General purpose use in high frequency bridge full wave rectification for SMPS, lighting ballast, adapter, battery charger, home appliances, office equipment, and telecommunication applications.

### Mechanical Data

- **Package:** ABS  
Molding compound meets UL 94 V-0 flammability rating, RoHS-compliant, Halogen free
- **Terminals:** Tin plated leads, solderable per J-STD-002 and JESD22-B102
- **Polarity:** As marked on body

### ■ Maximum Ratings (T<sub>a</sub>=25°C Unless otherwise specified)

PARAMETER	SYMBOL	UNIT	ABSK12S	ABSK14S	ABSK16S	ABSK18S	ABSK110S
Device marking code			ABSK12S	ABSK14S	ABSK16S	ABSK18S	ABSK110S
Repetitive peak reverse voltage	VRRM	V	20	40	60	80	100
Average rectified output current @60Hz sine wave, R-load, T <sub>a</sub> =40°C, on Alumina Substrate	I <sub>O</sub>	A	1				
Surge(non-repetitive)forward current @60 Hz half sine wave, 1 cycle, T <sub>j</sub> =25°C	I <sub>FSM</sub>	A	30				
Current squared time @1ms≤t≤8.3ms T <sub>j</sub> =25°C, Rating of per diode	I <sup>2</sup> t	A <sup>2</sup> s	3.7				
Storage temperature	T <sub>stg</sub>	°C	-55 ~+150				
Junction temperature	T <sub>j</sub>	°C	-55 ~+150				

### ■ Electrical Characteristics (T<sub>a</sub>=25°C Unless otherwise specified)

PARAMETER	SYMBOL	UNIT	TEST CONDITIONS	ABSK12S	ABSK14S	ABSK16S	ABSK18S	ABSK110S
Maximum instantaneous forward voltage drop per diode	V <sub>F</sub>	V	I <sub>FM</sub> =0.5A	0.55		0.65	0.85	
Maximum DC reverse current at rated DC blocking voltage per diode	I <sub>RRM</sub>	mA	V <sub>RM</sub> =VRRM	0.5				



# ABSK12S THRU ABSK110S

## Thermal Characteristics (T<sub>a</sub>=25°C Unless otherwise specified)

PARAMETER		SYMBOL	UNIT	ABSK12S	ABSK14S	ABSK16S	ABSK18S	ABSK110S
Thermal Resistance	Between junction and ambient, On alumina substrate	R <sub>θJ-A</sub>	°C/W	76				
	Between junction and ambient, On glass-epoxi substrate			134				
	Between junction and lead	R <sub>θJ-L</sub>		20				

## Ordering Information (Example)

PREFERRED P/N	PACKING CODE	UNIT WEIGHT(g)	MINIIMUM PACKAGE(pcs)	INNER BOX QUANTITY(pcs)	OUTER CARTON QUANTITY(pcs)	DELIVERY MODE
ABSK12S-ABSK110S	F1	Approximate 0.095	4000	8000	64000	13" reel

## Characteristics (Typical)

FIG1: I<sub>o</sub>-T<sub>A</sub> Curve

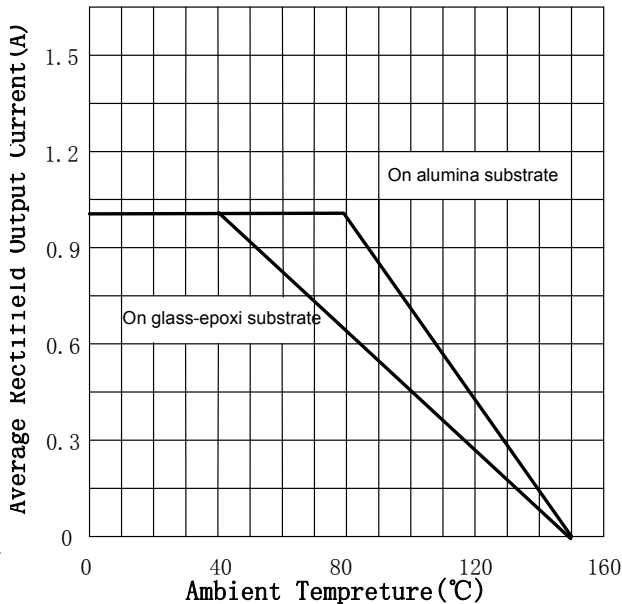

FIG2: Surge Forward Current Capability

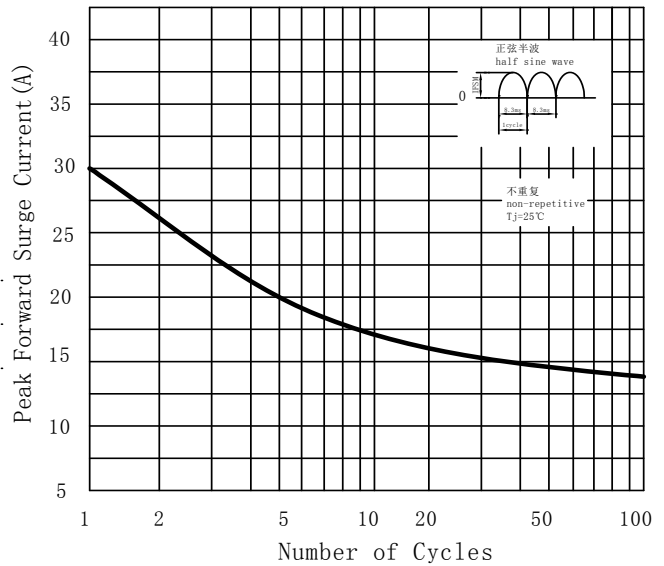

FIG3: Forward Voltage

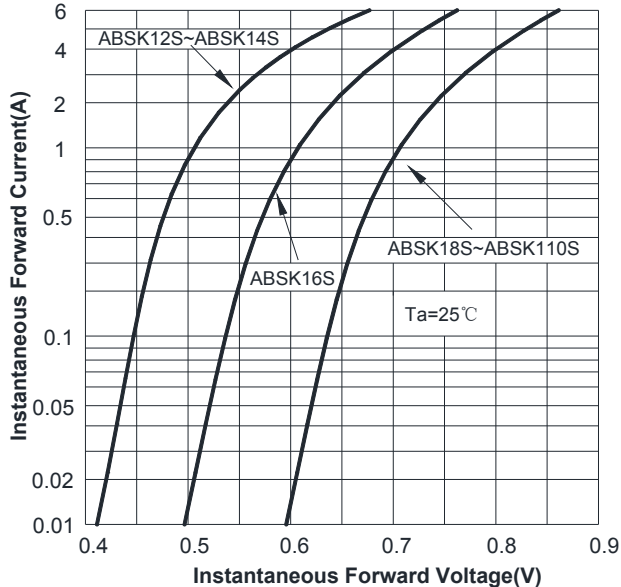
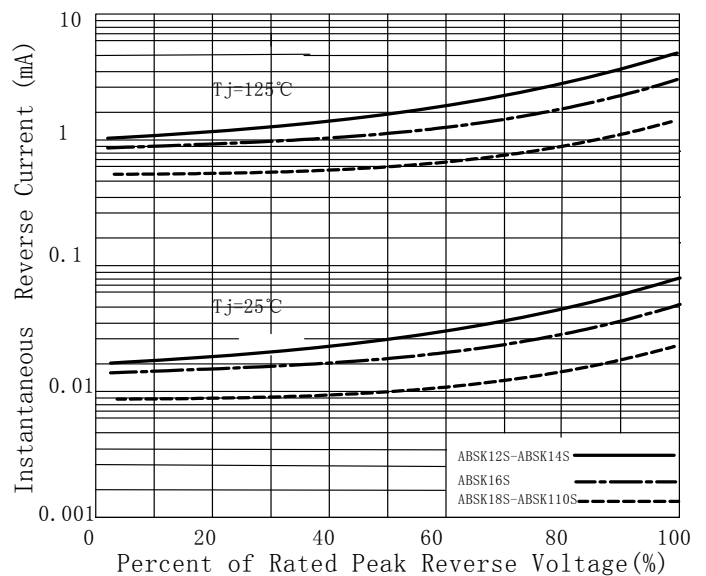

FIG4: Typical Reverse Characteristics





# ABSK12S THRU ABSK110S

## ■ Outline Dimensions

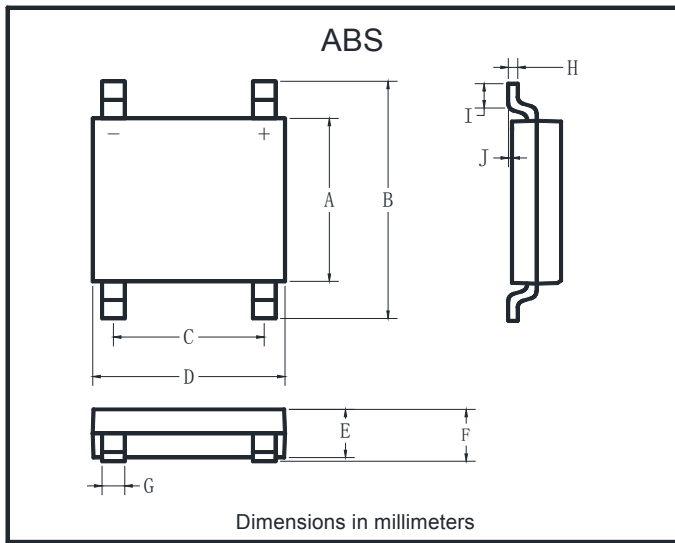

ABS		
Dim	Min	Max
A	4.30	4.50
B	6.00	6.40
C	3.90	4.10
D	4.90	5.10
E	1.25	1.45
F	1.60 Max	
G	0.60	0.70
H	0.15	0.25
I	0.30	0.80
J	0.02	0.15

## ■ Suggested pad layout

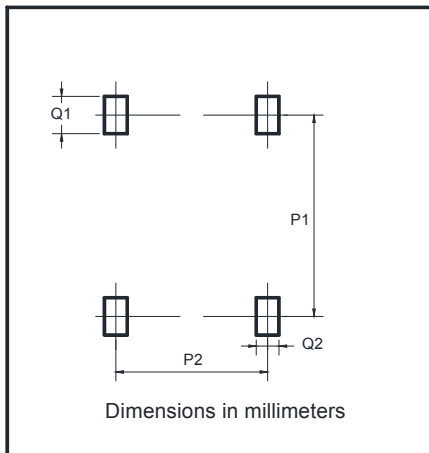

Dim	Min
P1	5.72
P2	4.00
Q1	1.00
Q2	0.90



## ABSK12S THRU ABSK110S

---

### Disclaimer

The information presented in this document is for reference only. Yangzhou Yangjie Electronic Technology Co., Ltd. reserves the right to make changes without notice for the specification of the products displayed herein to improve reliability, function or design or otherwise.

The product listed herein is designed to be used with ordinary electronic equipment or devices, and not designed to be used with equipment or devices which require high level of reliability and the malfunction of which would directly endanger human life (such as medical instruments, transportation equipment, aerospace machinery, nuclear-reactor controllers, fuel controllers and other safety devices), Yangjie or anyone on its behalf, assumes no responsibility or liability for any damages resulting from such improper use of sale.

This publication supersedes & replaces all information previously supplied. For additional information, please visit our website [http:// www.21yangjie.com](http://www.21yangjie.com) , or consult your nearest Yangjie's sales office for further assistance.