

MAIN FEATURES:

Symbol	Value	Unit
$I_{T(RMS)}$	6	A
V_{DRM}/V_{RRM}	600 and 800	V
$I_G(Q_1)$	5 to 50	mA

DESCRIPTION

Suitable for AC switching operations, the BTA/BTB06 series can be used as an ON/OFF function in applications such as static relays, heating regulation, induction motor starting circuits... or for phase control in light dimmers, motor speed controllers,...

The snubberless and logic level versions (BTA/BTB...W) are specially recommended for use on inductive loads, thanks to their high commutation performances. By using an internal ceramic pad, the BTA series provides voltage insulated tab (rated at 2500V RMS) complying with UL standards (File ref.: E81734)

TO-220AB Insulated (BTA06)

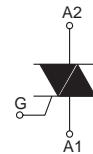
TO-220AB (BTB06)

ABSOLUTE MAXIMUM RATINGS

Symbol	Parameter		Value	Unit	
$I_{T(RMS)}$	RMS on-state current (full sine wave)	TO-220AB	$T_c = 110^\circ\text{C}$	6	A
		TO-220AB Ins.	$T_c = 105^\circ\text{C}$		
I_{TSM}	Non repetitive surge peak on-state current (full cycle, T_j initial = 25°C)	F = 50 Hz	t = 20 ms	60	A
		F = 60 Hz	t = 16.7 ms	63	
I^2t	I^2t Value for fusing	tp = 10 ms		21	A^2s
dl/dt	Critical rate of rise of on-state current $I_G = 2 \times I_{GT}$, tr ≤ 100 ns	F = 120 Hz	$T_j = 125^\circ\text{C}$	50	A/μs
I_{GM}	Peak gate current	tp = 20 μs	$T_j = 125^\circ\text{C}$	4	A
$P_{G(AV)}$	Average gate power dissipation		$T_j = 125^\circ\text{C}$	1	W
T_{stg} T_j	Storage junction temperature range Operating junction temperature range			- 40 to + 150 - 40 to + 125	$^\circ\text{C}$

■ SNUBBERLESS™ and LOGIC LEVEL (3 Quadrants)

Symbol	Test Conditions	Quadrant		BTA/BTB06				Unit
				TW	SW	CW	BW	
$I_{GT}(1)$	$V_D = 12\text{ V}$ $R_L = 30\ \Omega$	I - II - III	MAX.	5	10	35	50	mA
V_{GT}			MAX.	1.3				V
V_{GD}	$V_D = V_{DRM}$ $R_L = 3.3\ \text{k}\Omega$ $T_j = 125^\circ\text{C}$	I - II - III	MIN.	0.2				V
$I_H(2)$	$I_T = 100\ \text{mA}$		MAX.	10	15	35	50	mA
I_L	$I_G = 1.2 I_{GT}$	I - III	MAX.	10	25	50	70	mA
		II		15	30	60	80	
$dV/dt(2)$	$V_D = 67\% V_{DRM}$ gate open $T_j = 125^\circ\text{C}$		MIN.	20	40	400	1000	V/ μs
$(dI/dt)c(2)$	$(dV/dt)c = 0.1\ \text{V}/\mu\text{s}$ $T_j = 125^\circ\text{C}$		MIN.	2.7	3.5	-	-	A/ms
	$(dV/dt)c = 10\ \text{V}/\mu\text{s}$ $T_j = 125^\circ\text{C}$			1.2	2.4	-	-	
	Without snubber $T_j = 125^\circ\text{C}$			-	-	3.5	5.3	

■ STANDARD (4 Quadrants)

Symbol	Test Conditions	Quadrant		BTA/BTB06		Unit
				C	B	
$I_G(1)$	$V_D = 12\text{ V}$ $R_L = 30\ \Omega$	I - II - III IV	MAX.	25 50	50 100	mA
V_{GT}			ALL	MAX.	1.3	
V_{GD}	$V_D = V_{DRM}$ $R_L = 3.3\ \text{k}\Omega$ $T_j = 125^\circ\text{C}$	ALL	MIN.	0.2		V
$I_H(2)$	$I_T = 500\ \text{mA}$		MAX.	25	50	mA
I_L	$I_G = 1.2 I_{GT}$	I - III - IV	MAX.	40	50	mA
		II		80	100	
$dV/dt(2)$	$V_D = 67\% V_{DRM}$ gate open $T_j = 125^\circ\text{C}$		MIN.	200	400	V/ μs
$(dV/dt)c(2)$	$(dI/dt)c = 2.7\ \text{A}/\text{ms}$ $T_j = 125^\circ\text{C}$		MIN.	5	10	V/ μs

STATIC CHARACTERISTICS

Symbol	Test Conditions		Value	Unit
$V_T(2)$	$I_{TM} = 5.5\ \text{A}$	$t_p = 380\ \mu\text{s}$	$T_j = 25^\circ\text{C}$ MAX.	1.55 V
$V_{to}(2)$	Threshold voltage		$T_j = 125^\circ\text{C}$ MAX.	0.85 V
$R_d(2)$	Dynamic resistance		$T_j = 125^\circ\text{C}$ MAX.	60 $\text{m}\Omega$
I_{DRM} I_{RRM}	$V_{DRM} = V_{RRM}$		$T_j = 25^\circ\text{C}$ MAX.	5 μA
			$T_j = 125^\circ\text{C}$ MAX.	1 mA

Note 1: minimum IGT is guaranteed at 5% of IGT max.

Note 2: for both polarities of A2 referenced to A1

THERMAL RESISTANCES

Symbol	Parameter	Value	Unit
$R_{th(j-c)}$	Junction to case (AC)	TO-220AB	1.8
		TO-220AB Insulated	2.7
$R_{th(j-a)}$	Junction to ambient	TO-220AB	60
		TO-220AB Insulated	

PRODUCT SELECTOR

Part Number	Voltage (xxx)		Sensitivity	Type	Package
	600 V	800 V			
BTA/BTB06-xxxB	X	X	50 mA	Standard	TO-220AB
BTA/BTB06-xxxBW	X	X	50 mA	Snubberless	TO-220AB
BTA/BTB06-xxxC	X	X	25 mA	Standard	TO-220AB
BTA/BTB06-xxxCW	X	X	35 mA	Snubberless	TO-220AB
BTA/BTB06-xxxSW	X	X	10 mA	Logic level	TO-220AB
BTA/BTB06-xxxTW	X	X	5 mA	Logic level	TO-220AB

BTB: non insulated TO-220AB package

ORDERING INFORMATION

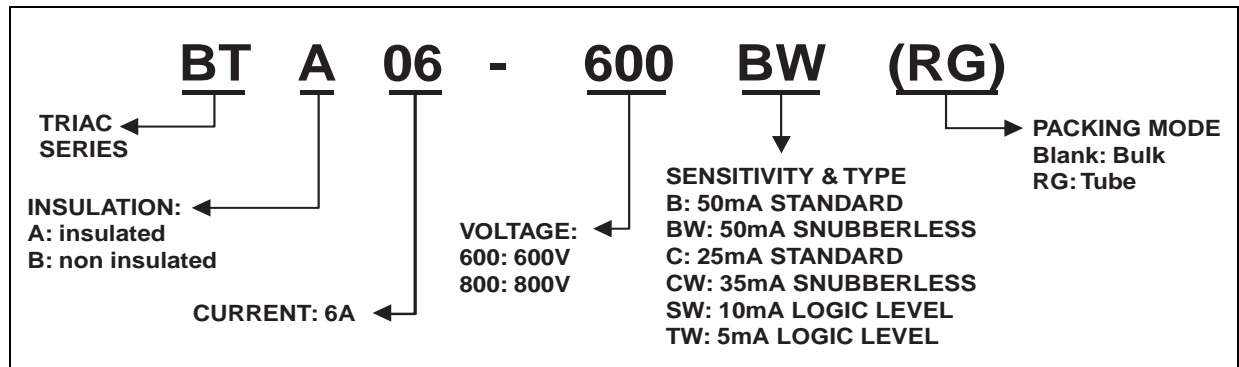

OTHER INFORMATION

Part Number	Marking	Weight	Base quantity	Packing mode
BTA/BTB06-xxxyz	BTA/BTB06-xxxyz	2.3 g	250	Bulk
BTA/BTB06-xxxyzRG	BTA/BTB06-xxxyz	2.3 g	50	Tube

Note: xxx = voltage, y = sensitivity, z = type

Fig. 1: Maximum power dissipation versus RMS on-state current (full cycle).

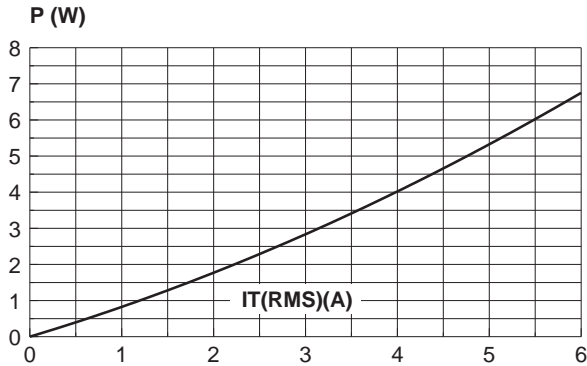

Fig. 3: Relative variation of thermal impedance versus pulse duration.

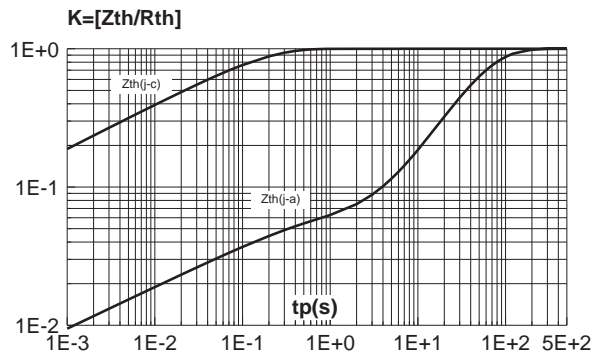

Fig. 5: Surge peak on-state current versus number of cycles.

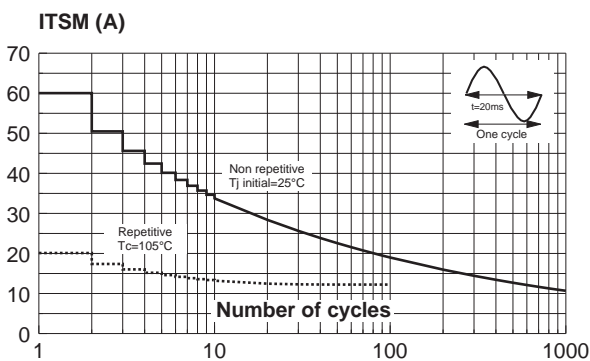

Fig. 2: RMS on-state current versus case temperature (full cycle).

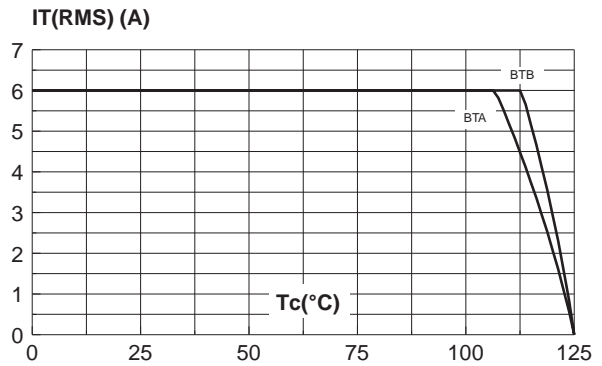

Fig. 4: On-state characteristics (maximum values).

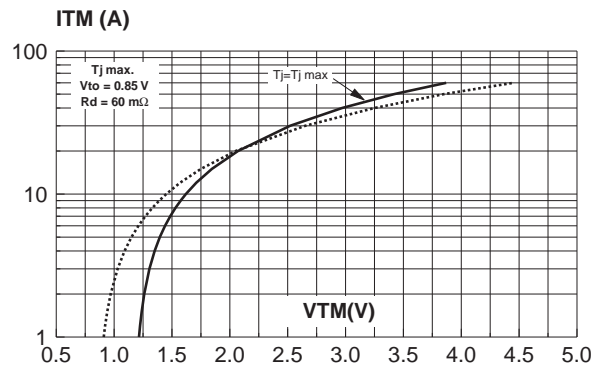

Fig. 6: Non-repetitive surge peak on-state current for a sinusoidal pulse with width $t_p < 10\text{ms}$, and corresponding value of I^2t .

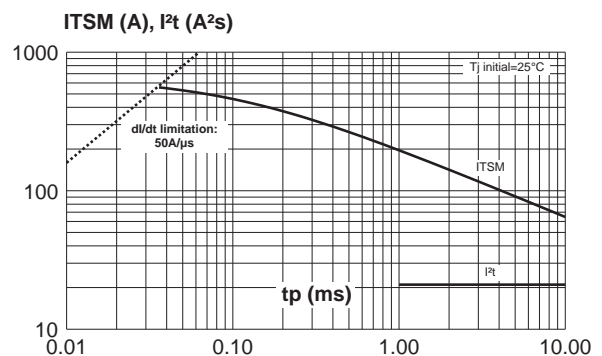

Fig. 7: Relative variation of gate trigger current, holding current and latching current versus junction temperature (typical values).

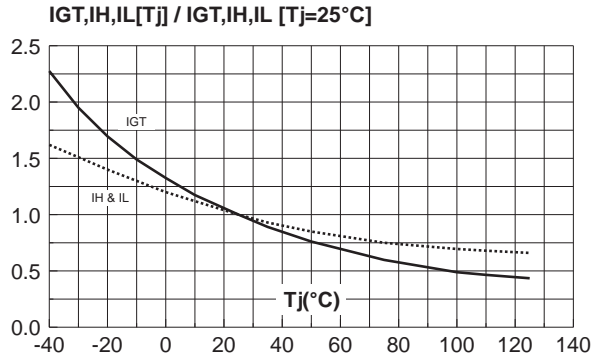

Fig. 8-2: Relative variation of critical rate of decrease of main current versus (dV/dt)_c (typical values). Standard Types

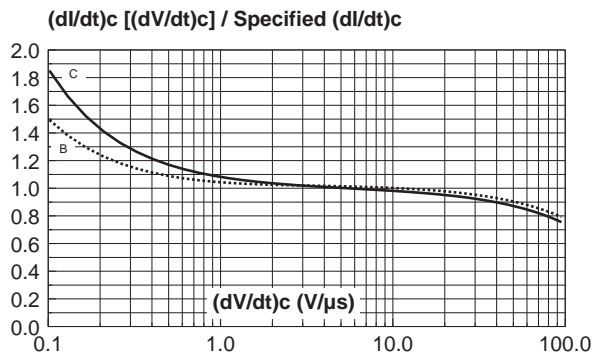

Fig. 8-1: Relative variation of critical rate of decrease of main current versus (dV/dt)_c (typical values). Snubberless & Logic Level Types

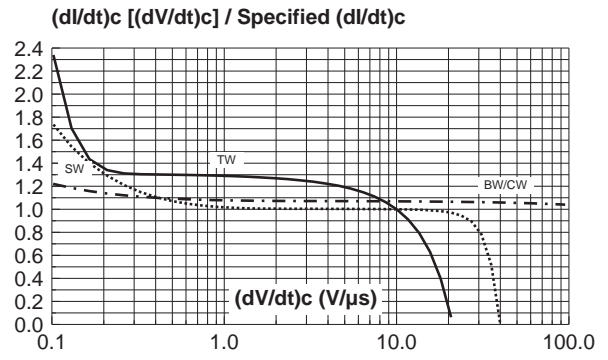

Fig. 9: Relative variation of critical rate of decrease of main current versus junction temperature.

