

## DETAILS

<b>Product Number</b>	CA10715_BOOM-S
<b>Family</b>	Boom
<b>Type</b>	RefAssy
<b>Color</b>	metal
<b>Diameter</b>	22,2 mm
<b>Height</b>	14,34 mm
<b>Style</b>	hexag
<b>Optic Material</b>	
<b>Holder Material</b>	
<b>Fastening</b>	glue, tape
<b>Status</b>	production ready
<b>ROHS Comliant</b>	Yes
<b>Date Updated</b>	8/02/2017

## OPTICAL PROPERTIES

LED	Viewing	Light	Effi-		Connector
	Angle	Beam	ciency	cd/lm	
MHD-E/G	32 deg	Spot	87 %	1.400	-
MHB-A/B	23 deg	Spot	87 %	2.240	-
NFMW48xA	25 deg	Spot	86 %	2.100	-
Duris S10	35 deg	Spot	82 %	1.600	-
Duris P10	sim: 25	Spot	sim: 86 %	sim: 2.000	-
P7	17 deg	Spot	-	3.080	-



Relative intensity of CA10715\_BOOM-S\_(MH-B)

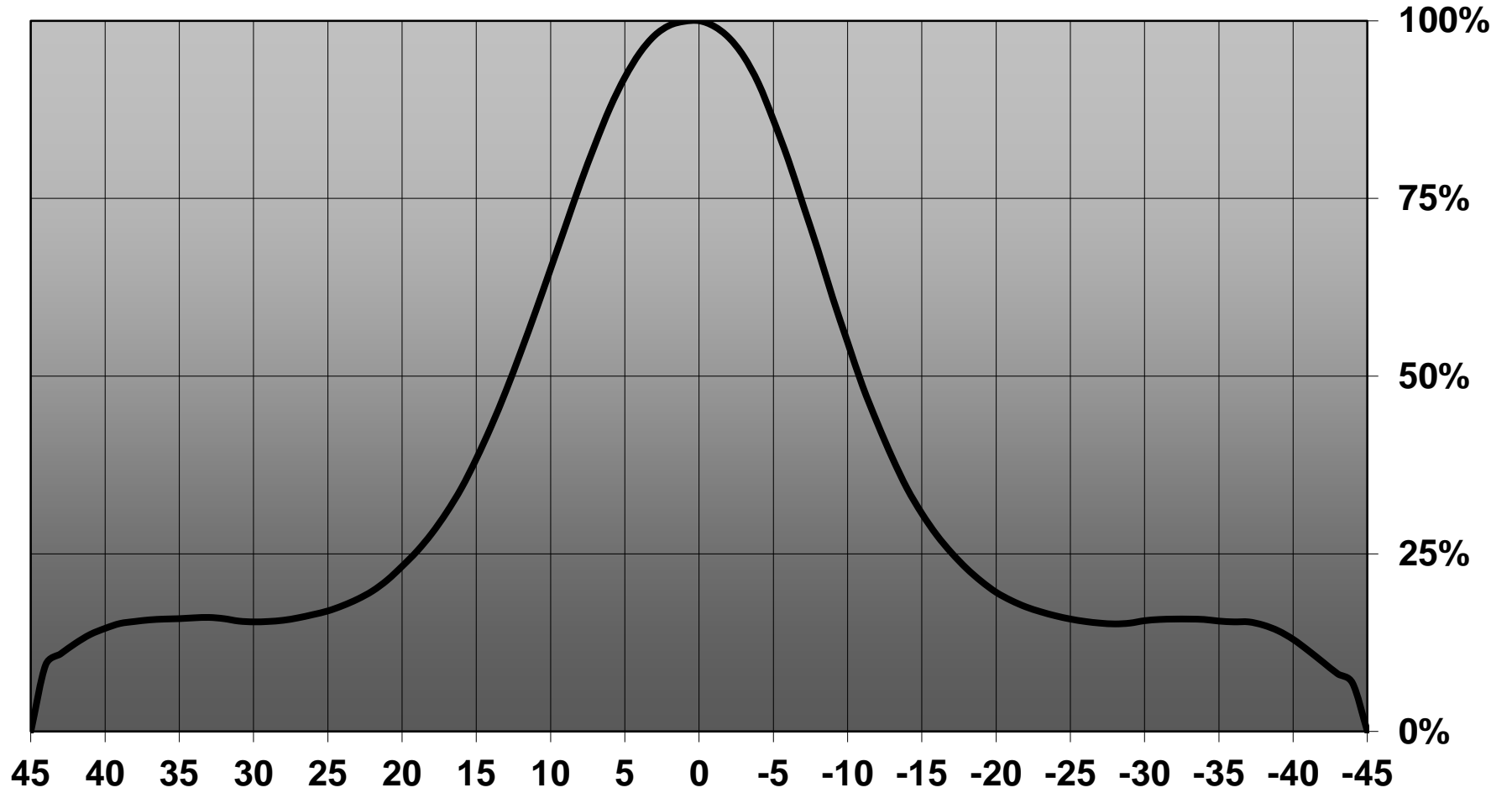

Relative intensity of CA10715\_BOOM-S\_(Duris\_S10)

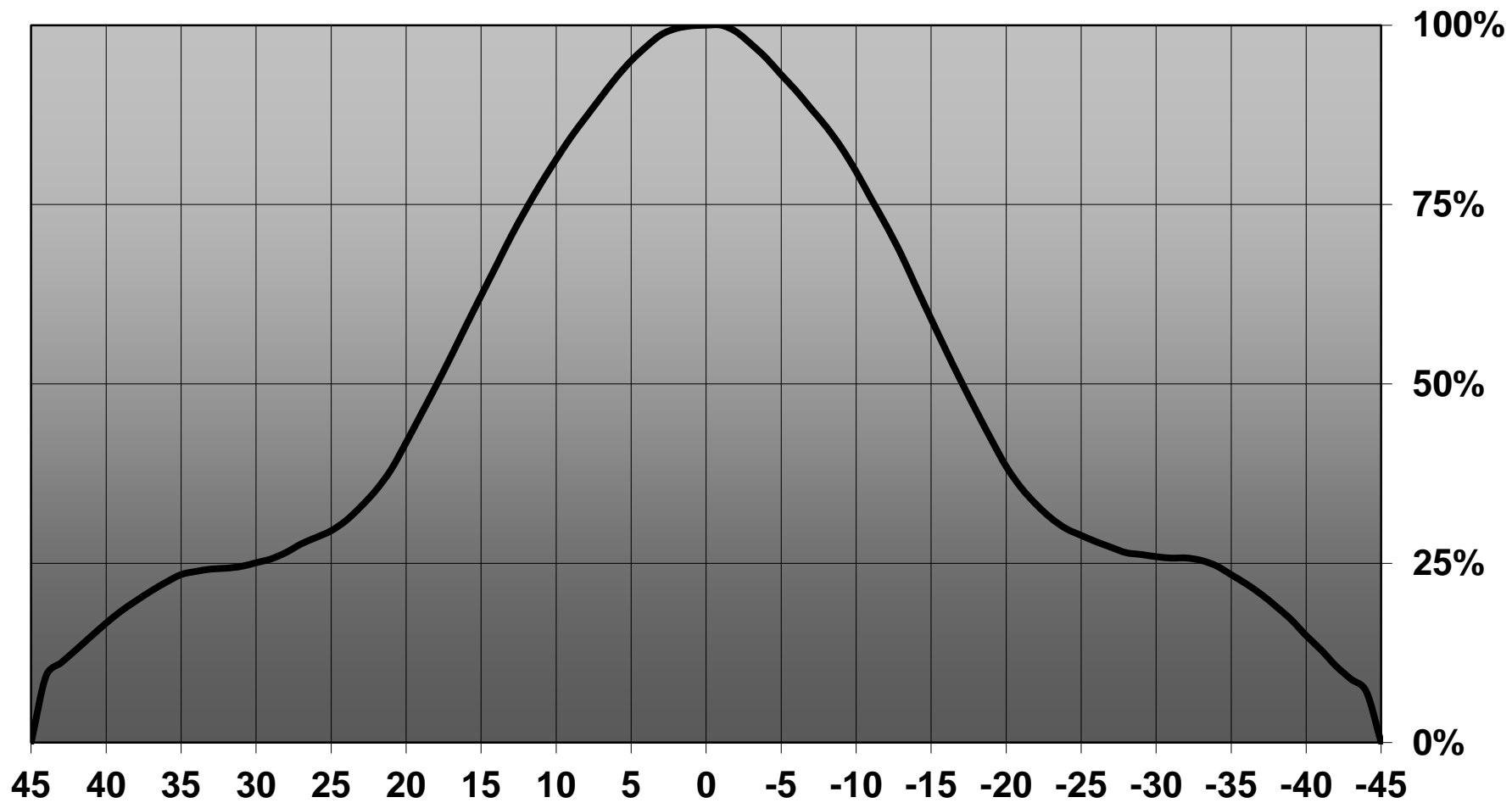

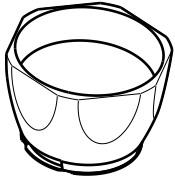

Isometric view  
Scale: 1:1

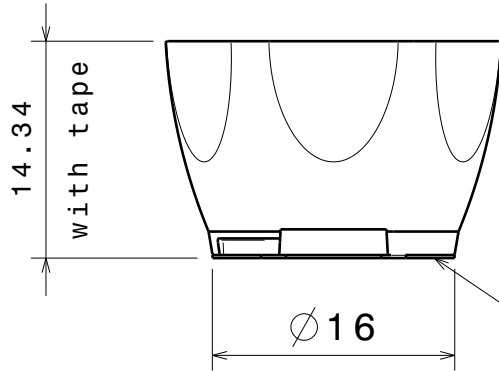

Front view  
Scale: 2:1

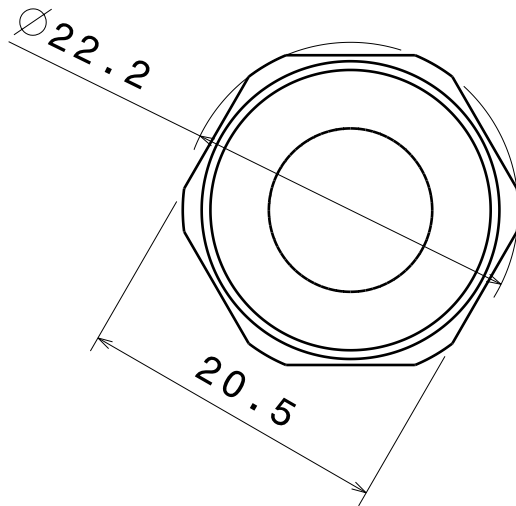

Top view  
Scale: 2:1

Part no.s:  
Spot CA10715  
Medium CA10930  
Wide CA10931

INDEX	PART NO	DESCRIPTION	MATERIAL	COLOUR
1	-	Boom-reflector	PC	metal

Tolerances if not otherwise shown  
According to DIN ISO 2768-1  
Linear measures:  
Up to 30mm class M, otherwise class C.  
According to DIN ISO 2768-2  
Form and position: class L

**LEDiL**

Ledil Oy  
Salorankatu 10  
FIN 24240 SALO  
Finland

THIRD ANGLE PROJECTION:

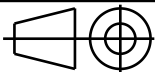

DRAWING TITLE

Boom reflector

This drawing is the property  
of LEDiL Oy. It may not be  
reproduced, copied or  
communicated without a written  
agreement with LEDiL Oy.

SIZE PART NUMBER

A4 CA10715, CA10930, CA10931

SCALE 2:1 WEIGHT 1,25 g SHEET 1/1

Luminaire: Ledil CA10715\_BOOM-S\_(MHD-G)  
Lamps: 1 x Cree MHD-G\_530.44lm@100mA\_P=3.0W\_I=0.100A

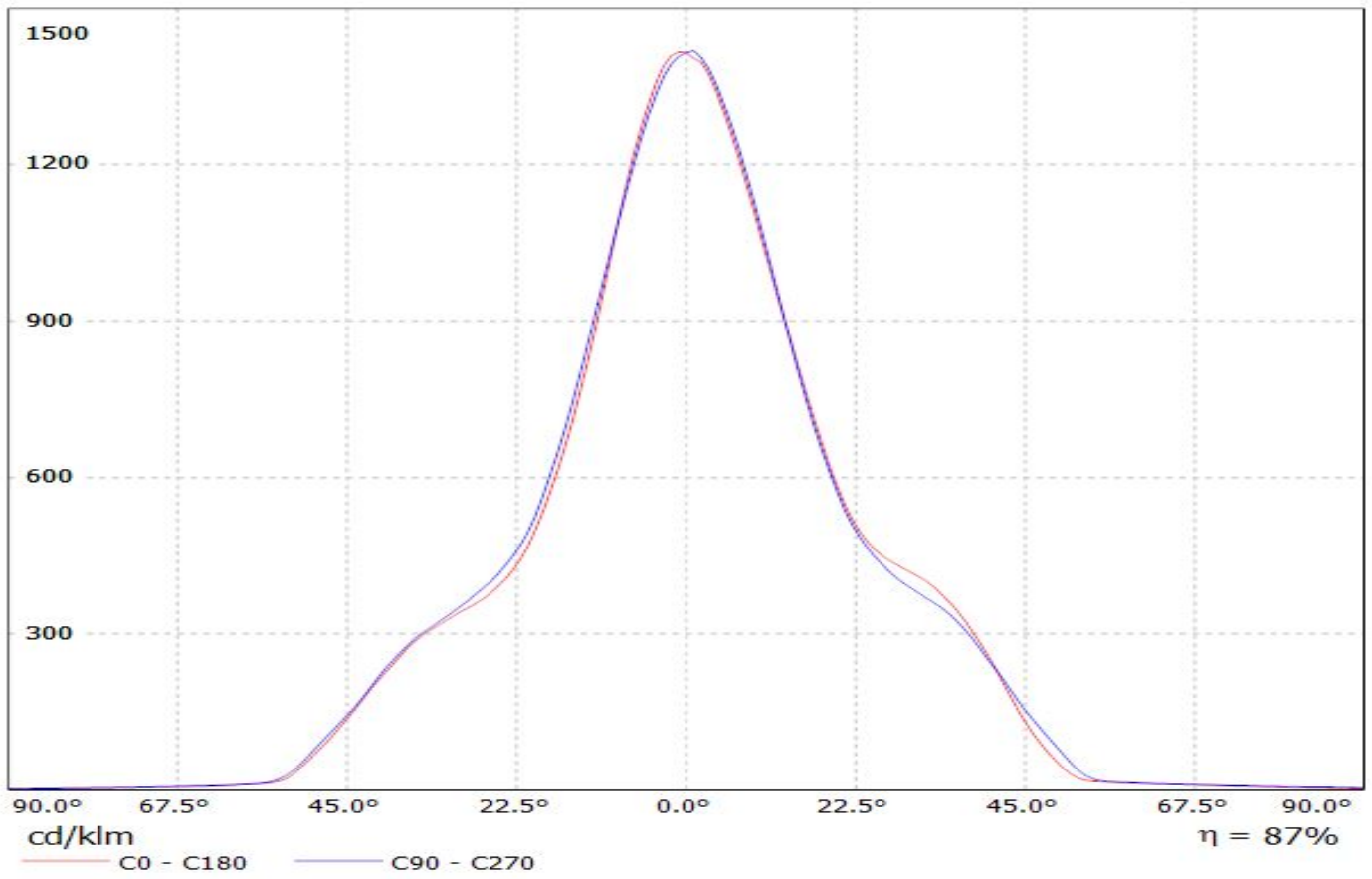

Luminaire: LEDiL Oy CA10715\_BOOM-S\_(NFMX48xAR\_14chip)

Lamps: 1 x Nichia\_NFMX48xAR\_14chip\_(NFMW488AR)\_561.275lm@100mA\_P=4.11057W\_I=0.100A

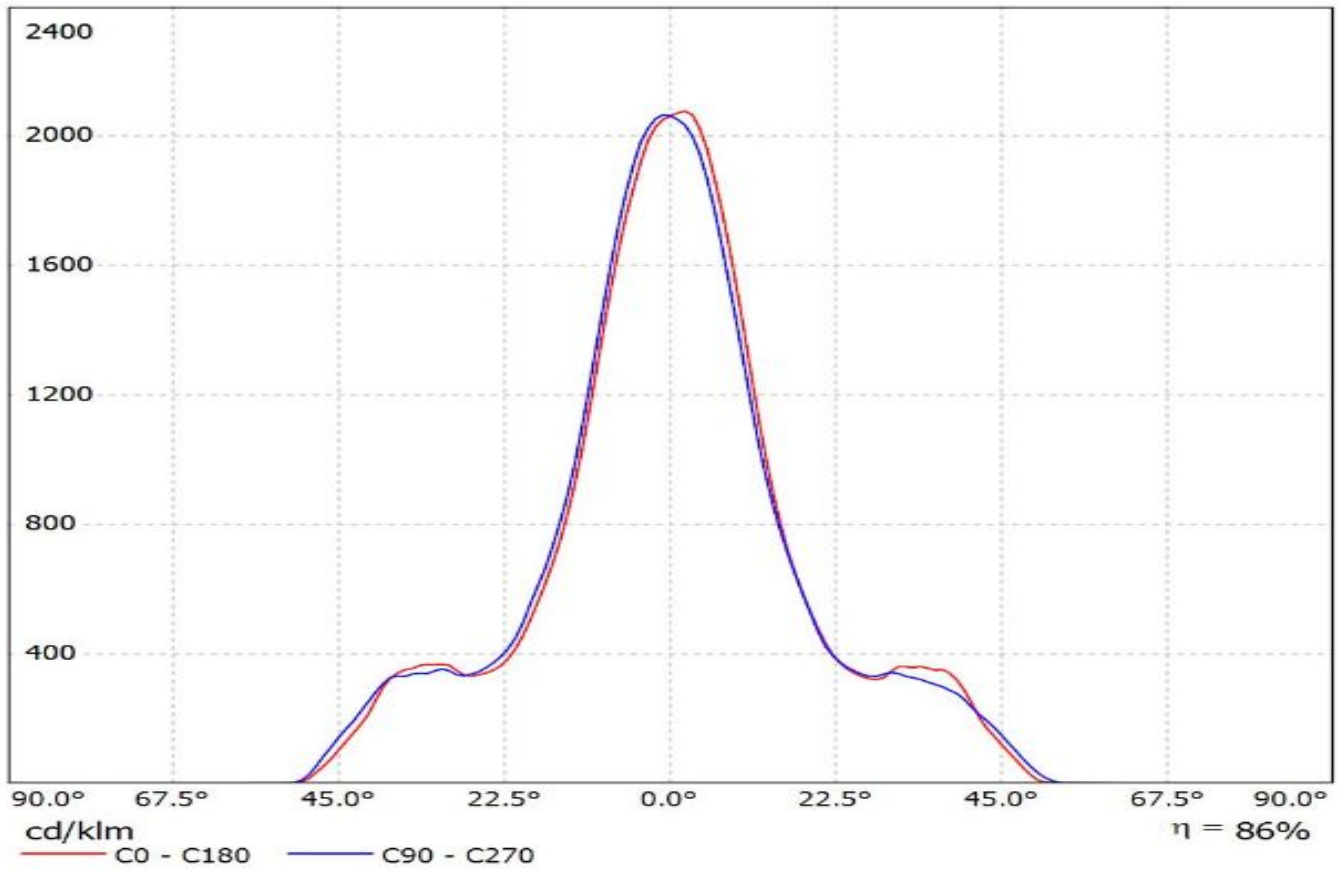

Luminaire: Ledil CA10715\_BOOM-S\_(MHD-G)

Lamps: 1 x Cree MHD-G\_530.44lm@100mA\_P=3.0W\_I=0.100A

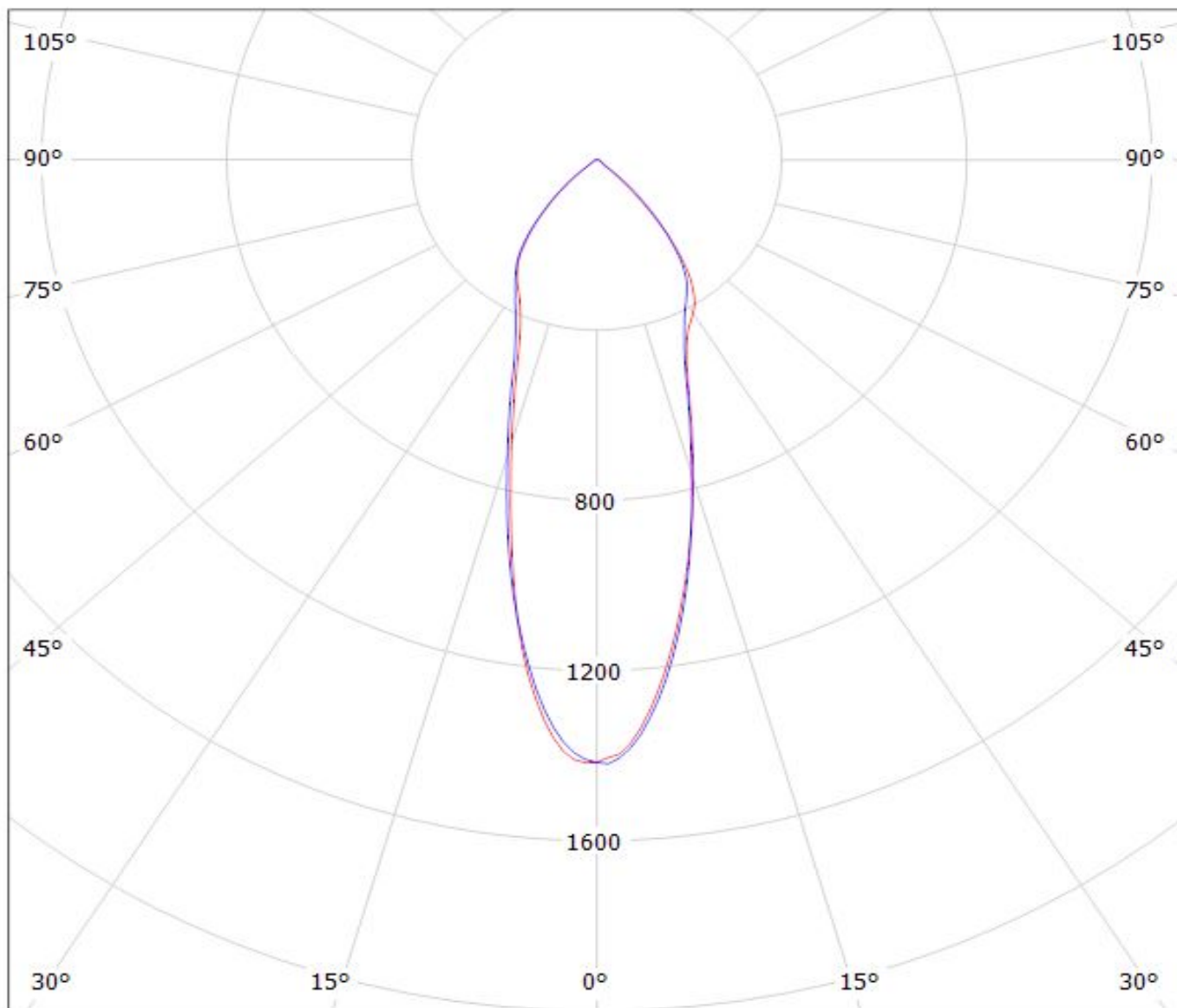

cd/klm

— C0 - C180

— C90 - C270

$\eta = 87\%$

Luminaire: LEDiL Oy CA10715\_BOOM-S\_(NFMX48xAR\_14chip)

Lamps: 1 x Nichia\_NFMX48xAR\_14chip\_(NFMW488AR)\_561.275lm@100mA\_P=4.11057W\_I=0.100A

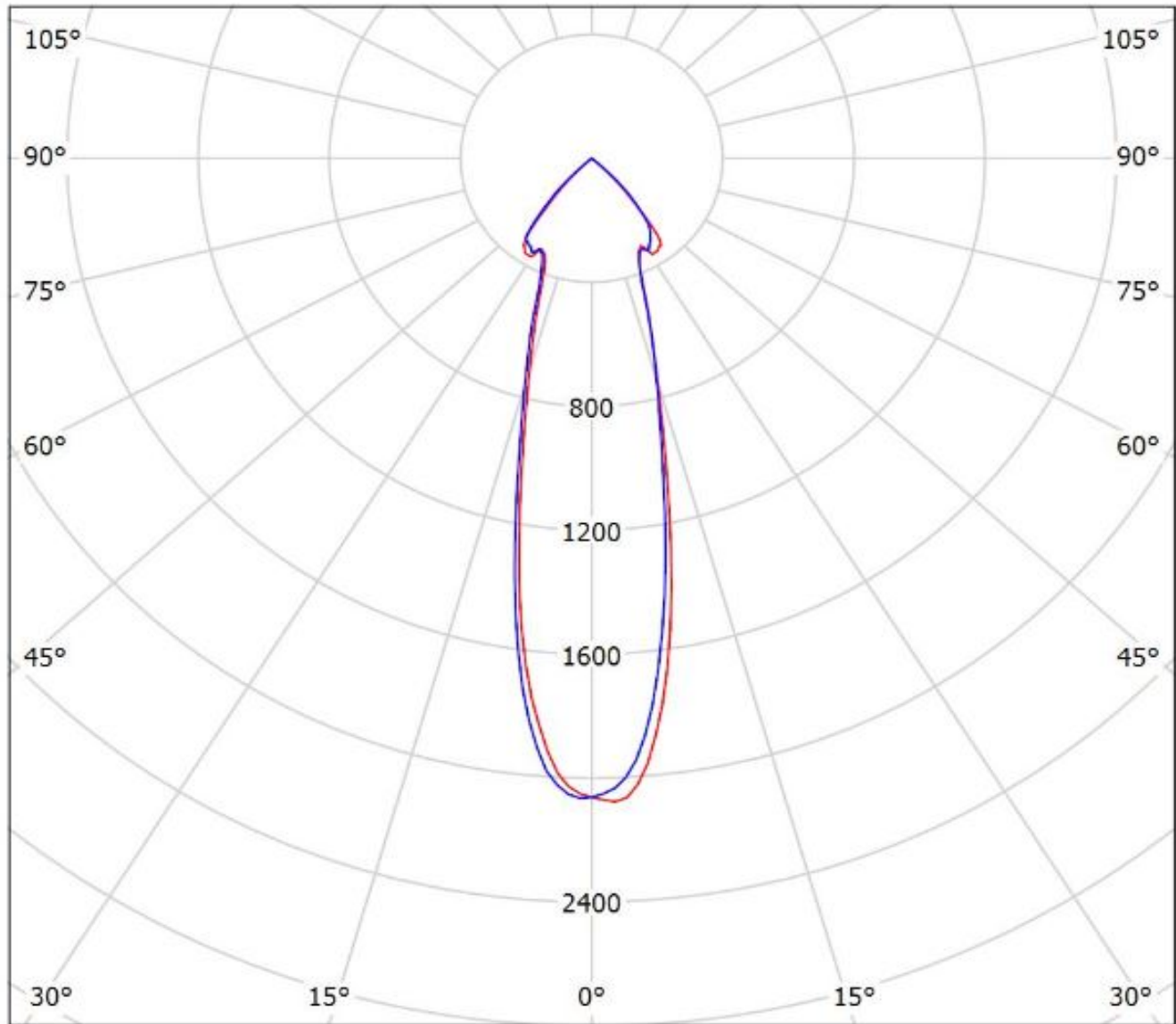

cd/klm

— C0 - C180

— C90 - C270

$\eta = 86\%$



**NOTE: The typical divergence will be changed by different color, chip size and chip position tolerance. The typical total divergence is the full angle measured where the luminous intensity is half of the peak value.**