



2SC5231A

RF Transistor 10V, 70mA, $f_T=7\text{GHz}$, NPN Single SMCP

ON Semiconductor®

<http://onsemi.com>

Features

- Low-noise : $NF=1.0\text{dB}$ typ ($f=1\text{GHz}$)
- High gain : $|S_{21e}|^2=12\text{dB}$ typ ($f=1\text{GHz}$)
- High cut-off frequency : $f_T=7\text{GHz}$ typ
- Ultrasmall-sized package permitting applied sets to be made small and slim

Specifications

Absolute Maximum Ratings at $T_a=25^\circ\text{C}$

Parameter	Symbol	Conditions	Ratings	Unit
Collector-to-Base Voltage	V_{CBO}		20	V
Collector-to-Emitter Voltage	V_{CEO}		10	V
Emitter-to-Base Voltage	V_{EBO}		2	V
Collector Current	I_C		70	mA
Collector Dissipation	P_C		100	mW
Junction Temperature	T_j		150	$^\circ\text{C}$
Storage Temperature	T_{stg}		-55 to +150	$^\circ\text{C}$

Stresses exceeding Maximum Ratings may damage the device. Maximum Ratings are stress ratings only. Functional operation above the Recommended Operating Conditions is not implied. Extended exposure to stresses above the Recommended Operating Conditions may affect device reliability.

Package Dimensions

unit : mm (typ)
7027A-002

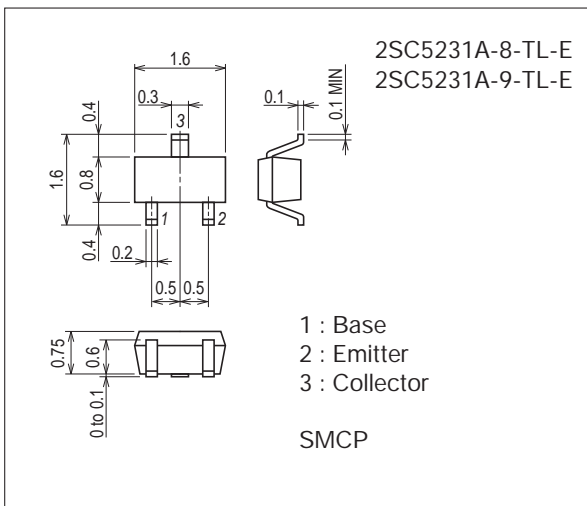

Product & Package Information

- Package : SMCP
- JEITA, JEDEC : SC-75, SOT-416
- Minimum Packing Quantity : 3,000 pcs./reel

Packing Type: TL

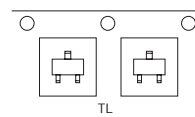

Marking

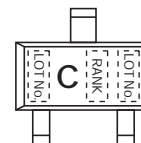

Electrical Connection

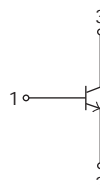

2SC5231A

Electrical Characteristics at Ta=25°C

Parameter	Symbol	Conditions	Ratings			Unit
			min	typ	max	
Collector Cutoff Current	I_{CBO}	$V_{CB}=10V, I_E=0A$			1.0	μA
Emitter Cutoff Current	I_{EBO}	$V_{EB}=1V, I_C=0A$			10	μA
DC Current Gain	h_{FE}	$V_{CE}=5V, I_C=20mA$	60*		270*	
Gain-Bandwidth Product	f_T	$V_{CE}=5V, I_C=20mA$	5	7		GHz
Output Capacitance	C_{ob}	$V_{CB}=10V, f=1MHz$		0.7	1.2	pF
Reverse Transfer Capacitance	C_{re}				0.45	
Forward Transfer Gain	$ S_{21e} ^2_1$	$V_{CE}=5V, I_C=20mA, f=1GHz$	9	12		dB
	$ S_{21e} ^2_2$	$V_{CE}=2V, I_C=3mA, f=1GHz$		8.5		dB
Noise Figure	NF	$V_{CE}=5V, I_C=7mA, f=1GHz$		1.0	1.8	dB

* : The 2SC5231A is classified by 20mA h_{FE} as follows :

Rank	7	8	9
h_{FE}	60 to 120	90 to 180	135 to 270

Ordering Information

Device	Package	Shipping	memo
2SC5231A-8-TL-E	SMCP	3,000pcs./reel	Pb Free
2SC5231A-9-TL-E	SMCP	3,000pcs./reel	

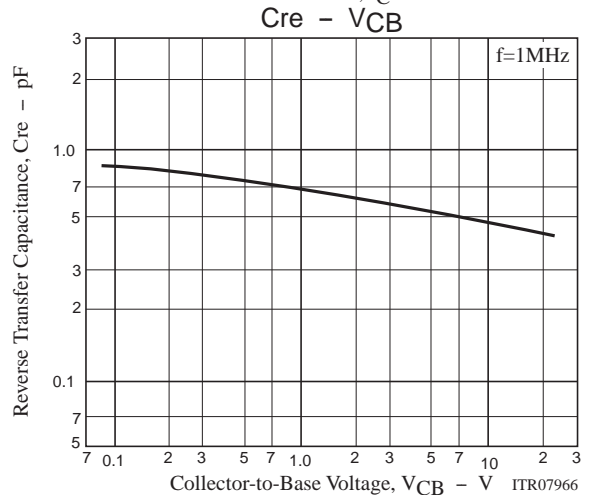
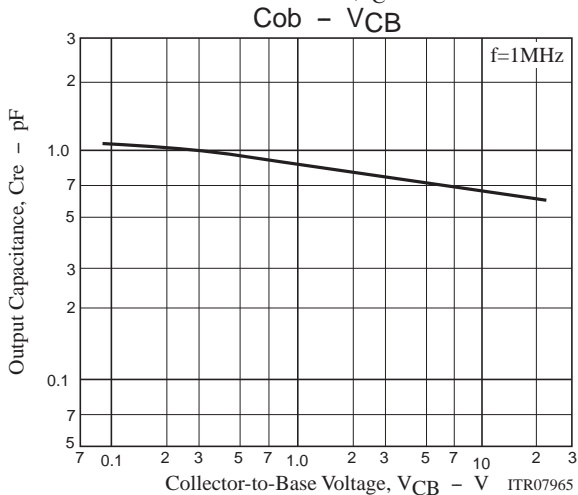
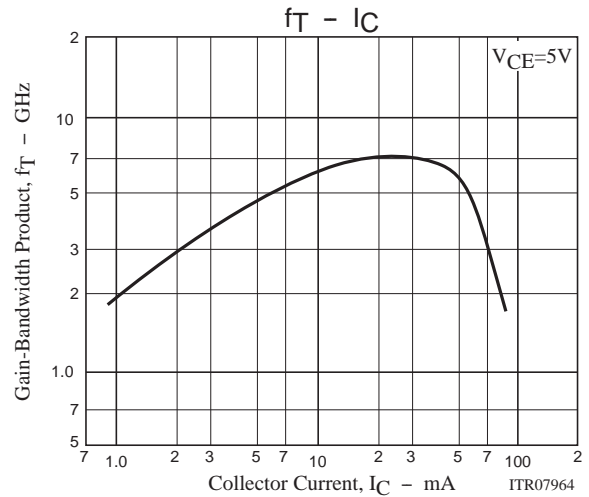
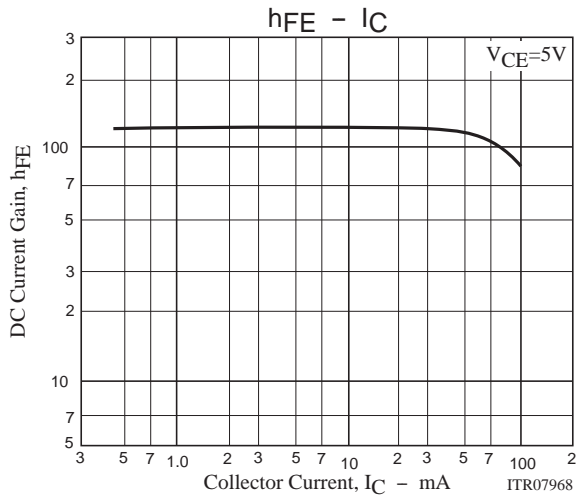

2SC5231A

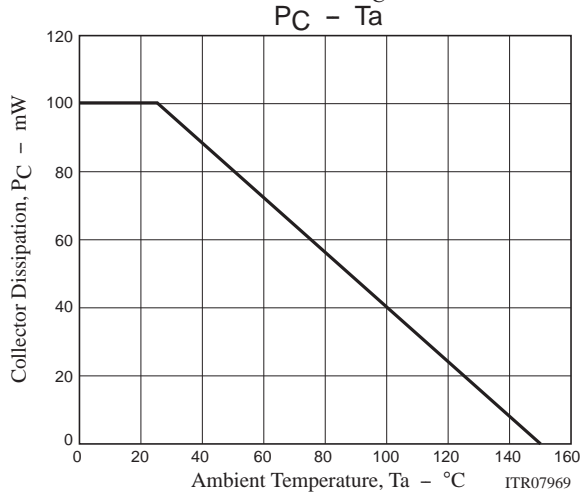
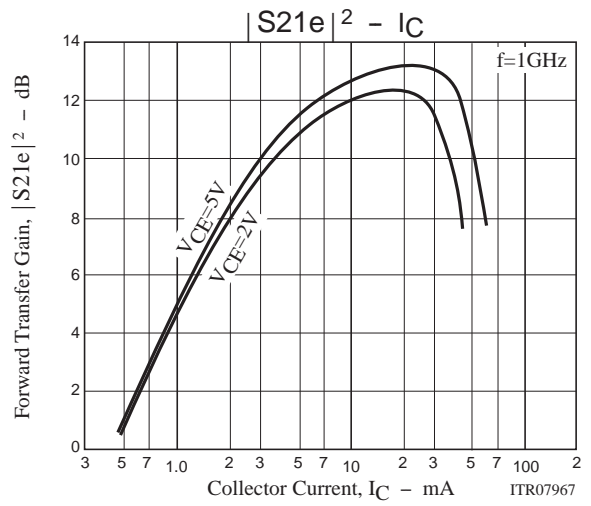
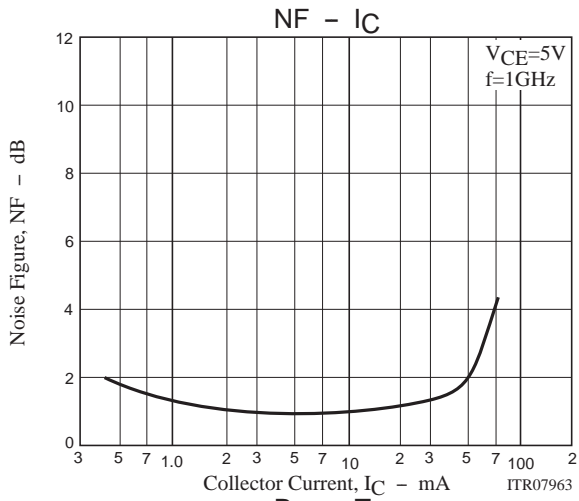

2SC5231A

S11e

f=100MHz, f=200MHz to 2000MHz(200MHz Step)

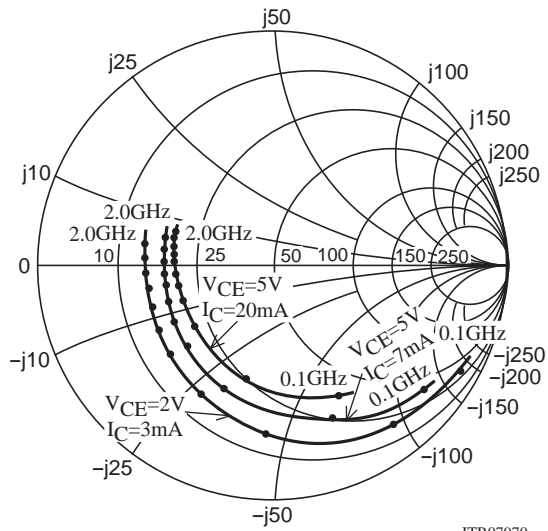

ITR07970

S21e

f=100MHz, f=200MHz to 2000MHz(200MHz Step)

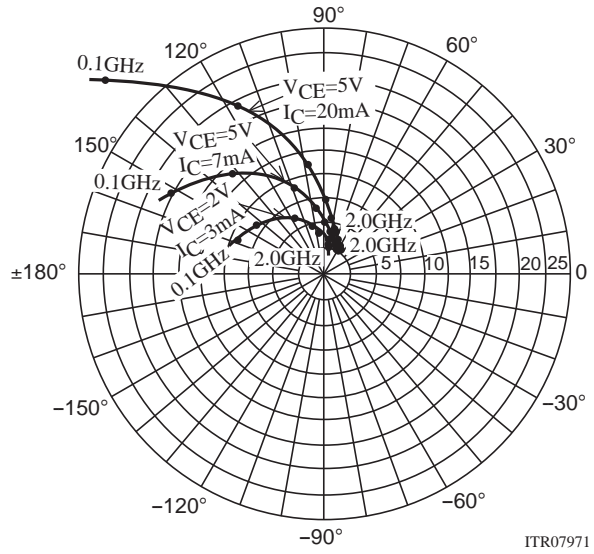

ITR07971

S12e

f=100MHz, f=200MHz to 2000MHz(200MHz Step)

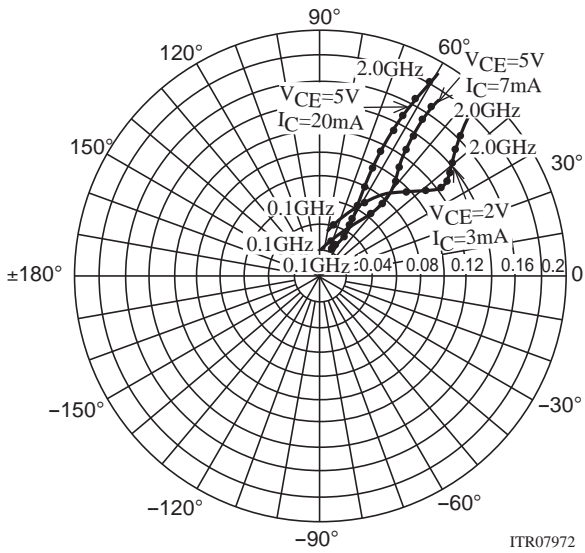

ITR07972

S22e

f=100MHz, f=200MHz to 2000MHz(200MHz Step)

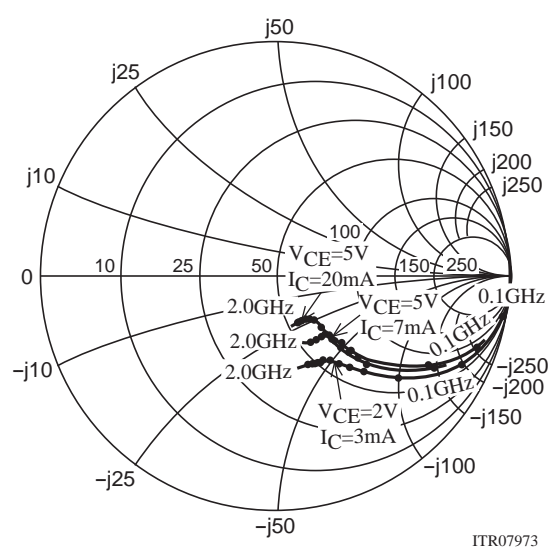

ITR07973

2SC5231A

S Parameters (Common emitter)

$V_{CE}=5V, I_C=7mA, Z_O=50\Omega$

Freq(MHz)	S11	$\angle S11$	S21	$\angle S21$	S12	$\angle S12$	S22	$\angle S22$
100	0.786	-40.7	17.507	151.3	0.028	70.1	0.898	-20.4
200	0.677	-72.4	13.998	131.4	0.046	58.0	0.739	-33.4
400	0.546	-112.7	9.061	108.6	0.064	49.6	0.525	-43.7
600	0.492	-135.2	6.442	96.1	0.076	49.3	0.423	-46.7
800	0.473	-150.0	5.005	87.3	0.087	50.8	0.374	-44.4
1000	0.465	-160.0	4.073	80.4	0.099	52.6	0.346	-49.7
1200	0.457	-169.5	3.449	74.0	0.111	54.0	0.332	-51.6
1400	0.451	-176.2	2.989	68.6	0.124	55.2	0.321	-54.1
1600	0.449	177.8	2.658	63.8	0.138	56.6	0.319	-56.2
1800	0.454	172.5	2.378	58.4	0.151	56.7	0.313	-60.0
2000	0.460	167.1	2.154	54.0	0.166	56.7	0.311	-63.2

$V_{CE}=5V, I_C=20mA, Z_O=50\Omega$

Freq(MHz)	S11	$\angle S11$	S21	$\angle S21$	S12	$\angle S12$	S22	$\angle S22$
100	0.601	-65.8	28.967	137.1	0.023	64.1	0.757	-32.9
200	0.497	-103.7	19.309	116.6	0.035	57.0	0.534	-50.3
400	0.435	-139.6	10.891	98.6	0.050	58.7	0.345	-50.3
600	0.419	-156.6	7.461	89.3	0.065	61.3	0.280	-50.7
800	0.414	-166.6	5.695	82.5	0.081	63.1	0.251	-51.3
1000	0.413	-174.0	4.613	77.0	0.098	63.8	0.235	-52.9
1200	0.413	178.6	3.870	71.8	0.114	63.9	0.226	-55.1
1400	0.411	173.8	3.345	66.9	0.131	63.6	0.221	-57.7
1600	0.413	169.6	2.960	62.7	0.148	63.2	0.220	-60.2
1800	0.416	165.1	2.655	58.0	0.165	61.8	0.219	-64.8
2000	0.422	160.3	2.406	54.0	0.182	60.6	0.218	-68.3

$V_{CE}=2V, I_C=3mA, Z_O=50\Omega$

Freq(MHz)	S11	$\angle S11$	S21	$\angle S21$	S12	$\angle S12$	S22	$\angle S22$
100	0.888	-30.2	9.280	158.6	0.038	73.6	0.949	-15.1
200	0.815	-56.4	8.218	141.3	0.067	60.5	0.849	-26.9
400	0.690	-96.0	6.074	116.7	0.098	45.1	0.657	-41.1
600	0.616	-120.7	4.517	101.4	0.112	38.4	0.539	-47.6
800	0.584	-138.0	3.610	90.4	0.120	35.8	0.475	-51.2
1000	0.566	-150.7	2.995	81.9	0.125	35.7	0.434	-54.5
1200	0.555	-161.2	2.540	74.2	0.131	36.5	0.410	-57.5
1400	0.546	-169.3	2.213	67.5	0.137	38.4	0.393	-60.7
1600	0.541	-176.4	1.982	62.0	0.143	40.7	0.391	-64.0
1800	0.545	177.1	1.774	55.9	0.152	42.5	0.382	-67.8
2000	0.547	170.9	1.614	50.9	0.163	44.7	0.381	-72.1

Embossed Taping Specification

2SC5231A-8-TL-E, 2SC5231A-9-TL-E

1. Packing Format

Package Name	Carrier Tape Type	Maximum Number of devices contained (pcs)			Packing format	
		Reel	Inner box	Outer box	Inner BOX (C-1)	Outer BOX (A-7)
SMCP	SMCP	3,000	15,000	90,000	5 reels contained Dimensions:mm (external) 183×72×185	6 inner boxes contained Dimensions:mm (external) 440×195×210

Packing method

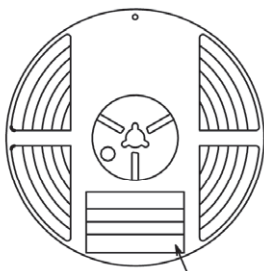

Reel label, Inner box label
(unit:mm)

Outer box label
It is a label at the time of factory shipments.
The form of a label may change in physical distribution process.

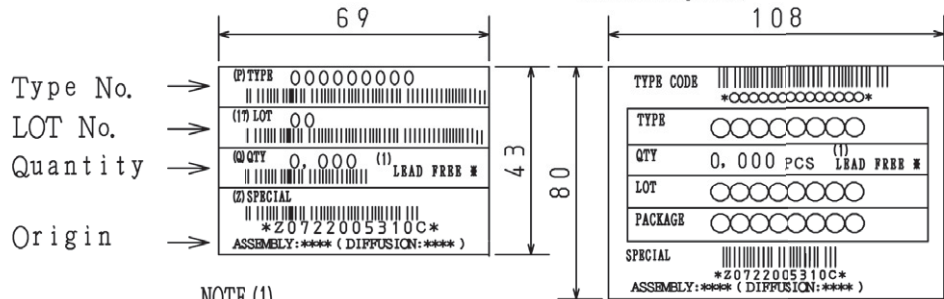

NOTE (1)

The LEAD FREE * description shows that the surface treatment of the terminal is lead free.

Label	JEITA Phase
.....	JEITA Phase 3

2. Taping configuration

2-1. Carrier tape size (unit:mm)

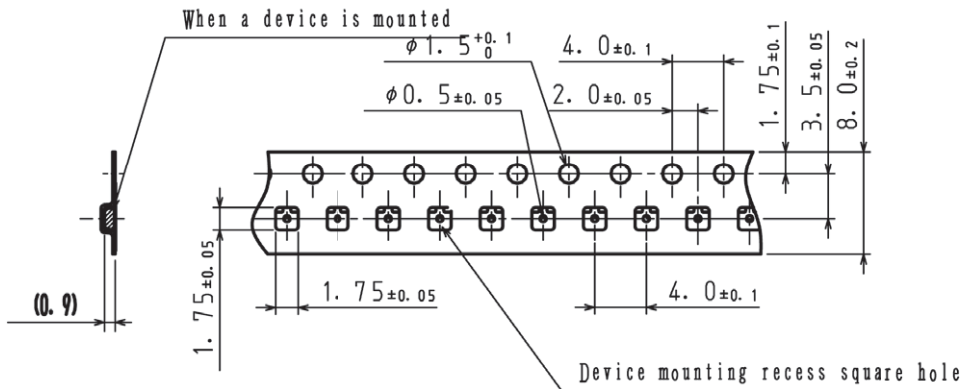

2-2. Device placement direction

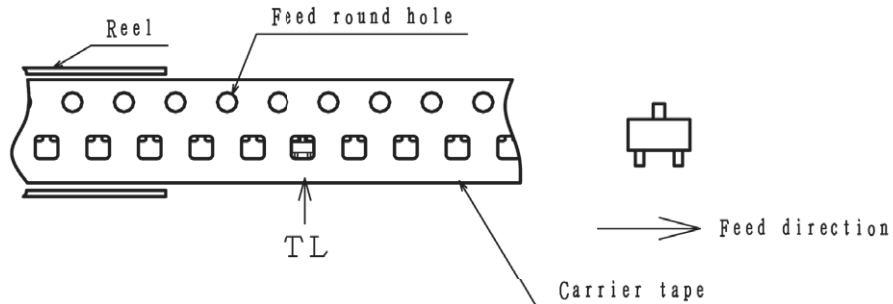

Those with one electrode terminal on the feed hole side.....TL

2SC5231A

Outline Drawing

2SC5231A-8-TL-E, 2SC5231A-9-TL-E

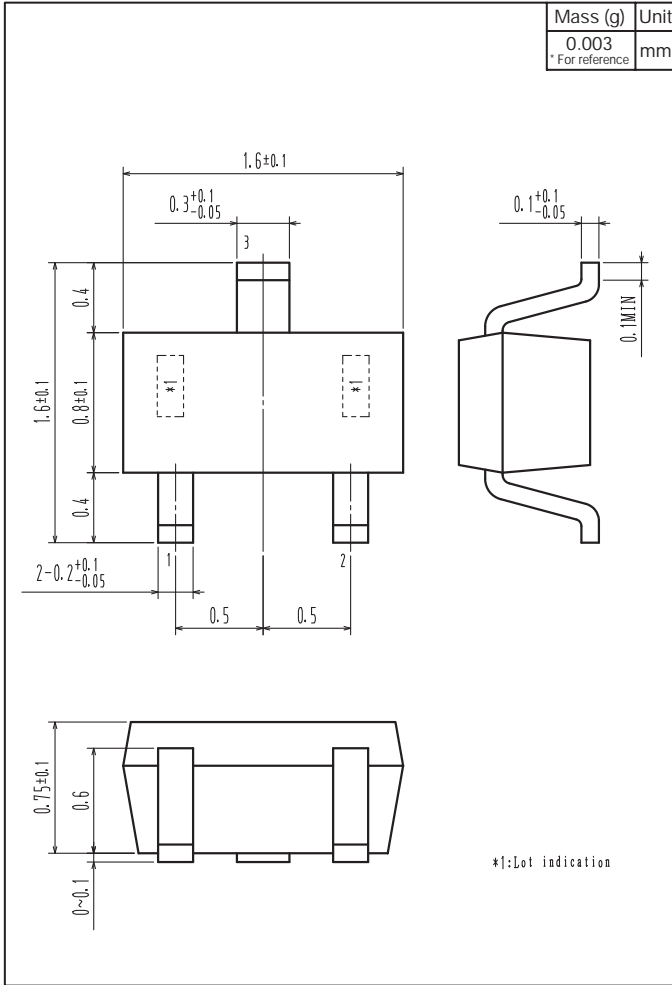

Land Pattern Example

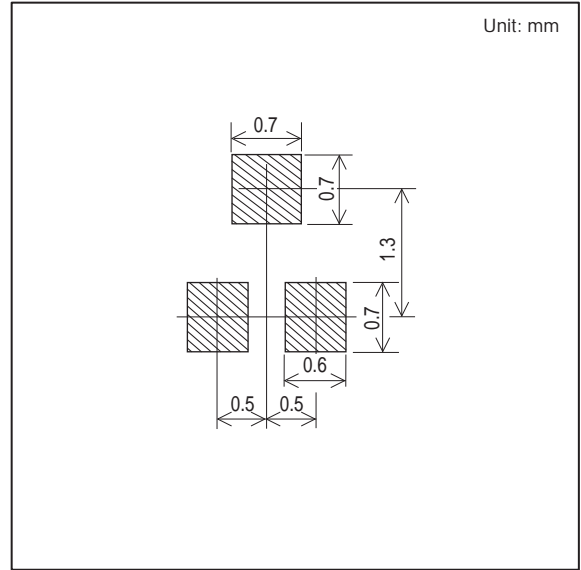

ON Semiconductor and the ON logo are registered trademarks of Semiconductor Components Industries, LLC (SCILLC). SCILLC owns the rights to a number of patents, trademarks, copyrights, trade secrets, and other intellectual property. A listing of SCILLC's product/patent coverage may be accessed at www.onsemi.com/site/pdf/Patent-Marking.pdf. SCILLC reserves the right to make changes without further notice to any products herein. SCILLC makes no warranty, representation or guarantee regarding the suitability of its products for any particular purpose, nor does SCILLC assume any liability arising out of the application or use of any product or circuit, and specifically disclaims any and all liability, including without limitation special, consequential or incidental damages. "Typical" parameters which may be provided in SCILLC data sheets and/or specifications can and do vary in different applications and actual performance may vary over time. All operating parameters, including "Typicals" must be validated for each customer application by customer's technical experts. SCILLC does not convey any license under its patent rights nor the rights of others. SCILLC products are not designed, intended, or authorized for use as components in systems intended for surgical implant into the body, or other applications intended to support or sustain life, or for any other application in which the failure of the SCILLC product could create a situation where personal injury or death may occur. Should Buyer purchase or use SCILLC products for any such unintended or unauthorized application, Buyer shall indemnify and hold SCILLC and its officers, employees, subsidiaries, affiliates, and distributors harmless against all claims, costs, damages, and expenses, and reasonable attorney fees arising out of, directly or indirectly, any claim of personal injury or death associated with such unintended or unauthorized use, even if such claim alleges that SCILLC was negligent regarding the design or manufacture of the part. SCILLC is an Equal Opportunity/Affirmative Action Employer. This literature is subject to all applicable copyright laws and is not for resale in any manner.