

TSOT26 LIGHT LOAD IMPROVED 2A SYNCH DC/DC BUCK CONVERTER

Description

The AP65201 is a 500kHz switching frequency internal compensated synchronous DC/DC buck converter. It has integrated low $R_{DS(ON)}$ high and low side MOSFETs.

The AP65201 enables continuous load current of up to 2A with efficiency as high as 97%.

The AP65201 implements an automatic custom light load efficiency improvement algorithm.

The AP65201 features current mode control operation, which enables fast transient response times and easy loop stabilization.

The AP65201 simplifies board layout and reduces space requirements with its high level of integration and minimal need for external components, making it ideal for distributed power architectures.

The AP65201 is available in a standard Green TSOT26 package and is RoHS compliant.

Pin Assignments

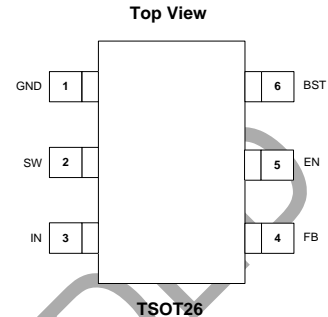

Features

- V_{IN} 4.5V to 16V
- 2A Continuous Output Current, 3A Peak
- Efficiency Up to 97%
- Automated Light Load Improvement
- V_{OUT} Adjustable From 0.8V
- 500kHz Switching Frequency
- Internal Soft-Start
- Enable Pin
- Overcurrent Protection (OCP) with Hiccup
- Thermal Protection
- **Totally Lead-Free & Fully RoHS Compliant (Notes 1 & 2)**
- **Halogen and Antimony Free. "Green" Device (Note 3)**

Applications

- Gaming Consoles
- Flat Screen TV Sets and Monitors
- Set-Top Boxes
- Distributed Power Systems
- Home Audio
- Consumer Electronics
- Network Systems
- FPGA, DSP and ASIC Supplies
- Green Electronics

Notes: 1. No purposely added lead. Fully EU Directive 2002/95/EC (RoHS) & 2011/65/EU (RoHS 2) compliant.
 2. See http://www.diodes.com/quality/lead_free.html for more information about Diodes Incorporated's definitions of Halogen- and Antimony-free, "Green" and Lead-free.
 3. Halogen- and Antimony-free "Green" products are defined as those which contain <900ppm bromine, <900ppm chlorine (<1500ppm total Br + Cl) and <1000ppm antimony compounds.

Typical Applications Circuit

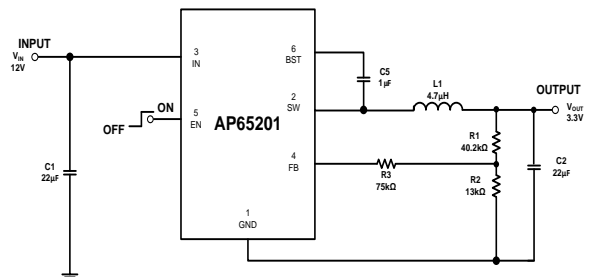
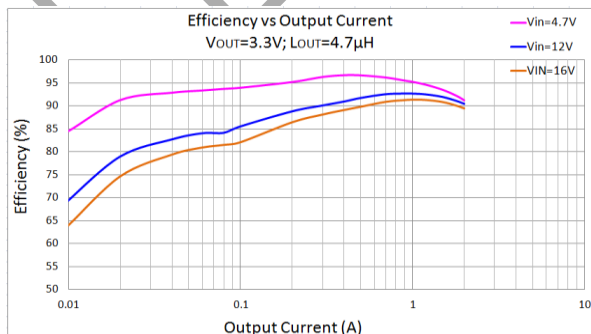
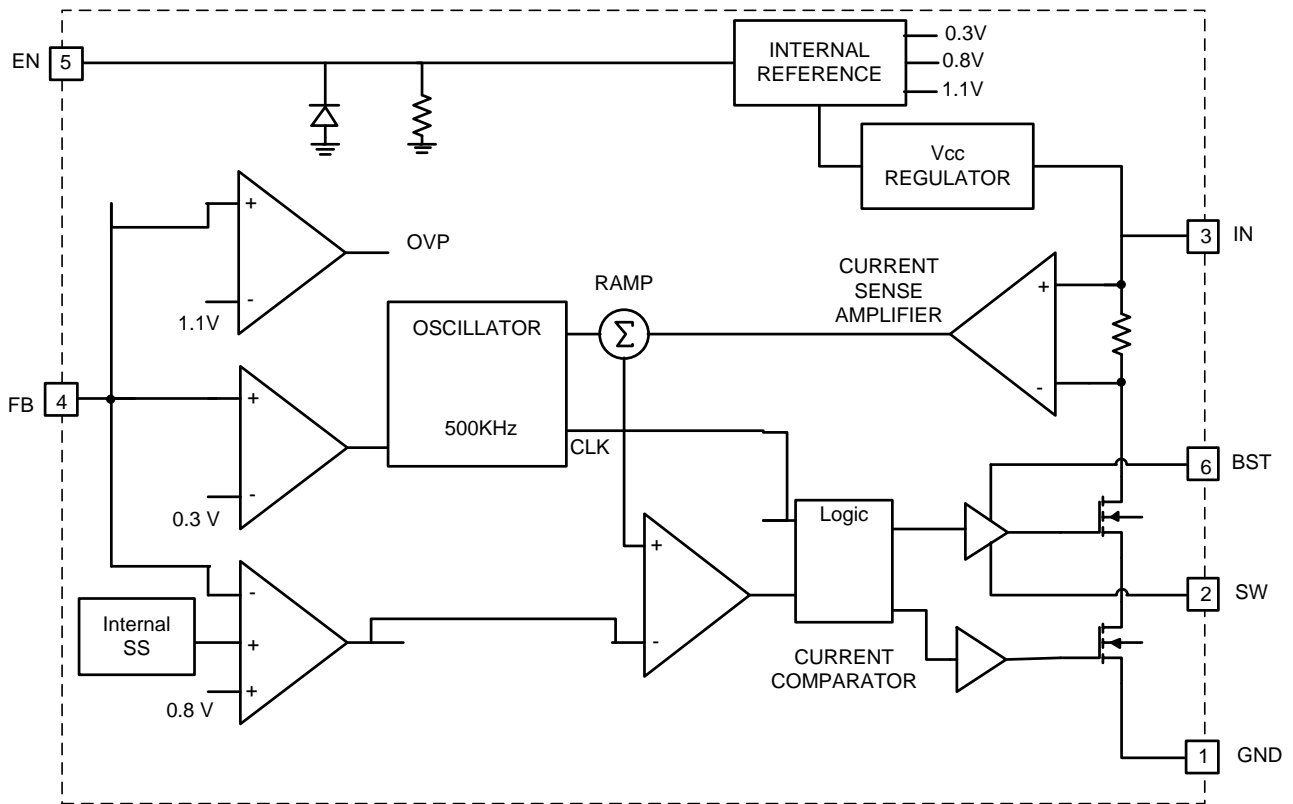

Figure 1. Typical Application Circuit

Pin Descriptions

Pin Name	Pin Number	Function
GND	1	Ground
SW	2	Power Switching Output. SW is the switching node that supplies power to the output. Connect the output LC filter from SW to the output load. Note that a capacitor is required from SW to BS to power the high-side switch.
IN	3	Power Input. IN supplies the power to the IC, as well as the step-down converter switches. Drive IN with a 4.5V to 16V power source. Bypass IN to GND with a suitably large capacitor to eliminate noise on the input to the IC. See Input Capacitor.
FB	4	Feedback Input. FB senses the output voltage and regulates it. Drive FB with a resistive voltage divider connected to it from the output voltage. The feedback threshold is 0.8V. See Setting the Output Voltage.
EN	5	Enable Input. EN is a digital input that turns the regulator on or off. Drive EN high to turn on the regulator; low to turn it off. Attach to IN with a 100kΩ pull up resistor for automatic startup.
BST	6	High-Side Gate Drive Boost Input. BS supplies the drive for the high-side N-Channel MOSFET a 0.01μF or greater capacitor from SW to BS to power the high side switch.

Functional Block Diagram



Absolute Maximum Ratings (@ $T_A = +25^{\circ}\text{C}$, unless otherwise specified.) (Note 4)

Symbol	Parameter	Rating	Unit
V_{IN}	Supply Voltage	-0.3 to 20	V
V_{SW}	Switch Node Voltage	-1.0 to $V_{IN} + 0.3$	V
V_{BS}	Bootstrap Voltage	$V_{SW} - 0.3$ to $V_{SW} + 6.0$	V
V_{FB}	Feedback Voltage	-0.3V to +6.0	V
V_{EN}	Enable/UVLO Voltage	-0.3V to +6.0	V
T_{ST}	Storage Temperature	-65 to +150	$^{\circ}\text{C}$
T_J	Junction Temperature	+160	$^{\circ}\text{C}$
T_L	Lead Temperature	+260	$^{\circ}\text{C}$
ESD Susceptibility (Note 5)			
HBM	Human Body Model	2.5	kV
CDM	Charged Device Model	1	kV

- Notes:
- Stresses greater than the 'Absolute Maximum Ratings' specified above may cause permanent damage to the device. These are stress ratings only; functional operation of the device at these or any other conditions exceeding those indicated in this specification is not implied. Device reliability may be affected by exposure to absolute maximum rating conditions for extended periods of time.
 - Semiconductor devices are ESD sensitive and may be damaged by exposure to ESD events. Suitable ESD precautions should be taken when handling and transporting these devices.

Thermal Resistance (Note 6)

Symbol	Parameter	Rating		Unit
θ_{JA}	Junction to Ambient	TSOT26	120	$^{\circ}\text{C}/\text{W}$
θ_{JC}	Junction to Case	TSOT26	30	$^{\circ}\text{C}/\text{W}$

- Note: 6. Test condition for SOT26: Device mounted on FR-4 substrate, single-layer PC board, 2oz copper, with minimum recommended pad layout.

Recommended Operating Conditions (@ $T_A = +25^{\circ}\text{C}$, unless otherwise specified.) (Note 7)

Symbol	Parameter	Min	Max	Unit
V_{IN}	Supply Voltage	4.5	16	V
T_A	Operating Ambient Temperature Range	-40	+85	$^{\circ}\text{C}$

- Note: 7. The device function is not guaranteed outside of the recommended operating conditions.

Electrical Characteristics (@T_A = +25°C, V_{IN} = 12V, unless otherwise specified.)

Symbol	Parameter	Test Condition	Min	Typ	Max	Unit
I _{SHDN}	Shutdown Supply Current	V _{EN} = 0V	—		1.0	μA
I _Q	Supply Current (Quiescent)	V _{EN} = 2.0V, V _{FB} = 0.85V	—	0.83	—	mA
R _{DS(ON)1}	High-Side Switch On-Resistance (Note 8)	—	—	160	—	mΩ
R _{DS(ON)2}	Low-Side Switch On-Resistance (Note 8)	—	—	85	—	mΩ
I _{LIMIT}	HS Current Limit (Note 8)	Minimum duty cycle	2.8	3.5	—	A
I _{SW_LKG}	High-Side Switch Leakage Current	V _{EN} = 0V, V _{SW} = 12V	—		1	μA
F _{SW}	Oscillator Frequency	V _{FB} = 0.75V	400	500	600	kHz
D _{MAX}	Maximum Duty Cycle	V _{FB} = 700mV	88	92	—	%
t _{ON}	Minimum On Time	—	—	90	—	ns
V _{FB}	Feedback Voltage	T _A = -40°C to +85°C	776	800	824	mV
V _{EN_RISING}	EN Rising Threshold	—	1.4	1.5	1.6	V
V _{EN_FALLING}	EN Falling Threshold	—	1.23	1.32	1.41	V
I _{EN}	EN Input Current	V _{EN} = 2V	—	2.85	—	μA
		V _{EN} = 0V	—	0	—	μA
INUV _{VTH}	V _{IN} Undervoltage Threshold Rising	—	3.7	4.05	4.4	V
INUV _{HYS}	V _{IN} Undervoltage Threshold Hysteresis	—	—	250	—	mV
t _{SS}	Soft-Start Period	—	—	1	—	ms
T _{SHDN}	Thermal Shutdown (Note 8)	—	—	+160	—	°C
T _{HYS}	Thermal Hysteresis (Note 8)	—	—	+20	—	°C

Note: 8. Guaranteed by design.

NOT RECOMMENDED FOR NEW DESIGN

Typical Performance Characteristics (@ $T_A = +25^\circ\text{C}$, $V_{IN} = 12\text{V}$, $V_{OUT} = 3.3\text{V}$, $L = 4.7\mu\text{H}$, unless otherwise specified.)

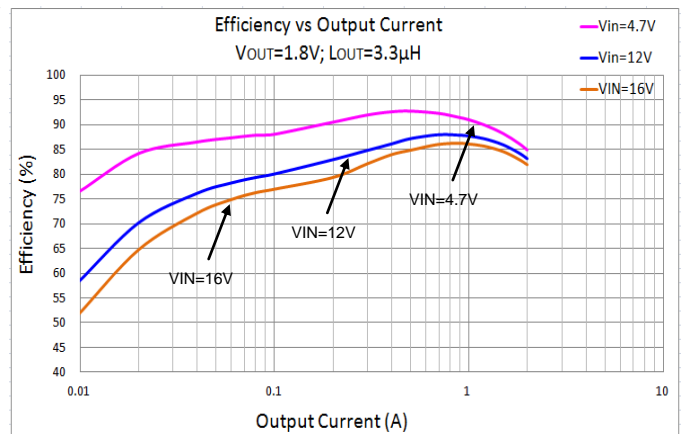
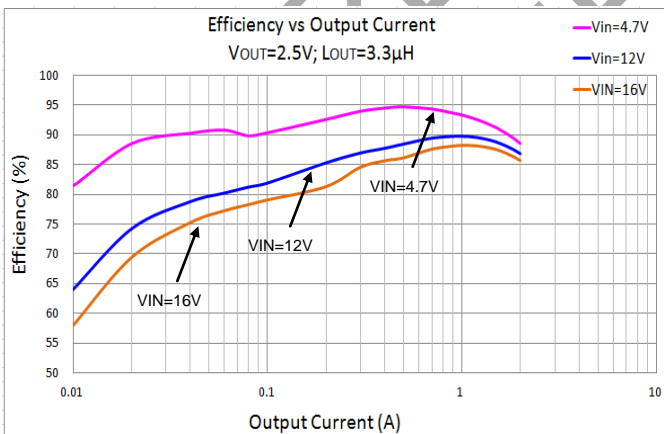
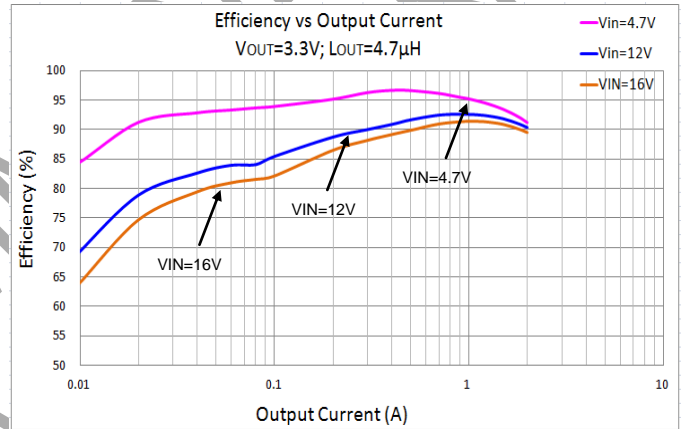
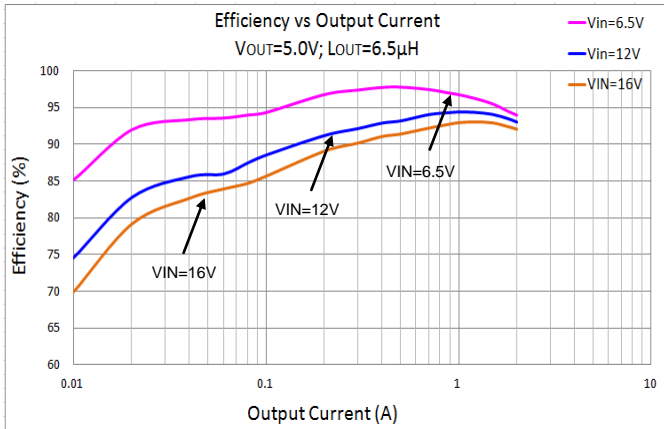
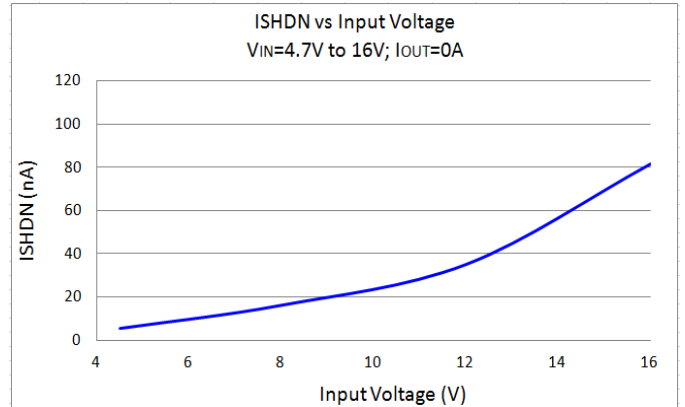
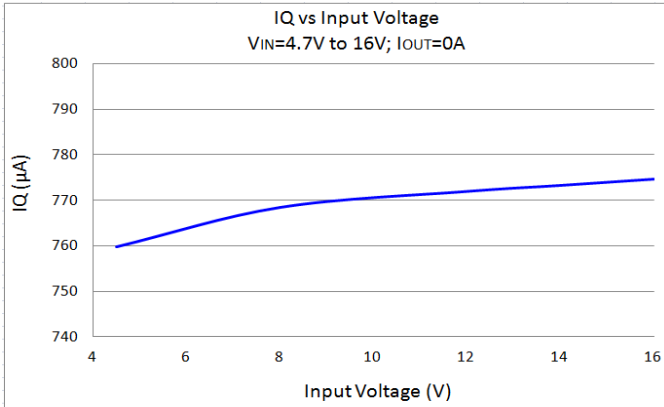

Typical Performance Characteristics (Cont.) (@ $T_A = +25^\circ\text{C}$, $V_{IN} = 12\text{V}$, $V_{OUT} = 3.3\text{V}$, $L = 4.7\mu\text{H}$, unless otherwise specified.)

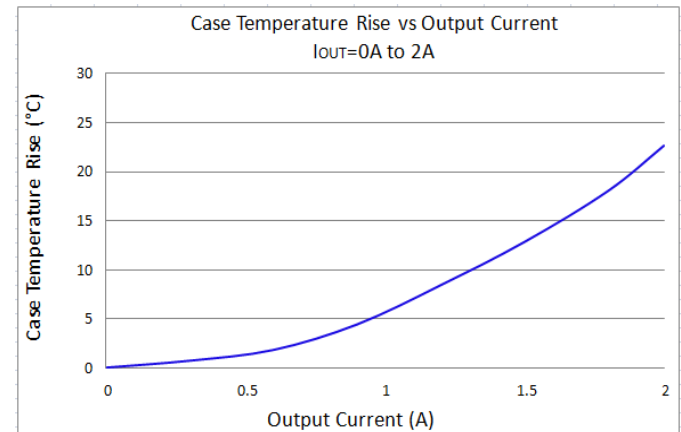
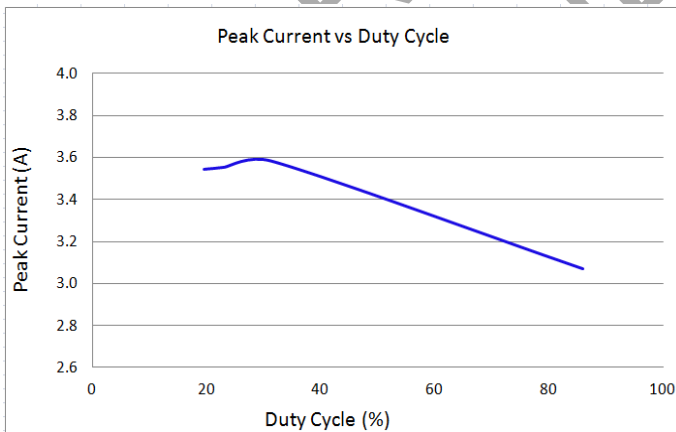
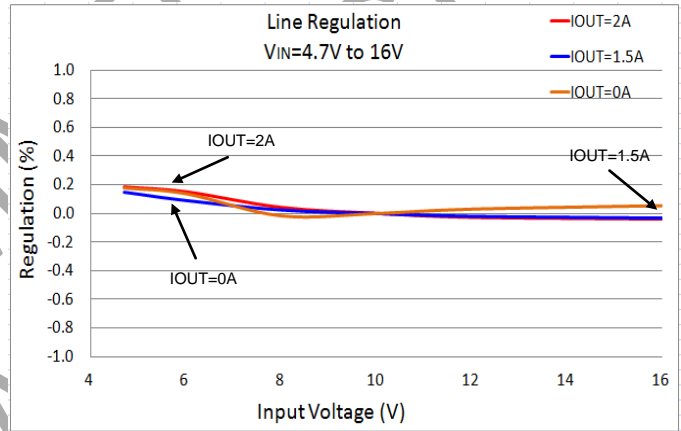
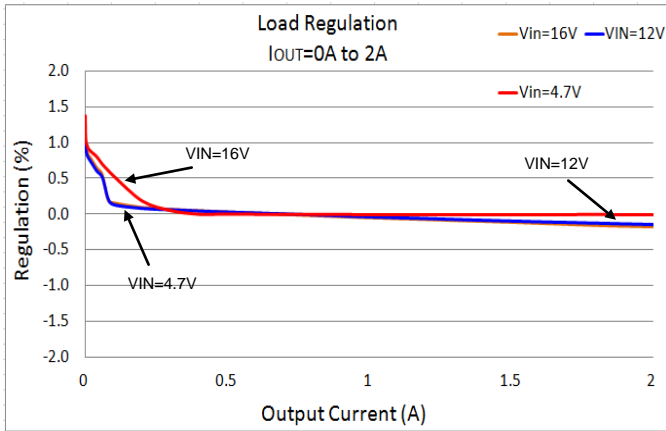
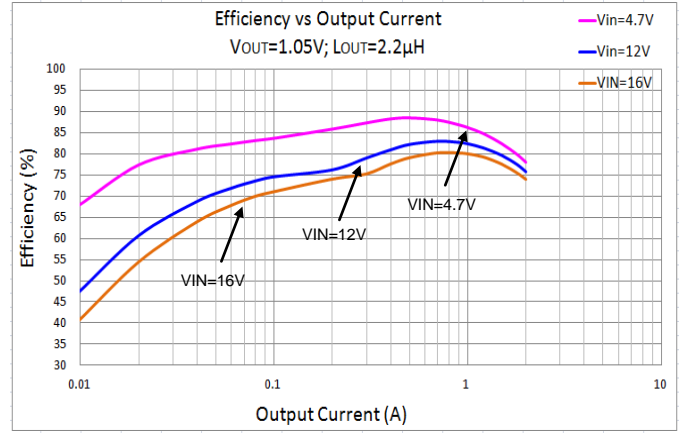
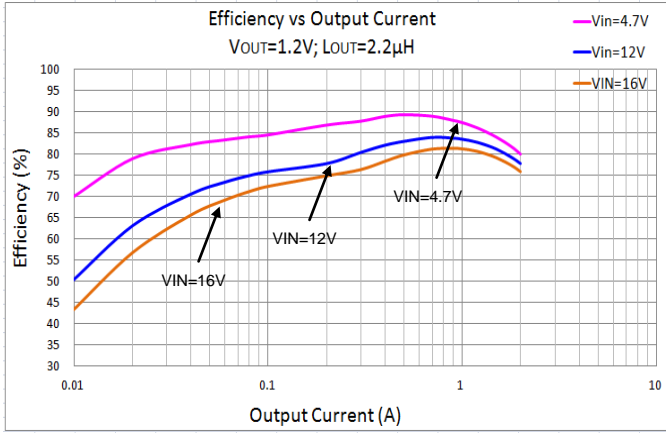

Typical Performance Characteristics (Cont.) (@ $T_A = +25^\circ\text{C}$, $V_{IN} = 12\text{V}$, $V_{OUT} = 3.3\text{V}$, $L = 4.7\mu\text{H}$, $C_1 = 22\mu\text{F}$, $C_2 = 22\mu\text{F}$, unless otherwise specified.)

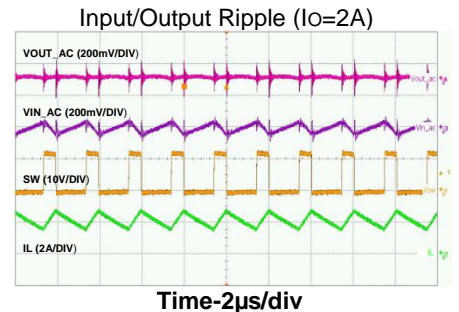
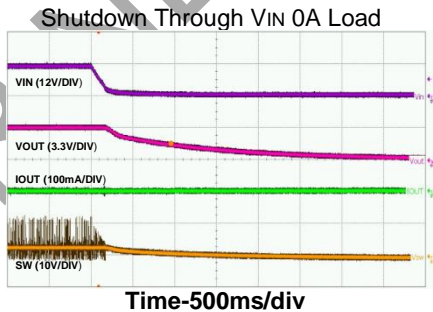
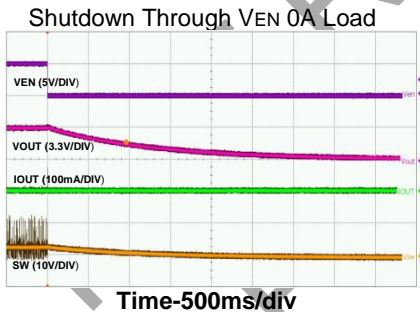
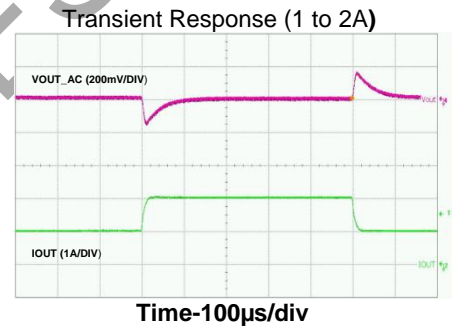
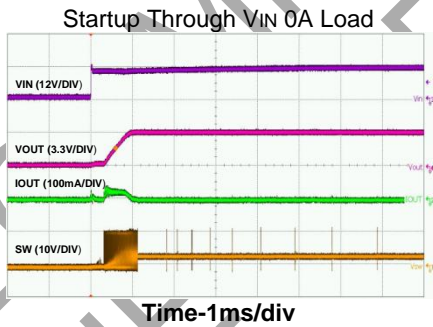
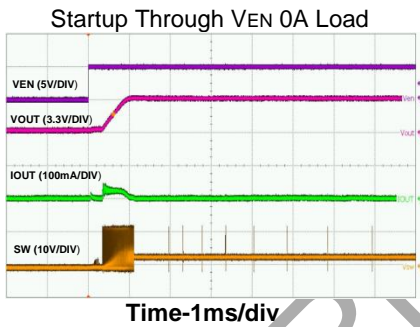
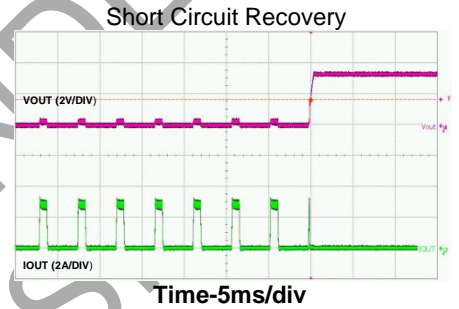
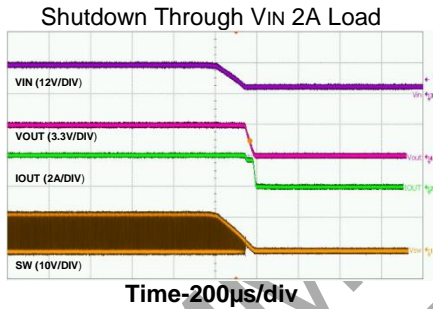
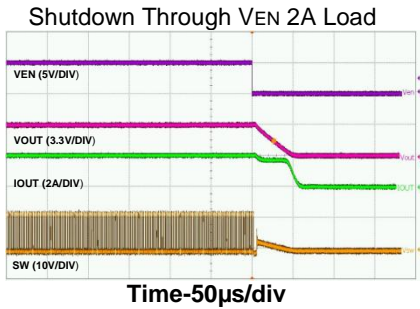
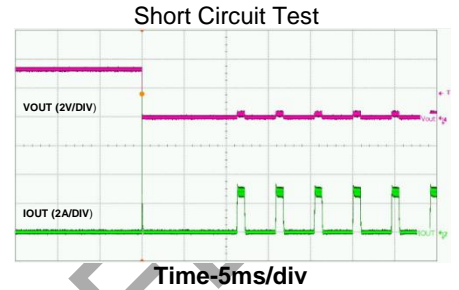
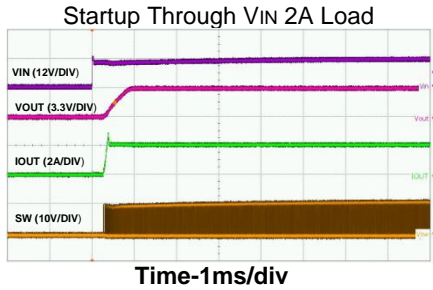
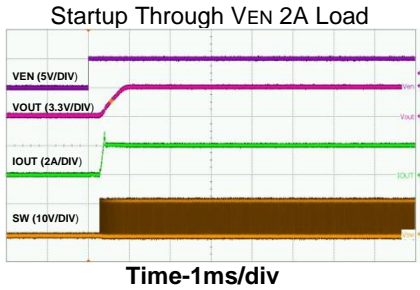

Application Information

Theory of Operation

The AP65201 is a 2A current mode control, synchronous buck regulator with built-in power MOSFETs. Current mode control assures excellent line and load regulation and a wide loop bandwidth for fast response to load transients. Figure 1 depicts the functional block diagram of AP65201.

The operation of one switching cycle can be explained as follows: The rising edge of the 500kHz oscillator clock signal sets the RS Flip-Flop. Its output turns on HS MOSFET. When the HS MOSFET is on, inductor current starts to increase. The current sense amplifier senses and amplifies the inductor current. Since the current mode control is subject to sub-harmonic oscillations that start at half of the switching frequency, ramp slope compensation is utilized. This will help to stabilize the power supply. This ramp compensation is summed to the current sense amplifier output and compared to the error amplifier output by the PWM comparator. When the sum of the current sense amplifier output and the slope compensation signal exceeds the EA output voltage, the RS Flip-Flop is reset and HS MOSFET is turned off.

When the HS MOSFET turns off, the synchronous LS MOSFET turns on until the next clock cycle begins. There is a "dead time" between the HS turn off and LS turn on that prevents the switches from "shooting through" from the input supply to ground.

For one whole cycle, if the sum of the current sense amplifier output and the slope compensation signal does not exceed the EA output, then the falling edge of the oscillator clock resets the Flip-Flop, and forces the MOSFET to turn off.

The voltage loop is compensated internally.

Enable

The enable (EN) input allows the user to control turning on or off the regulator. The AP65201 has an internal pull-down resistor on the EN pin and when the EN is not actively pulled up the part turns off.

Quiescent Current

Above the 'EN Rising Threshold', the internal regulator is turned on and the quiescent current can be measured above this threshold.

Automated No-Load and Light-Load Operation

The AP65201 operates in light load high efficiency mode during low load current operation. The advantage of this light load efficiency mode is lower power losses at no-load and light-load conditions. The AP65201 automatically detects the peak inductor current and enters the light load high efficiency mode when the inductor peak current goes below 500mA. Once the inductor peak current exceeds this level, the AP65201 transitions from light load high efficiency mode to continuous PWM mode.

Application Information (Cont.)

Current Limit Protection

In order to reduce the total power dissipation and to protect the application, AP65201 has cycle-by-cycle current limiting implementation. The voltage drop across the internal high-side MOSFET is sensed and compared with the internally set current limit threshold. This voltage drop is sensed at about 30ns after the HS turns on. When the peak inductor current exceeds the set current limit threshold, current limit protection is activated. When the voltage at the FB pin reaches 0.2V the device enters Hiccup mode to periodically restart the part. This protection mode greatly reduces the power dissipated on chip and reduces the thermal issue to protect the device. AP65201 will exit Hiccup mode when the over current situation is resolved.

Undervoltage Lockout (UVLO)

Undervoltage Lockout is implemented to prevent the IC from insufficient input voltages. The AP65201 has a UVLO comparator that monitors the input voltage and the internal bandgap reference. If the input voltage falls below 4.4V, the AP65201 will latch the undervoltage fault. In this event, the output will be pulled low and power has to be re-cycled to reset the UVLO fault.

Overvoltage Protection

When the AP65201 FB pin exceeds 115% of the nominal regulation voltage of 0.8V, the overvoltage comparator is tripped.

Thermal Shutdown

The AP65201 has on-chip thermal protection that prevents damage to the IC when the die temperature exceeds safe margins. It implements a thermal sensing to monitor the operating junction temperature of the IC. Once the die temperature rises to approximately +160°C, the thermal protection feature gets activated. The internal thermal sense circuitry turns the IC off thus preventing the power switch from damage. A hysteresis in the thermal sense circuit allows the device to cool down to approximately +120°C before the IC is enabled again through soft start. This thermal hysteresis feature prevents undesirable oscillations of the thermal protection circuit.

Setting the Output Voltage

The output voltage can be adjusted from 0.8V using an external resistor divider. Table 1 shows a list of resistor selection for common output voltages. Resistor R1 is selected based on a design tradeoff between efficiency and output voltage accuracy. For high values of R1 there is less current consumption in the feedback network. R1 can be determined by the following equation:

$$R_1 = R_2 \cdot \left(\frac{V_{OUT}}{0.8} - 1 \right)$$

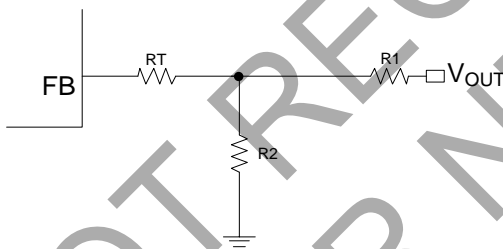

Figure 2. Feedback Divider Network

V _{OUT} (V)	R1 (kΩ)	R2 (kΩ)	RT (kΩ)	L1 (μH)
1.05	10	32.4	300	1.5
1.2	20.5	41.2	249	1.5
1.8	40.2	32.4	120	2.2
2.5	40.2	19.1	100	2.2
3.3	40.2	13	75	4.7
5	40.2	7.68	75	6.5

Table 1. Recommended Component Selection

Application Information (Cont.)

Inductor

Calculating the inductor value is a critical factor in designing a buck converter. For most designs, the following equation can be used to calculate the inductor value;

$$L = \frac{V_{OUT} \cdot (V_{IN} - V_{OUT})}{V_{IN} \cdot \Delta I_L \cdot f_{SW}}$$

Where ΔI_L is the inductor ripple current and f_{SW} is the buck converter switching frequency.

Choose the inductor ripple current to be 30% of the maximum load current. The maximum inductor peak current is calculated from:

$$I_{L(MAX)} = I_{LOAD} + \frac{\Delta I_L}{2}$$

Peak current determines the required saturation current rating, which influences the size of the inductor. Saturating the inductor decreases the converter efficiency while increasing the temperatures of the inductor and the internal MOSFETs. Hence choosing an inductor with appropriate saturation current rating is important.

A 1 μ H to 10 μ H inductor with a DC current rating of at least 25% higher than the maximum load current is recommended for most applications. For highest efficiency, the inductor's DC resistance should be less than 20m Ω . Use a larger inductance for improved efficiency under light load conditions.

Input Capacitor

The input capacitor reduces the surge current drawn from the input supply and the switching noise from the device. The input capacitor has to sustain the ripple current produced during the on time on the upper MOSFET. It must hence have a low ESR to minimize the losses.

The RMS current rating of the input capacitor is a critical parameter that must be higher than the RMS input current. As a rule of thumb, select an input capacitor which has RMS rating that is greater than half of the maximum load current.

Input Capacitor

The input capacitor reduces the surge current drawn from the input supply and the switching noise from the device. The input capacitor has to sustain the ripple current produced during the on time on the upper MOSFET. It must hence have a low ESR to minimize the losses.

The RMS current rating of the input capacitor is a critical parameter that must be higher than the RMS input current. As a rule of thumb, select an input capacitor which has RMS rating that is greater than half of the maximum load current.

Due to large di/dt through the input capacitors, electrolytic or ceramics should be used. If a tantalum must be used, it must be surge protected. Otherwise, capacitor failure could occur. For most applications, a 10/22 μ F ceramic capacitor is sufficient.

Output Capacitor

The output capacitor keeps the output voltage ripple small, ensures feedback loop stability and reduces the overshoot of the output voltage. The output capacitor is a basic component for the fast response of the power supply. In fact, during load transient, for the first few microseconds it supplies the current to the load. The converter recognizes the load transient and sets the duty cycle to maximum, but the current slope is limited by the inductor value.

Maximum capacitance required can be calculated from the following equation:

ESR of the output capacitor dominates the output voltage ripple. The amount of ripple can be calculated from the equation below:

$$V_{OUT_CAPACITOR} = \Delta I_{INDUCTOR} * ESR$$

An output capacitor with ample capacitance and low ESR is the best option. For most applications, a 22 μ F ceramic capacitor will be sufficient.

$$C_o = \frac{L(I_{OUT} + \frac{\Delta I_{INDUCTOR}}{2})^2}{(\Delta V + V_{OUT})^2 - V_{OUT}^2}$$

Where ΔV is the maximum output voltage overshoot.

Application Information (Cont.)

PC Board Layout

This is a high switching frequency converter. Hence, attention must be paid to the switching currents interference in the layout. Switching current from one power device to another can generate voltage transients across the impedances of the interconnecting bond wires and circuit traces. These interconnecting impedances should be minimized by using wide, short printed circuit traces.

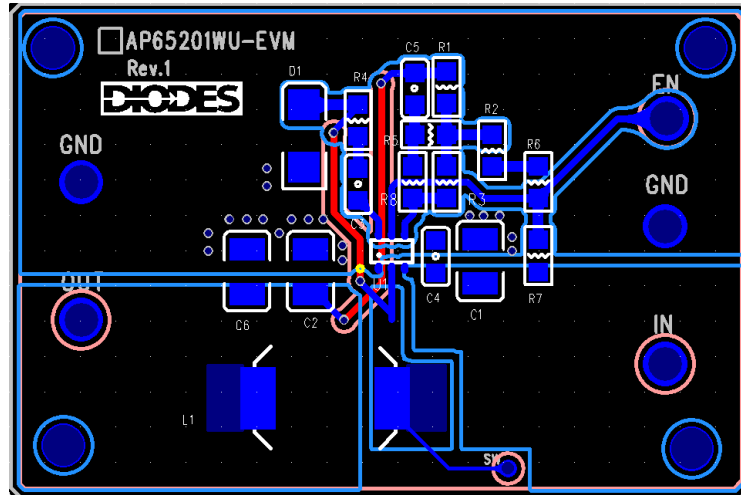

Figure 3—PC Board Layout

External Bootstrap Diode

It is recommended that an external bootstrap diode be added when the input voltage is no greater than 5V or the 5V rail is available in the system. This helps to improve the efficiency of the regulator. This solution is also applicable for $D > 65\%$. The bootstrap diode can be a low cost one such as BAT54 or a Schottky that has a low V_F .

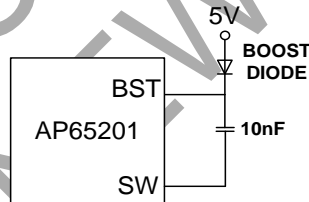
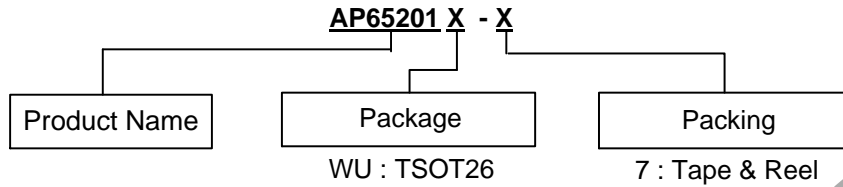

Figure 4—External Bootstrap Compensation Components

Recommended Diodes Incorporated:

Part Number	Voltage/Current Rating	Vendor
B130	30V, 1A	Diodes Incorporated
SK13	30V, 1A	Diodes Incorporated

Ordering Information



Part Number	Package Code	Package	Identification Code	Tape and Reel	
				Quantity	Part Number Suffix
AP65201WU-7	WU	TSOT26	SA	3,000	-7

Marking Information

(1) TSOT26

(Top View)

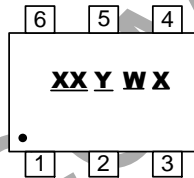

XX : Identification Code
Y : Year 0~9
W : Week : A~Z : 1~26 week;
 a~z : 27~52 week; z represents
 52 and 53 week
X : Internal Code

Part Number	Package	Identification Code
AP65201WU-7	TSOT26	SA

NOT RECOMMENDED FOR NEW DESIGN

Package Outline Dimensions

Please see <http://www.diodes.com/package-outlines.html> for the latest version.

(1) TSOT26

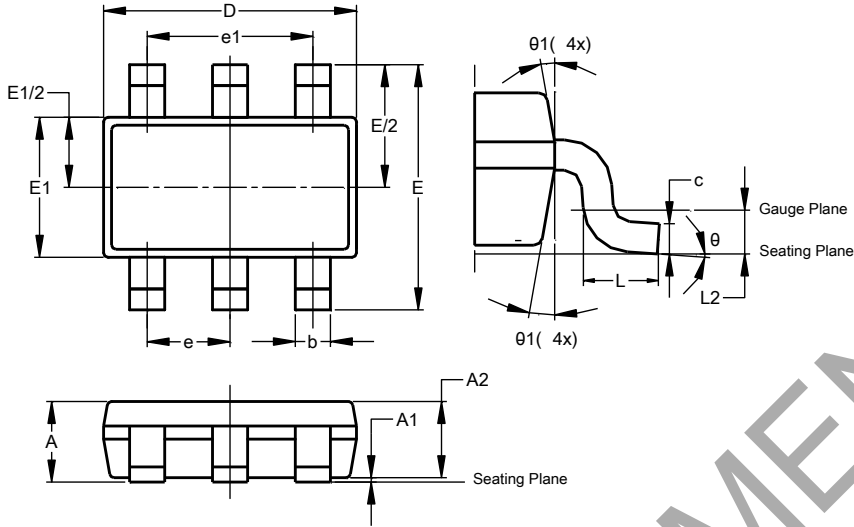

TSOT26			
Dim	Min	Max	Typ
A	–	1.00	–
A1	0.010	0.100	–
A2	0.840	0.900	–
D	2.800	3.000	2.900
E	2.800 BSC		
E1	1.500	1.700	1.600
b	0.300	0.450	–
c	0.120	0.200	–
e	0.950 BSC		
e1	1.900 BSC		
L	0.30	0.50	–
L2	0.250 BSC		
θ	0°	8°	4°
$\theta 1$	4°	12°	–
All Dimensions in mm			

Suggested Pad Layout

Please see <http://www.diodes.com/package-outlines.html> for the latest version.

(1) TSOT26

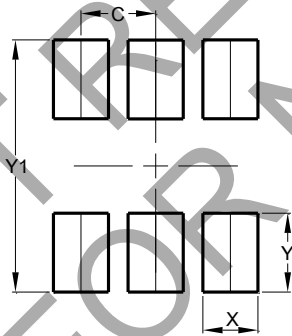

Dimensions	Value (in mm)
C	0.950
X	0.700
Y	1.000
Y1	3.199

IMPORTANT NOTICE

DIODES INCORPORATED MAKES NO WARRANTY OF ANY KIND, EXPRESS OR IMPLIED, WITH REGARDS TO THIS DOCUMENT, INCLUDING, BUT NOT LIMITED TO, THE IMPLIED WARRANTIES OF MERCHANTABILITY AND FITNESS FOR A PARTICULAR PURPOSE (AND THEIR EQUIVALENTS UNDER THE LAWS OF ANY JURISDICTION).

Diodes Incorporated and its subsidiaries reserve the right to make modifications, enhancements, improvements, corrections or other changes without further notice to this document and any product described herein. Diodes Incorporated does not assume any liability arising out of the application or use of this document or any product described herein; neither does Diodes Incorporated convey any license under its patent or trademark rights, nor the rights of others. Any Customer or user of this document or products described herein in such applications shall assume all risks of such use and will agree to hold Diodes Incorporated and all the companies whose products are represented on Diodes Incorporated website, harmless against all damages.

Diodes Incorporated does not warrant or accept any liability whatsoever in respect of any products purchased through unauthorized sales channel. Should Customers purchase or use Diodes Incorporated products for any unintended or unauthorized application, Customers shall indemnify and hold Diodes Incorporated and its representatives harmless against all claims, damages, expenses, and attorney fees arising out of, directly or indirectly, any claim of personal injury or death associated with such unintended or unauthorized application.

Products described herein may be covered by one or more United States, international or foreign patents pending. Product names and markings noted herein may also be covered by one or more United States, international or foreign trademarks.

This document is written in English but may be translated into multiple languages for reference. Only the English version of this document is the final and determinative format released by Diodes Incorporated.

LIFE SUPPORT

Diodes Incorporated products are specifically not authorized for use as critical components in life support devices or systems without the express written approval of the Chief Executive Officer of Diodes Incorporated. As used herein:

A. Life support devices or systems are devices or systems which:

1. are intended to implant into the body, or
2. support or sustain life and whose failure to perform when properly used in accordance with instructions for use provided in the labeling can be reasonably expected to result in significant injury to the user.

B. A critical component is any component in a life support device or system whose failure to perform can be reasonably expected to cause the failure of the life support device or to affect its safety or effectiveness.

Customers represent that they have all necessary expertise in the safety and regulatory ramifications of their life support devices or systems, and acknowledge and agree that they are solely responsible for all legal, regulatory and safety-related requirements concerning their products and any use of Diodes Incorporated products in such safety-critical, life support devices or systems, notwithstanding any devices- or systems-related information or support that may be provided by Diodes Incorporated. Further, Customers must fully indemnify Diodes Incorporated and its representatives against any damages arising out of the use of Diodes Incorporated products in such safety-critical, life support devices or systems.

Copyright © 2016, Diodes Incorporated

www.diodes.com