



SOT-363 Plastic-Encapsulate Diodes

CESD5V0K5 Quad-direction ESD Protection Array

DESCRIPTION

Designed to protect voltage sensitive electronic components from ESD and other transients. Excellent clamping capability, low leakage, low capacitance, and fast response time provide best in class protection on designs that are exposed to ESD.

The combination of small size, low capacitance, and high level of ESD protection makes them a flexible solution for applications such as HDMI, Display Port TM, and MDDI interfaces. It is designed to replace multiplayer varistors (MLV) in consumer equipments applications such as mobile phone, notebook, PAD, STB, LCD TV etc.

SOT-363

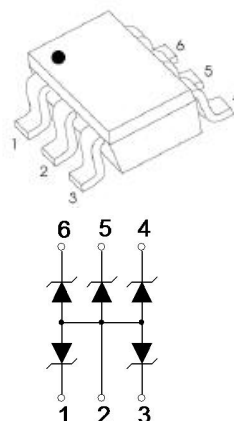

FEATURES

- Uni-directional ESD protection of five lines
- Low reverse stand-off voltage: 5V
- Low reverse clamping voltage
- Low leakage current
- Excellent package: 2.10mm × 1.25mm × 0.96mm
- Fast response time
- JESD22-A114-B ESD Rating of class 3B per human body model
- IEC 61000-4-2 Level 4 ESD protection

APPLICATIONS

- Computers and peripherals
- Audio and video equipment
- Cellular handsets and accessories
- Portable electronics
- Other electronics equipments communication systems

MARKING

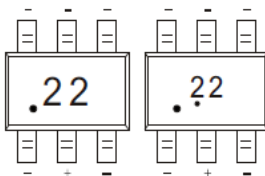

Front side

22 = Device code

Solid dot=Pin1 indicator

Solid dot = Green molding compound device, if none, the normal device

MAXIMUM RATINGS (T_a=25°C unless otherwise noted)

Parameter	Symbol	Limit	Unit
IEC 61000-4-2 ESD Voltage	Air Model	±25	kV
	Contact Model	±25	
	Per Human Body Model	±16	
	Machine Model	±0.4	
JESD22-A114-B ESD Voltage	V _{ESD} ⁽¹⁾		
ESD Voltage	P _{PP} ⁽²⁾	60	W
Peak Pulse Power	I _{PP} ⁽²⁾	5	A
Peak Pulse Current	T _L	260	°C
Lead Solder Temperature - Maximum (10 Second Duration)	T _j	150	°C
Junction Temperature	T _{stg}	-55 ~ +150	°C
Storage Temperature Range			

(1).Device stressed with ten non-repetitive ESD pulses, Per channel(I/O to GND).

(2).Non-repetitive current pulse 8/20µs exponential decay waveform according to IEC61000-4-5.

ESD standards compliance

IEC61000-4-2 Standard

Contact Discharge		Air Discharge	
Level	Test Voltage kV	Level	Test Voltage kV
1	2	1	2
2	4	2	4
3	6	3	8
4	8	4	15

JESD22-A114-B Standard

ESD Class	Human Body Discharge V
0	0~249
1A	250~499
1B	500~999
1C	1000~1999
2	2000~3999
3A	4000~7999
3B	8000~15999



ESD pulse waveform according to IEC61000-4-2

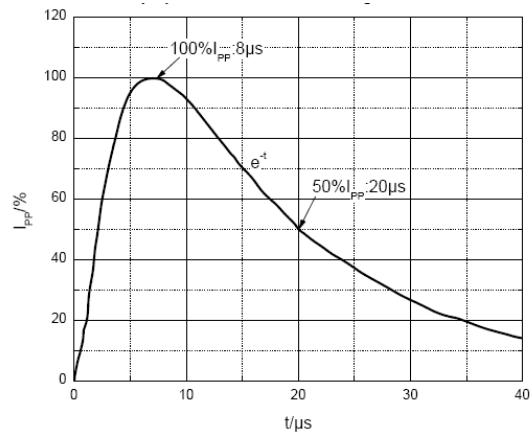

8/20µs pulse waveform according to IEC 61000-4-5

ELECTRICAL PARAMETER

Symbol	Parameter
V_C	Clamping Voltage @ I_{PP}
I_{PP}	Peak Pulse Current
V_{BR}	Breakdown Voltage @ I_T
I_T	Test Current
I_R	Reverse Leakage Current @ V_{RWM}
V_{RWM}	Reverse Standoff Voltage
V_F	Forward Voltage@ I_F
I_F	Forward Current

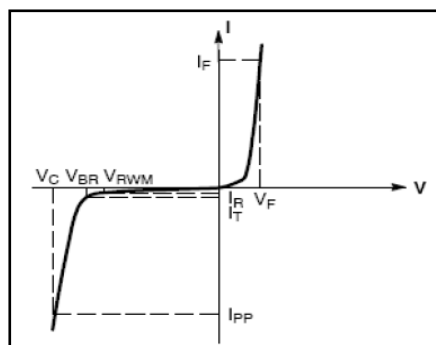

V-I characteristics for a uni-directional TVS

ELECTRICAL CHARACTERISTICS($T_a=25^{\circ}C$ unless otherwise specified)

Parameter	Symbol	Test conditions	Min	Typ	Max	Unit
Per Diode						
Reverse stand off voltage	$V_{RWM}^{(1)}$				5	V
Breakdown voltage	$V_{(BR)}$	$I_T=1mA$	6.0		7.2	V
Reverse leakage current	I_R	$V_{RWM}=5V$			5.0	μA
Forward voltage	V_F	$I_F=10mA$			0.9	V
Clamping voltage	$V_C^{(2)}$	$I_{PP}=5A$			12	V
Junction capacitance	C_J	$V_R=0V, f=1MHz$		30		pF

(1).Other voltages available upon request.

(2).Non-repetitive current pulse 8/20 μs exponential decay waveform according to IEC61000-4-5

TYPICAL CHARACTERISTICS

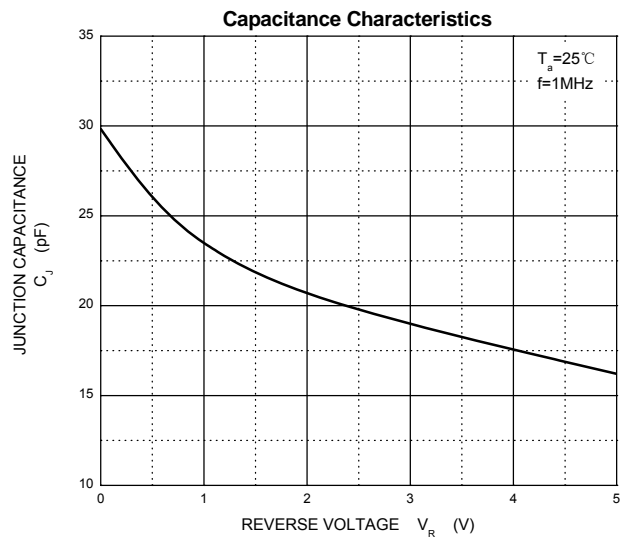
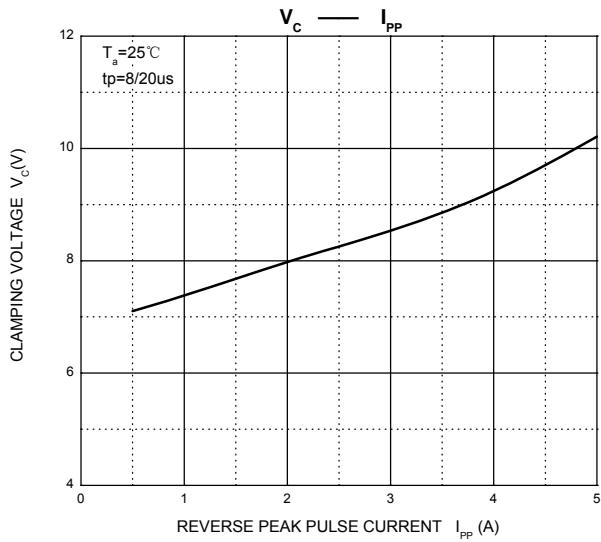
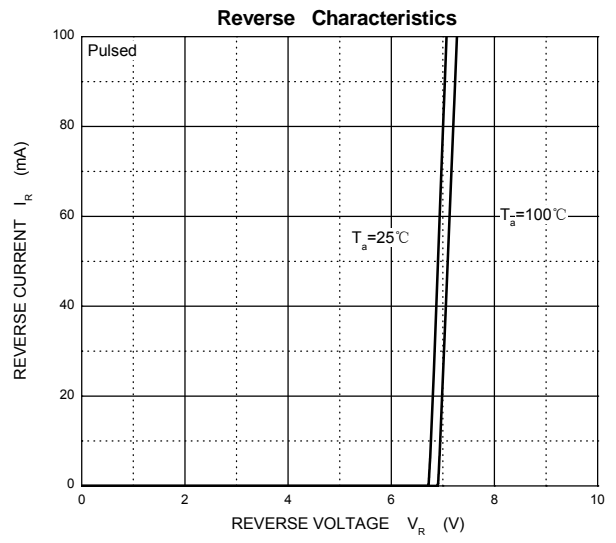
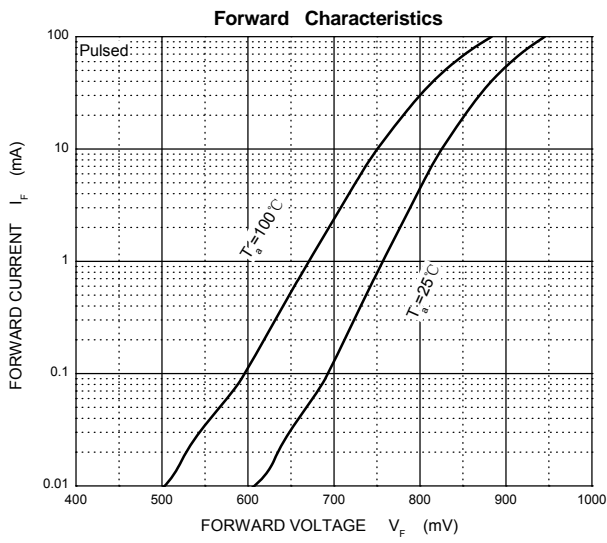

PACKAGE OUTLINE AND PAD LAYOUT INFORMATION

SOT-363 Package Outline Dimensions

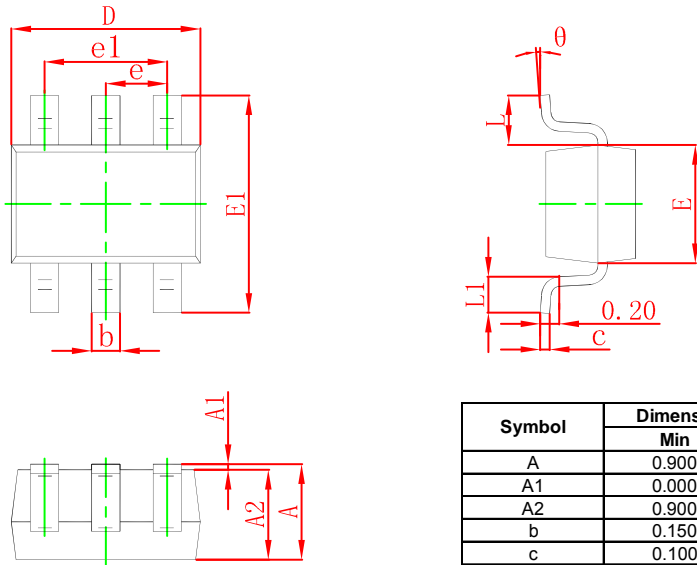

Symbol	Dimensions In Millimeters		Dimensions In Inches	
	Min	Max	Min	Max
A	0.900	1.100	0.035	0.043
A1	0.000	0.100	0.000	0.004
A2	0.900	1.000	0.035	0.039
b	0.150	0.350	0.006	0.014
c	0.100	0.150	0.004	0.006
D	2.000	2.200	0.079	0.087
E	1.150	1.350	0.045	0.053
E1	2.150	2.400	0.085	0.094
e	0.650 TYP		0.026 TYP	
e1	1.200	1.400	0.047	0.055
L	0.525 REF		0.021 REF	
L1	0.260	0.460	0.010	0.018
theta	0°	8°	0°	8°

SOT-363 Suggested Pad Layout

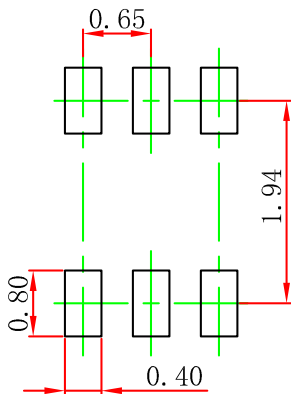

- Note:
1. Controlling dimension: in millimeters.
 2. General tolerance: $\pm 0.05\text{mm}$.
 3. The pad layout is for reference purposes only.

NOTICE

JCET reserve the right to make modifications, enhancements, improvements, corrections or other changes without further notice to any product herein. JCET does not assume any liability arising out of the application or use of any product described herein.

TAPE AND REEL INFORMATION

SOT-363 Embossed Carrier Tape

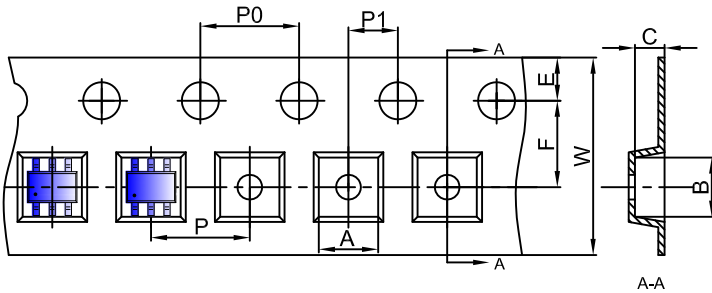

Packaging Description:

SOT-363 parts are shipped in tape. The carrier tape is made from a dissipative (carbon filled) polycarbonate resin. The cover tape is a multilayer film (Heat Activated Adhesive in nature) primarily composed of polyester film, adhesive layer, sealant, and anti-static sprayed agent. These reeled parts in standard option are shipped with 3,000 units per 7" or 17.8cm diameter reel. The reels are clear in color and is made of polystyrene plastic (anti-static coated).

Dimensions are in millimeter											
Pkg type	A	B	C	d	E	F	P0	P	P1	W	
SOT-363	2.25	2.55	1.20	Ø1.50	1.75	3.50	4.00	4.00	2.00	8.00	

SOT-363 Tape Leader and Trailer

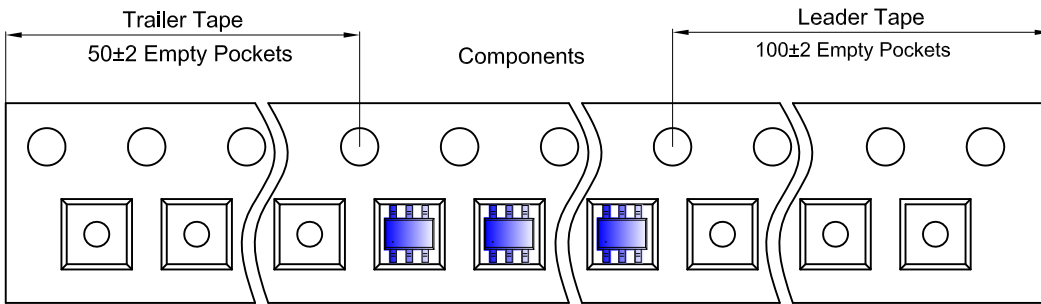

SOT-363 Reel

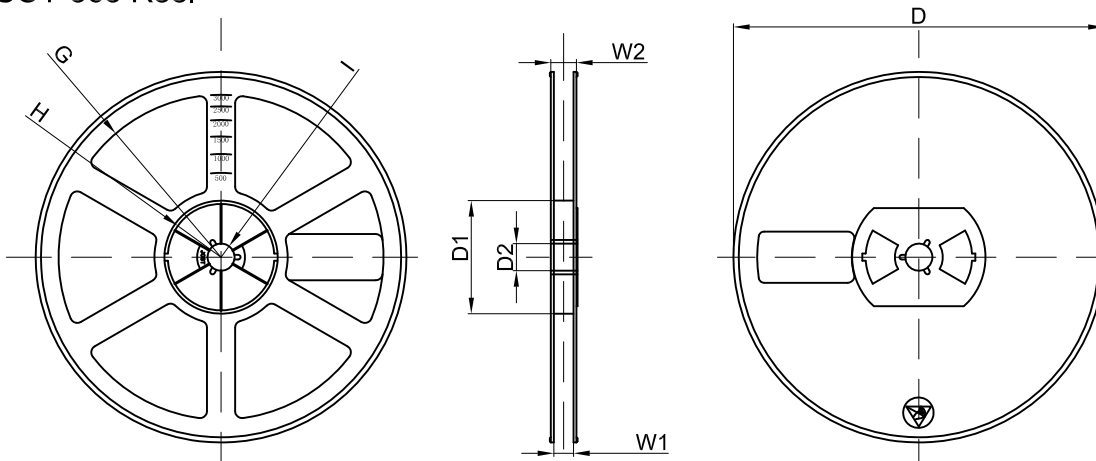

Dimensions are in millimeter								
Reel Option	D	D1	D2	G	H	I	W1	W2
7" Dia	Ø178.00	54.40	13.00	R78.00	R25.60	R6.50	9.50	12.30

REEL	Reel Size	Box	Box Size(mm)	Carton	Carton Size(mm)	G.W.(kg)
3000 pcs	7 inch	45,000 pcs	203×203×195	180,000 pcs	438×438×220	