

## SOD-523 Plastic-Encapsulate Diodes

### CESD7V0D5 Uni-direction ESD Protection Diode

#### DESCRIPTION

Designed to protect voltage sensitive electronic components from ESD and other transients. Excellent clamping capability, low leakage, and fast response time provide best in class protection on designs that are exposed to ESD.

The combination of small size, high level of ESD protection makes them a flexible solution for applications such as HDMI, Display Port TM, and MDDI interfaces. It is designed to replace multilayer varistors (MLV) in consumer equipments applications such as mobile phone, notebook, PAD, STB, LCD TV etc.

#### SOD-523

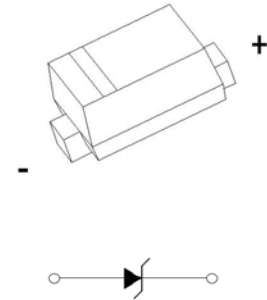

#### FEATURES

- Uni-directional ESD protection of one line
- Reverse stand-off voltage: 7V
- Low reverse clamping voltage
- Low leakage current
- Excellent package: 1.20mm × 0.80mm × 0.60mm
- Fast response time
- JESD22-A114-B ESD Rating of class 3B per human body model
- IEC 61000-4-2 Level 4 ESD protection

#### APPLICATIONS

- Computers and peripherals
- Audio and video equipment
- 10/100/1000 Mbit/s Ethernet
- Cellular handsets and accessories
- Portable electronics
- FireWire
- Other electronics equipments communication systems

#### MARKING

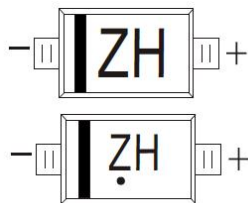

Front side

ZH = Device code

Solid dot = Green molding compound device, if none, the normal device

The marking bar indicates the cathode

**MAXIMUM RATINGS (  $T_a=25^{\circ}\text{C}$  unless otherwise noted )**

Parameter	Symbol	Limit	Unit
IEC 61000-4-2 ESD Voltage	Air Model	$\pm 25$	kV
	Contact Model	$\pm 25$	
	Per Human Body Model	$\pm 16$	
	Machine Model	$\pm 0.4$	
JESD22-A114-B ESD Voltage	$V_{\text{ESD}}^{(1)}$		
ESD Voltage			
Peak Pulse Power	$P_{\text{PP}}^{(2)}$	150	W
Peak Pulse Current	$I_{\text{PP}}^{(2)}$	10	A
Lead Solder Temperature – Maximum (10 Second Duration)	$T_L$	260	$^{\circ}\text{C}$
Junction Temperature	$T_j$	150	$^{\circ}\text{C}$
Storage Temperature Range	$T_{\text{stg}}$	-55 ~ +150	$^{\circ}\text{C}$

(1).Device stressed with ten non-repetitive ESD pulses.

(2).Non-repetitive current pulse 8/20 $\mu\text{s}$  exponential decay waveform according to IEC61000-4-5.

**ESD standards compliance**

**IEC61000-4-2 Standard**

Contact Discharge		Air Discharge	
Level	Test Voltage kV	Level	Test Voltage kV
1	2	1	2
2	4	2	4
3	6	3	8
4	8	4	15

**JESD22-A114-B Standard**

ESD Class	Human Body Discharge V
0	0~249
1A	250~499
1B	500~999
1C	1000~1999
2	2000~3999
3A	4000~7999
3B	8000~15999

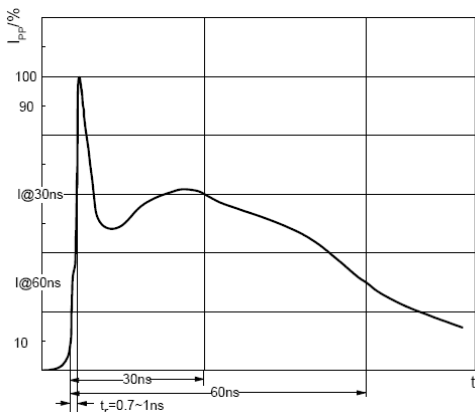

ESD pulse waveform according to IEC61000-4-2

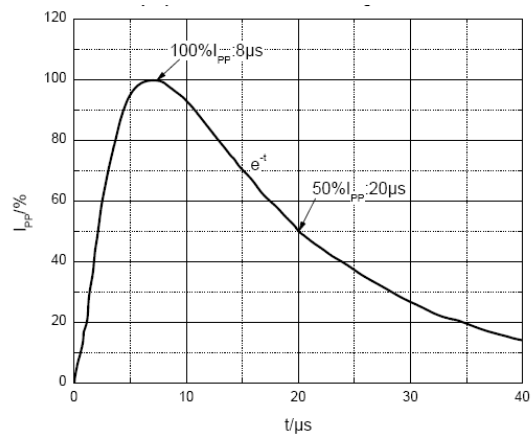

8/20 $\mu\text{s}$  pulse waveform according to IEC 61000-4-5

**ELECTRICAL PARAMETER**

Symbol	Parameter
$V_C$	Clamping Voltage @ $I_{PP}$
$I_{PP}$	Peak Pulse Current
$V_{BR}$	Breakdown Voltage @ $I_T$
$I_T$	Test Current
$I_R$	Reverse Leakage Current @ $V_{RWM}$
$V_{RWM}$	Reverse Standoff Voltage
$V_F$	Forward Voltage@ $I_F$
$I_F$	Forward Current

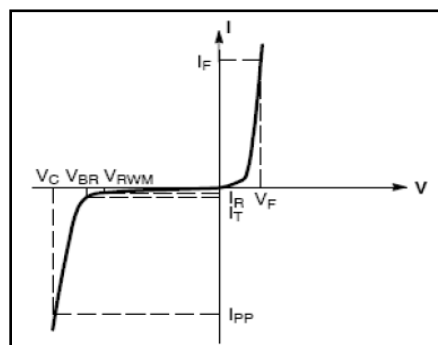

V-I characteristics for a uni-directional TVS

**ELECTRICAL CHARACTERISTICS( $T_a=25^{\circ}C$  unless otherwise specified)**

Parameter	Symbol	Test conditions	Min	Typ	Max	Unit
Reverse stand off voltage	$V_{RWM}^{(1)}$				7.0	V
Reverse leakage current	$I_R$	$V_{RWM}=7.0V$			30	nA
Breakdown voltage	$V_{(BR)}$	$I_T=1mA$	7.5		8.7	V
Clamping voltage	$V_C^{(2)}$	$I_{PP}=10A$			15.1	V
Forward voltage	$V_F$	$I_F=10mA$			0.9	V
Junction capacitance	$C_J$	$V_R=0V, f=1MHz$		70		pF

(1).Other voltages available upon request.

(2).Non-repetitive current pulse 8/20 $\mu s$  exponential decay waveform according to IEC61000-4-5

TYPICAL CHARACTERISTICS

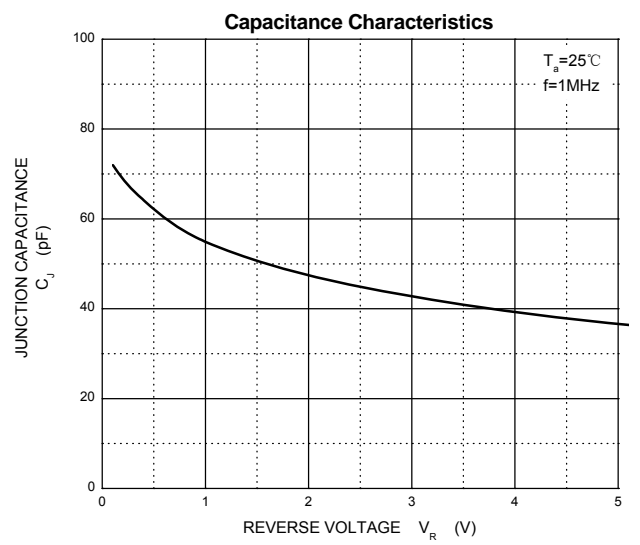
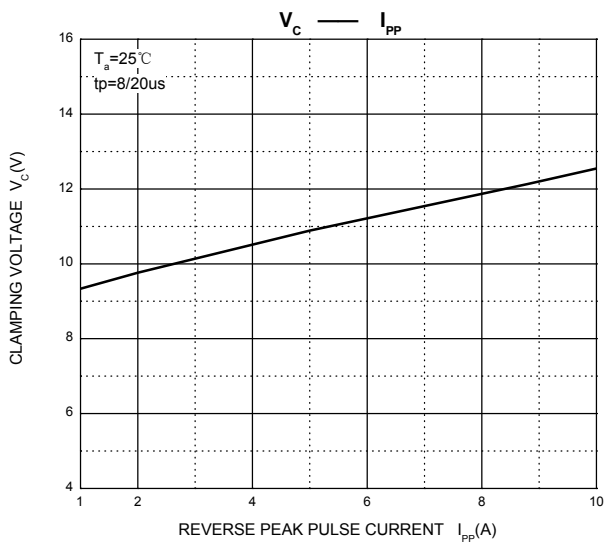
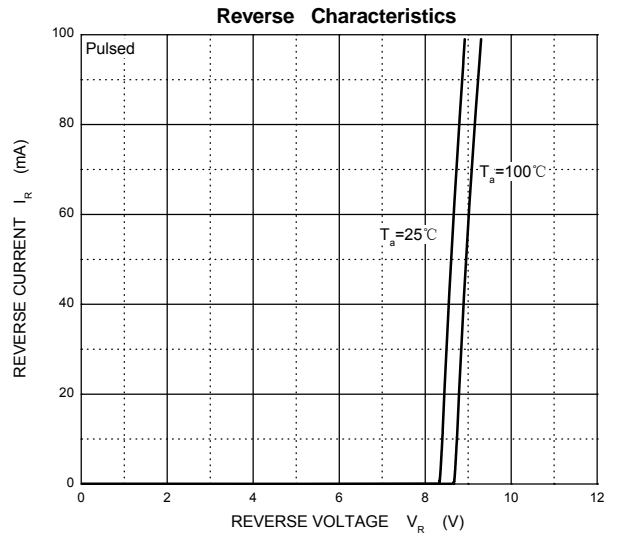
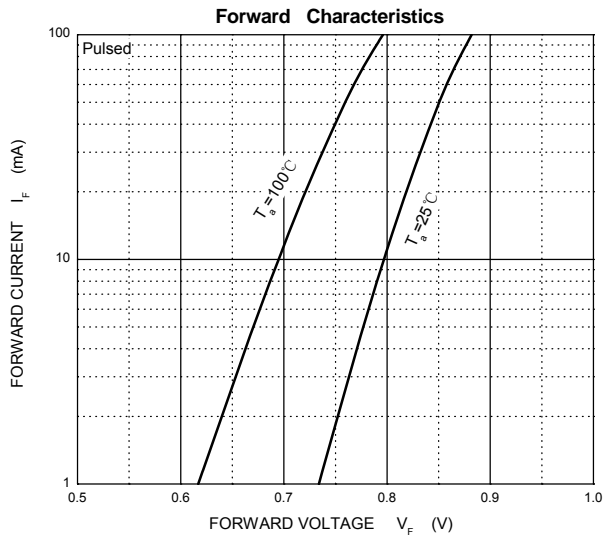

PACKAGE OUTLINE AND PAD LAYOUT INFORMATION

SOD-523 Package Outline Dimensions

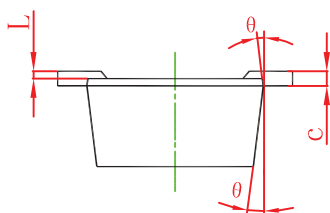
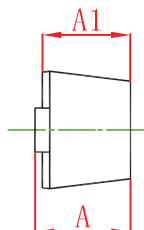
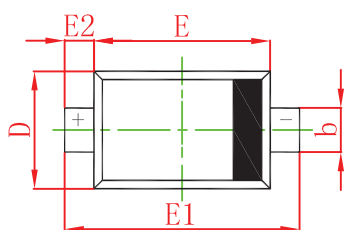

Symbol	Dimensions In Millimeters		Dimensions In Inches	
	Min	Max	Min	Max
A	0.510	0.770	0.020	0.031
A1	0.500	0.700	0.020	0.028
b	0.250	0.350	0.010	0.014
c	0.080	0.150	0.003	0.006
D	0.750	0.850	0.030	0.033
E	1.100	1.300	0.043	0.051
E1	1.500	1.700	0.059	0.067
E2	0.200 REF		0.008 REF	
L	0.010	0.070	0.001	0.003
theta	7° REF		7° REF	

SOD-523 Suggested Pad Layout

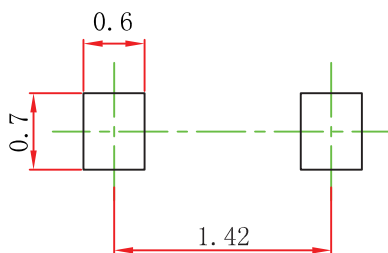

Note:

1. Controlling dimension: In millimeters.
2. General tolerance: ± 0.05mm.
3. The pad layout is for reference purposes only.

NOTICE

JCET reserve the right to make modifications, enhancements, improvements, corrections or other changes without further notice to any product herein. JCET does not assume any liability arising out of the application or use of any product described herein.

**TAPE AND REEL INFORMATION**

**SOD-523 Embossed Carrier Tape**

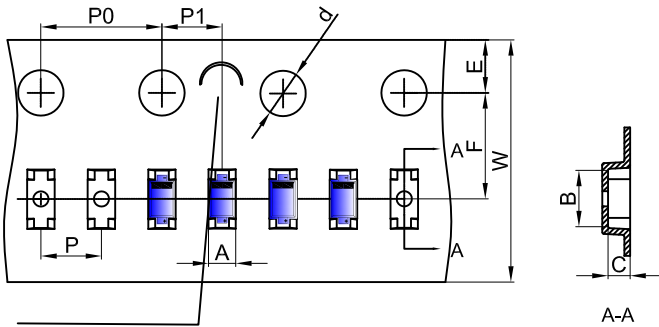

**Packaging Description:**

SOD-523 parts are shipped in tape. The carrier tape is made from a dissipative (carbon filled) polycarbonate resin. The cover tape is a multilayer film (Heat Activated Adhesive in nature) primarily composed of polyester film, adhesive layer, sealant, and anti-static sprayed agent. These reeled parts in standard option are shipped with 8,000 units per 7" or 17.8cm diameter reel. The reels are clear in color and is made of polystyrene plastic (anti-static coated).

NOTE: TO GAVE 'C' ON CARRIER TAPE PER 120MM

Dimensions are in millimeter										
Pkg type	A	B	C	d	E	F	P0	P	P1	W
SOD-523	0.9	1.94	0.73	Ø1.50	1.75	3.50	4.00	2.00	2.00	8.00

**SOD-523 Tape Leader and Trailer**

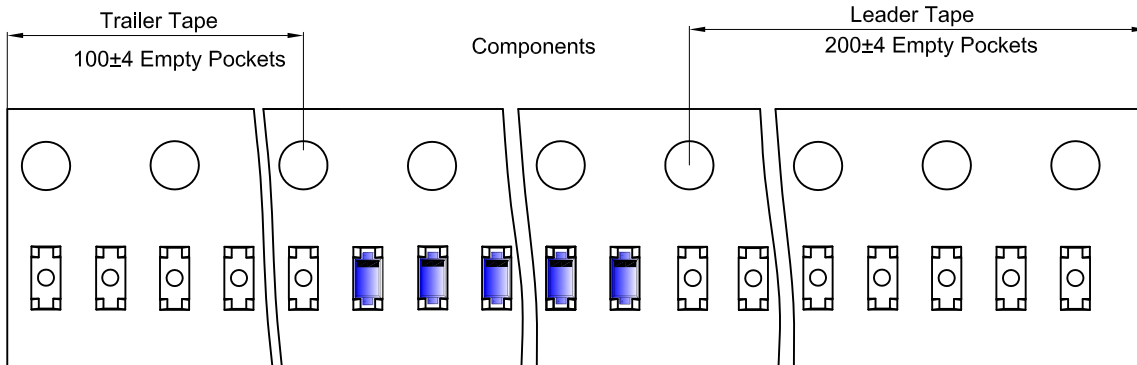

**SOD-523 Reel**

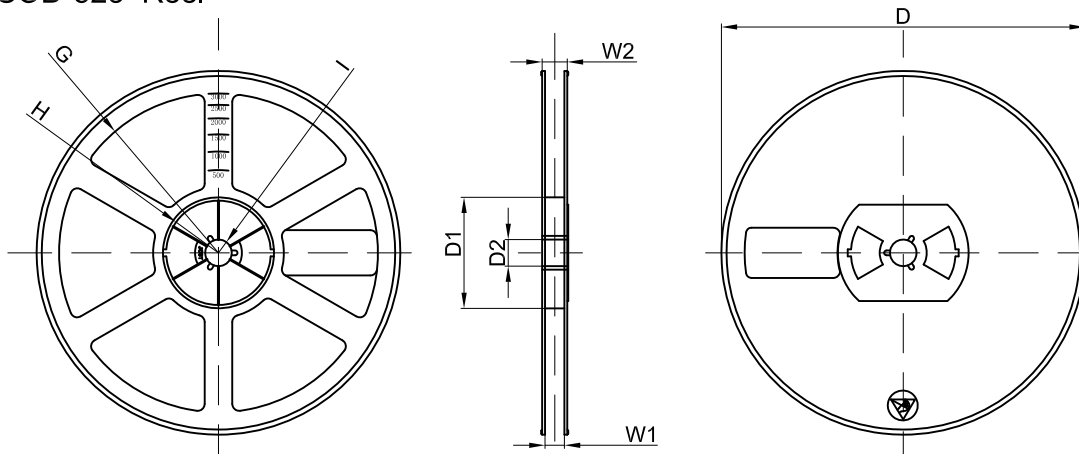

Dimensions are in millimeter								
Reel Option	D	D1	D2	G	H	I	W1	W2
7" Dia	Ø178.00	54.40	13.00	R78.00	R25.60	R6.50	9.50	12.30

REEL	Reel Size	Box	Box Size(mm)	Carton	Carton Size(mm)	G.W.(kg)
8000 pcs	7 inch	120,000 pcs	203×203×195	480,000 pcs	438×438×220	