



Thin-Film Cascadable Amplifier 1700 to 2300 MHz

Technical Data

UTO/UTC 2321 Series

Features

- **Frequency Range: 1700 to 2300 MHz**
- **Medium Gain: 15.0 dB (Typ)**
- **Medium Output Power: +12.0 dBm (Typ)**
- **Temperature Compensated**

Applications

- **IF/RF Amplification**
- **Telemetry**
- **Military Communications**

Description

The 2321 Series is a two-stage thin-film bipolar RF amplifier using resistive feedback and active bias or temperature compensation and increased Immunity to bias voltage variations. Input/output blocking capacitors couple RF through the amplifier while a low VSWR is maintained through inductive tuning. The 2321 Series amplifiers are available in either the TO-8 hermetic case or connected TC-1A package.

Pin Configuration

UTO—TO-8U

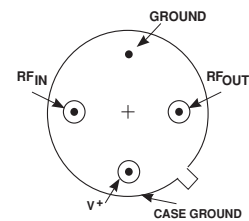

UTC—TC-1A

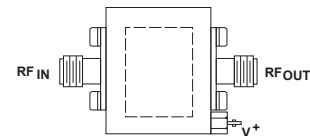

Schematic

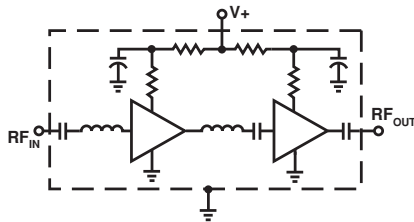

Maximum Ratings

Parameter	Maximum
DC Voltage	+17 Volts
Continuous RF Input Power	+18 dBm
Operating Case Temperature	-55 to +115°C
Storage Temperature	-62 to +150°C
“R” Series Burn-In Temperature	+115°C

Thermal Characteristics¹

θ_{JC}	105/75°C/W ²
Active Transistor Power Dissipation	180/450 mW ²
Junction Temperature Above Case Temperature	19/34°C ²
MTBF (MIL-HDBK-217E, A _{UF} @ 90°C)	366,000 Hrs.

Notes:

1. Values refer to first and second stages, respectively.

Weight: (typical) UTO—2.1 grams; UTC—21.5 grams

Electrical Specifications

(Measured in 50 Ω system @ +15 VDC nominal unless otherwise noted)

Symbol	Characteristic	Typical $T_C = 25^\circ\text{C}$	Guaranteed Specifications		Unit
			$T_C = 0 \text{ to } 50^\circ\text{C}$	$T_C = -55 \text{ to } +85^\circ\text{C}$	
BW	Frequency Range	1700-2300	1700-2300	1700-2300	MHz
GP	Small Signal Gain (Min.)	15.0	14.0	13.0	dB
—	Gain Flatness (Max.)	± 0.5	± 1.0	± 1.0	dB
NF	Noise Figure (Max.)	7.0	8.0	8.5	dB
P_{1dB}	Power Output @ +1 dB Comp. (Min.)	+12.0	+10.0	+9.0	dBm
—	Input VSWR (Max.)	<1.8:1	2.0:1	2.0:1	—
—	Output VSWR (Max.)	<1.6:1	2.0:1	2.0:1	—
IP_3	Two Tone 3rd Order Intercept Point	+20.0	—	—	dBm
IP_2	Two Tone 2nd Order Intercept Point	+35.0	—	—	dBm
HP_2	One Tone 2nd Harmonic Intercept Point	+41.0	—	—	dBm
I_D	DC Current	70	—	—	mA

Typical Performance Over Temperature (@ +15 VDC unless otherwise noted)

Key: $+25^\circ\text{C}$ —
 $+85^\circ\text{C}$ - -
 -55°C —

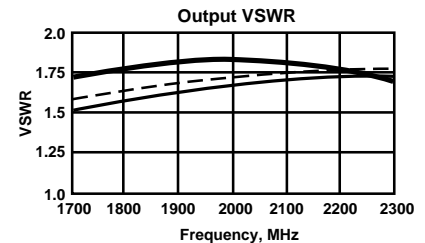
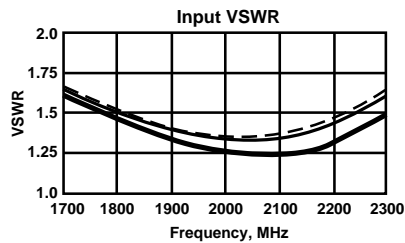
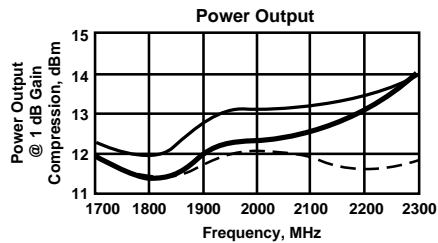
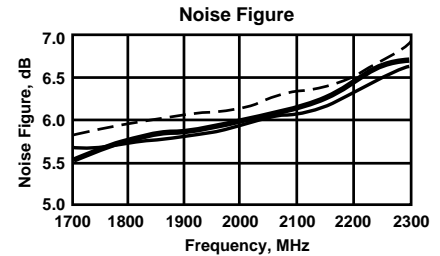
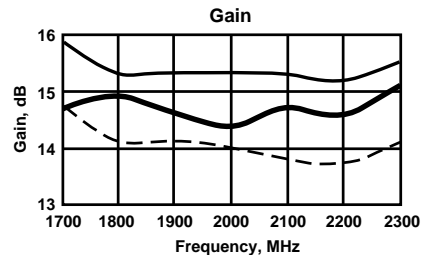

Automatic Network Analyzer Measurements (Typical production unit @ +25°C ambient)

Numerical Readings
Bias = 15.00 Volts

FREQUENCY MHz	VSWR IN	GAIN dB	PHASE DEGREES	PHASE DEV	GROUP DELAY ns	VSWR OUT	ISOLATION dB
500.0	2.53	14.27	54.15	—	1.01	3.86	42.19
600.0	2.05	15.40	20.93	—	.85	3.00	40.12
700.0	2.01	15.93	-7.33	—	.73	2.46	39.51
800.0	2.08	16.27	-31.37	—	.62	2.06	38.85
900.0	2.21	16.21	-52.07	—	.54	1.76	38.36
1000.0	2.27	16.06	-69.93	—	.48	1.53	38.49
1100.0	2.30	15.76	-86.55	—	.44	1.35	38.20
1200.0	2.29	15.60	-101.64	—	.40	1.24	37.76
1300.0	2.19	15.32	-115.02	—	.37	1.18	37.69
1400.0	2.13	15.01	-128.55	—	.37	1.19	38.03
1500.0	2.00	14.80	-141.86	—	.38	1.25	37.94
1600.0	1.88	14.76	-155.69	—	.37	1.34	37.77
1700.0	1.72	14.80	-168.27	-1.95	.34	1.43	37.71
1800.0	1.58	14.52	179.58	.04	.35	1.57	36.65
1900.0	1.49	15.00	166.56	1.17	.37	1.56	38.68
2000.0	1.40	15.05	152.69	1.46	.39	1.64	38.57
2100.0	1.41	14.98	138.50	1.43	.42	1.67	38.64
2200.0	1.56	15.10	122.45	-.45	.44	1.67	38.95
2300.0	1.82	15.12	107.05	-1.70	.47	1.66	39.53
2400.0	2.21	14.67	88.70	—	.52	1.61	39.45
2600.0	2.66	13.97	69.28	—	.50	1.55	39.21
2600.0	3.09	13.37	52.57	—	.48	1.48	40.23
2700.0	3.55	12.22	34.59	—	.48	1.43	40.52
2800.0	4.06	10.99	17.92	—	.46	1.43	40.94
2900.0	4.70	9.38	1.18	—	.44	1.49	40.95
3000.0	5.33	7.77	-13.79	—	.00	1.60	40.96

Linearization Range: 1700 to 2300 MHz

S-Parameters
Bias = 15.00 Volts

FREQUENCY MHz	S ₁₁		S ₂₁		S ₁₂		S ₂₂	
	Mag	Ang	dB	Ang	dB	Ang	Mag	Ang
500.00	.437	-73.5	13.952	53.4	-42.019	134.1	.580	-72.0
600.00	.345	-67.1	15.169	21.3	-40.348	119.9	.490	-82.5
700.00	.328	-60.8	15.698	-6.4	-39.169	110.8	.410	-91.8
800.00	.363	-57.9	16.076	-30.6	-38.765	107.2	.328	-99.6
900.00	.371	-59.1	16.066	-50.9	-38.267	103.3	.246	-106.8
1000.00	.398	-67.1	15.983	-68.5	-38.026	99.8	.179	-112.1
1100.00	.411	-71.3	15.653	-85.2	-38.166	98.3	.123	-111.9
1200.00	.400	-78.6	15.569	-100.2	-37.669	99.9	.080	-99.9
1300.00	.400	-84.8	15.309	-113.8	-37.939	96.8	.062	-68.1
1400.00	.378	-91.3	15.062	-127.4	-37.710	95.8	.075	-40.3
1500.00	.363	-98.9	14.850	-141.0	-37.955	96.6	.103	-32.4
1600.00	.332	-104.7	14.837	-154.9	-37.930	97.0	.136	-31.2
1700.00	.290	-115.0	14.881	-167.8	-37.876	97.1	.165	-33.2
1800.00	.248	-119.4	14.601	-179.9	-36.654	85.3	.202	-43.6
1900.00	.207	-141.5	15.025	166.9	-38.709	91.2	.197	-44.0
2000.00	.169	-169.3	15.065	152.9	-38.586	91.4	.222	-50.7
2100.00	.148	152.0	15.016	138.7	-38.698	89.0	.229	-54.8
2200.00	.186	113.9	15.133	122.9	-38.997	87.7	.226	-59.9
2300.00	.259	85.4	15.155	107.5	-39.194	83.2	.225	-64.5
2400.00	.356	68.3	14.712	89.1	-39.515	81.7	.211	-67.6
2500.00	.440	54.2	14.071	69.7	-39.410	72.8	.192	-66.9
2600.00	.511	43.3	13.453	52.9	-40.173	69.1	.168	-66.4
2700.00	.566	34.5	12.331	34.8	-40.402	62.8	.149	-59.0
2800.00	.621	27.6	11.064	17.8	-40.704	62.7	.150	-47.2
2900.00	.605	23.1	9.439	1.2	-40.619	56.0	.172	-37.2
3000.00	.704	18.6	7.761	-14.1	-40.887	56.3	.204	-33.2

Product Options

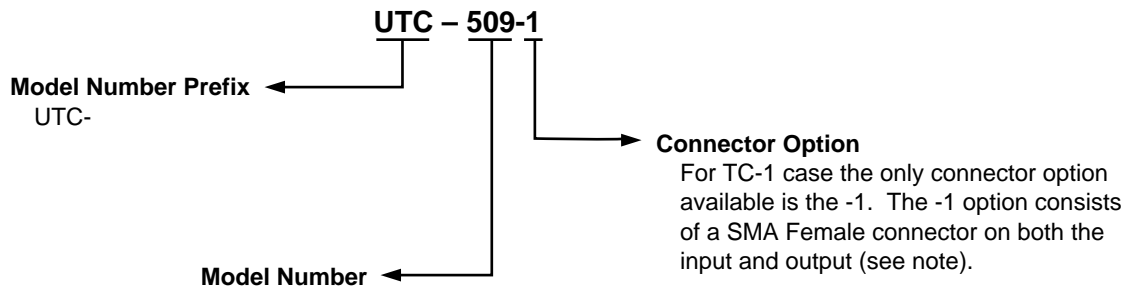
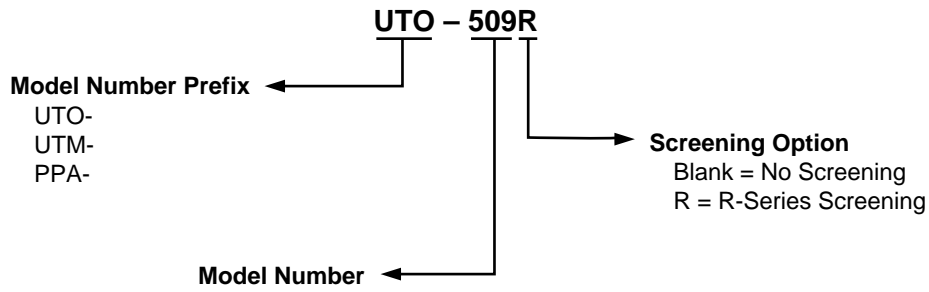

Note: R-Series screening is not available in the TC-1 case as the case is non-hermetic.

**Case Drawings
TO-8U**

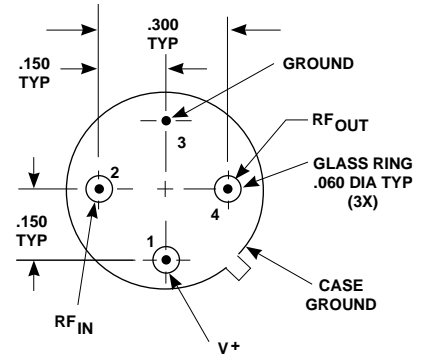
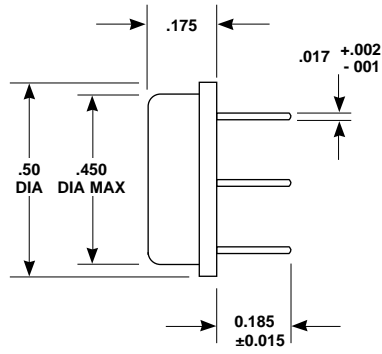
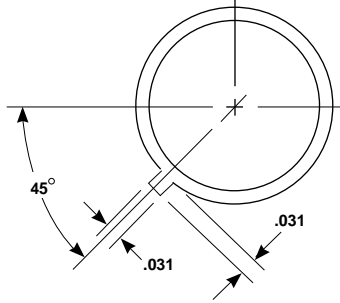

APPROXIMATE WEIGHT 2.1 GRAMS

- NOTES (UNLESS OTHERWISE SPECIFIED):**
1. DIMENSIONS ARE SPECIFIED IN INCHES
 2. TOLERANCES: xx ±.02
 xxx ±.010

Case Drawings TC-1

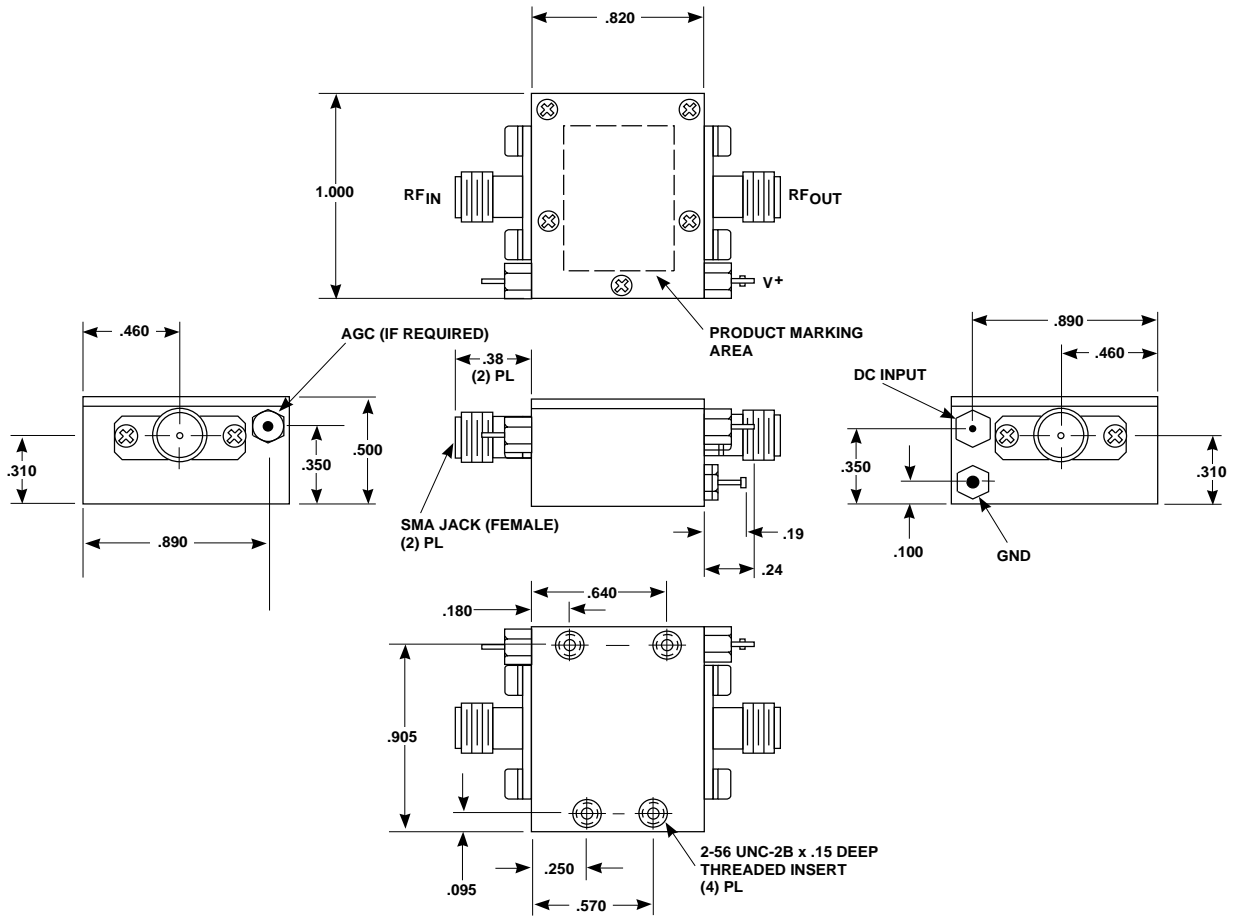

TYPICAL WEIGHT WITH CONNECTORS = 21.5 GRAMS

NOTES: 1. THE TC-1 CASE IS A NON-HERMETIC CASE.
2. THE ONLY CONNECTOR OPTION AVAILABLE FOR THE TC-1 CASE IS THE -1, SMA FEMALE CONNECTORS AT BOTH INPUT AND OUTPUT PORTS.

NOTES (UNLESS OTHERWISE SPECIFIED):
1. DIMENSIONS ARE SPECIFIED IN INCHES
2. TOLERANCES: xx ±.02
xxx ±.010

Contact Teledyne Microwave Solutions:
650-691-9800
650-962-6845 fax

Check for updates:
www.teledynemicrowave.com