



FEATURES:

- RoHSCompliant
- 4 Pin SIP Package
- Ultra MiniaturePackage
- High Efficiency up to 84%
- Operating Temperature -40°C to +85°C
- Input / Output Isolation 1000 and 3000VDC
- Pin Compatible With Multiple Manufacturers

Models Single Output



Model	Input Voltage (V)	Output Voltage (V)	Output Current Max (mA)	Capacitive Load, Max (µF)	Input Current Full No Load (mA)	Isolation (VDC)	Efficiency (%)
AM2S-0503SZ	4.5-5.5	3.3	400	220	487 35	1000	71
AM2S-0505SZ	4.5-5.5	5	400	220	487 35	1000	77
AM2S-0507SZ	4.5-5.5	7.2	270	220	152 35	1000	77
AM2S-0509SZ	4.5-5.5	9	220	220	213 35	1000	80
AM2S-0512SZ	4.5-5.5	12	160	220	208 35	1000	82
AM2S-0515SZ	4.5-5.5	15	130	220	203 35	1000	82
AM2S-0518SZ	4.5-5.5	18	110	220	198 35	1000	82
AM2S-0524SZ	4.5-5.5	24	80	220	198 35	1000	82
AM2S-1203SZ	10.8-13.2	3.3	400	220	198 20	1000	72
AM2S-1205SZ	10.8-13.2	5	400	220	203 20	1000	78
AM2S-1207SZ	10.8-13.2	7.2	270	220	120 20	1000	80
AM2S-1209SZ	10.8-13.2	9	220	220	170 20	1000	82
AM2S-1212SZ	10.8-13.2	12	160	220	166 20	1000	84
AM2S-1215SZ	10.8-13.2	15	130	220	162 20	1000	84
AM2S-1218SZ	10.8-13.2	18	110	220	158 20	1000	84
AM2S-1224SZ	10.8-13.2	24	80	220	158 25	1000	82
AM2S-2403SZ	21.6-26.4	3.3	400	220	158 18	1000	73
AM2S-2405SZ	21.6-26.4	5	400	220	162 18	1000	78
AM2S-2407SZ	21.6-26.4	7.2	270	220	74 18	1000	80
AM2S-2409SZ	21.6-26.4	9	220	220	104 18	1000	82
AM2S-2412SZ	21.6-26.4	12	160	220	104 18	1000	84
AM2S-2415SZ	21.6-26.4	15	130	220	99 18	1000	84
AM2S-2418SZ	21.6-26.4	18	110	220	99 18	1000	84
AM2S-2424SZ	21.6-26.4	24	80	220	99 18	1000	82
AM2S-4803SZ	43.2-52.8	3.3	400	220	99 10	1000	74
AM2S-4805SZ	43.2-52.8	5	400	220	99 10	1000	80
AM2S-4807SZ	43.2-52.8	7.2	270	220	38 10	1000	80
AM2S-4809SZ	43.2-52.8	9	220	220	53 10	1000	84
AM2S-4812SZ	43.2-52.8	12	160	220	52 10	1000	84
AM2S-4815SZ	43.2-52.8	15	130	220	51 10	1000	84
AM2S-4818SZ	43.2-52.8	18	110	220	52 10	1000	84
AM2S-4824SZ	43.2-52.8	24	80	220	51 10	1000	84
AM2S-0503SH30Z	4.5-5.5	3.3	400	220	487 35	3000	71
AM2S-0505SH30Z	4.5-5.5	5	400	220	487 35	3000	77
AM2S-0507SH30Z	4.5-5.5	7.2	270	220	152 35	3000	77
AM2S-0509SH30Z	4.5-5.5	9	220	220	213 35	3000	80
AM2S-0512SH30Z	4.5-5.5	12	160	220	208 35	3000	82
AM2S-0515SH30Z	4.5-5.5	15	130	220	203 35	3000	82
AM2S-0518SH30Z	4.5-5.5	18	110	220	198 35	3000	82
AM2S-0524SH30Z	4.5-5.5	24	80	220	198 35	3000	82
AM2S-1203SH30Z	10.8-13.2	3.3	400	220	198 20	3000	72
AM2S-1205SH30Z	10.8-13.2	5	400	220	203 20	3000	78
AM2S-1207SH30Z	10.8-13.2	7.2	270	220	120 20	3000	80
AM2S-1209SH30Z	10.8-13.2	9	220	220	170 20	3000	82
AM2S-1212SH30Z	10.8-13.2	12	160	220	166 20	3000	84

Models
Single Output (continued)

Model	Input Voltage (V)	Output Voltage (V)	Output Current Max (mA)	Capacitive Load, Max (µF)	Input Current Full No Load (mA)		Isolation (VDC)	Efficiency (%)
AM2S-1215SH30Z	10.8-13.2	15	130	220	162	20	3000	84
AM2S-1218SH30Z	10.8-13.2	18	110	220	158	20	3000	84
AM2S-1224SH30Z	10.8-13.2	24	80	220	158	25	3000	82
AM2S-2403SH30Z	21.6-26.4	3.3	400	220	158	18	3000	73
AM2S-2405SH30Z	21.6-26.4	5	400	220	162	18	3000	78
AM2S-2407SH30Z	21.6-26.4	7.2	270	220	74	18	3000	80
AM2S-2409SH30Z	21.6-26.4	9	220	220	104	18	3000	82
AM2S-2412SH30Z	21.6-26.4	12	160	220	104	18	3000	84
AM2S-2415SH30Z	21.6-26.4	15	130	220	99	18	3000	84
AM2S-2418SH30Z	21.6-26.4	18	110	220	99	18	3000	84
AM2S-2424SH30Z	21.6-26.4	24	80	220	99	18	3000	82
AM2S-4803SH30Z	43.2-52.8	3.3	400	220	99	10	3000	74
AM2S-4805SH30Z	43.2-52.8	5	400	220	99	10	3000	80
AM2S-4807SH30Z	43.2-52.8	7.2	270	220	38	10	3000	80
AM2S-4809SH30Z	43.2-52.8	9	220	220	53	10	3000	84
AM2S-4812SH30Z	43.2-52.8	12	160	220	52	10	3000	84
AM2S-4815SH30Z	43.2-52.8	15	130	220	51	10	3000	84
AM2S-4818SH30Z	43.2-52.8	18	110	220	52	10	3000	84
AM2S-4824SH30Z	43.2-52.8	24	80	220	51	10	3000	84

Input Specifications

Parameters	Nominal	Typical	Maximum	Units
Voltage range	5	4.5-5.5	-0.7 - 7	VDC
	12	10.8-13.2	-0.7 - 15	
	24	21.6-25.4	-0.7 - 28	
	48	43.2-52.8	-0.7 - 54	
Filter	Capacitor			
Turn on Transient Process Time			25	ms
Start-up time		200		ms
Absolute Maximum Rating	5 Vin	0-7		VDC
	12 Vin	0-15		
	24 Vin	0-28		
	48 Vin	0-54		
Peak Input Voltage time		100		ms

Isolation Specifications

Parameters	Conditions	Typical	Rated	Units
Tested I/O voltage	60 sec		1000 or 3000	VDC
Resistance		> 1000		MOhm
Capacitance		60		pF

Output Specifications

Parameters	Conditions	Typical	Maximum	Units
Voltage Accuracy		±3		%
Short Circuit Protection		Momentary (1sec)		
Over Current Protection		110% Iout max		
Line Voltage Regulation (Single)	For 1.0% of Vin	±1.2		%
Load Voltage Regulation (Single)	20...100% load	±10		%
Load Voltage Regulation (Single) 3.3V Output Model	20...100% load	±20		%
Temperature Coefficient		±0.02		%/°C
Ripple & Noise	At 20MHz Bandwidth	150		mV p-p
Rising Time		100		ms

General Specifications

Parameters	Conditions	Typical	Maximum	Units
Switching Frequency	100% load	70		KHz
Operating Temperature			-40 to +85	°C
Storage Temperature			-40 to +125	°C
Max Case Temperature			100	°C
Cooling		Free air convection		
Humidity			95	%
Case material		Plastic UL94-V0		
Weight		1.8		g
Dimensions(L x W x H)		0.46 x 0.29 x 0.38 inches	11.68 x 7.50 x 9.65 mm	
MTBF		>1121 000hrs(MIL-HDBK -217F, Ground Benign, t=+25°C)		

NOTE: All specifications in this datasheet are measured at an ambient temperature of 25°C, humidity<75%, nominal input voltage and at rated output load unless otherwise specified.

Safety Specifications

Parameters	
Agency Approval	CE (for 1000VDC Isolated models)
Standards	EN55022 (Radiated Emissions) class B
	EN55024 (Noise Immunity)
	IEC61000-4-2(ESD)
	IEC61000-4-3(Radiated immunity)

Pin Out Specifications

Pin	1000 and 3000VDC
1	-V Input
2	+V Input
3	-V Output
4	+V Output

Derating

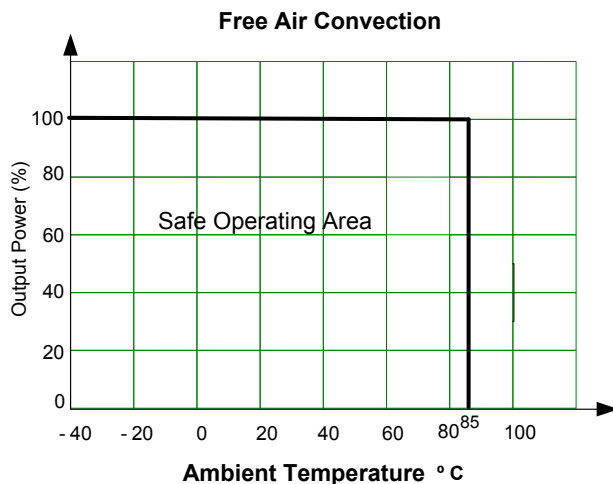

Dimensions

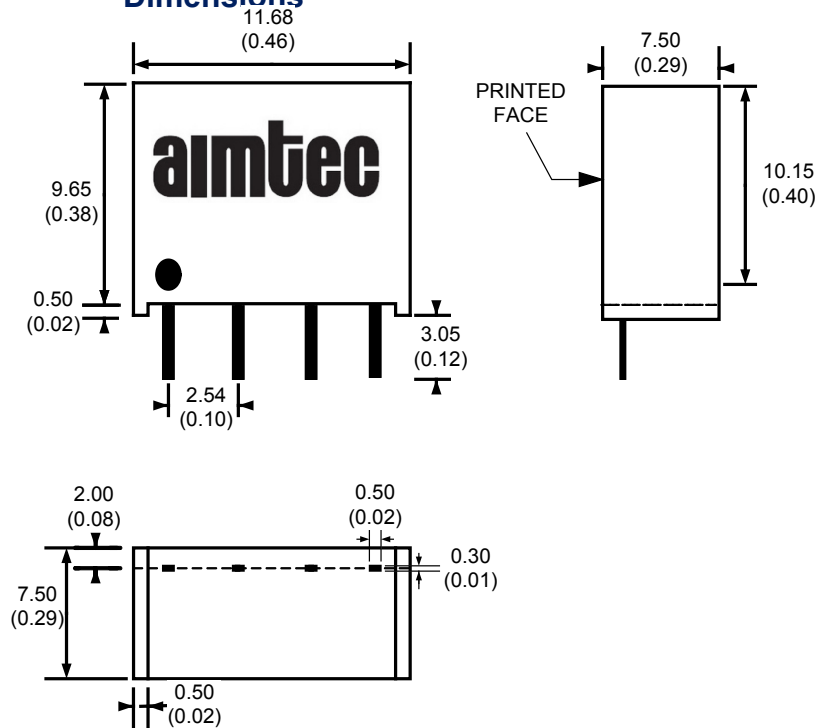

Application Circuit, & Conducted Emissions

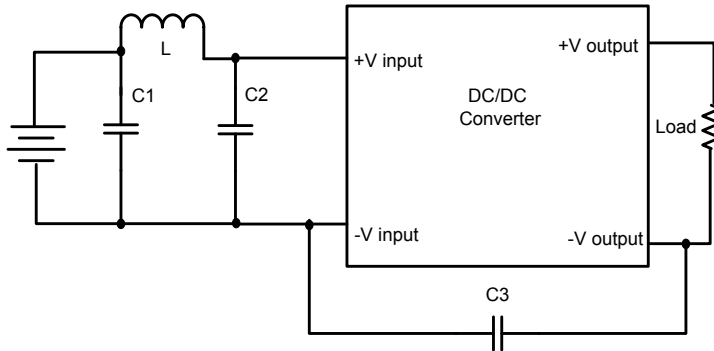

Input Voltage (VDC)	C1	L	C2	C3
5	2.2uF/100V	18uH	N/A	N/A
12	2.2uF/100V	18uH	N/A	N/A
15	2.2uF/100V	18uH	N/A	N/A
24	2.2uF/100V	18uH	2.2uF/100V	470pF/2KV
48	2.2uF/100V	18uH	2.2uF/100V	470pF/2KV

Typical Efficiency Example Charts

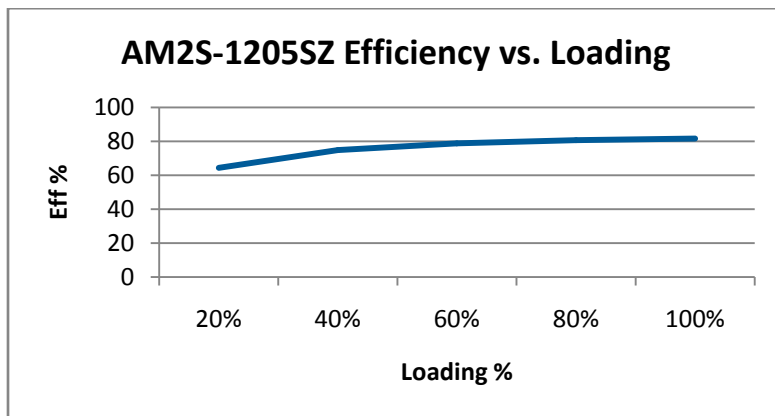
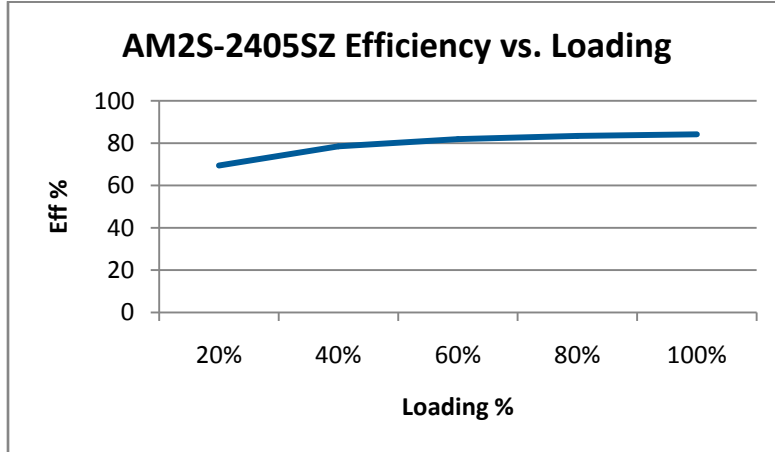

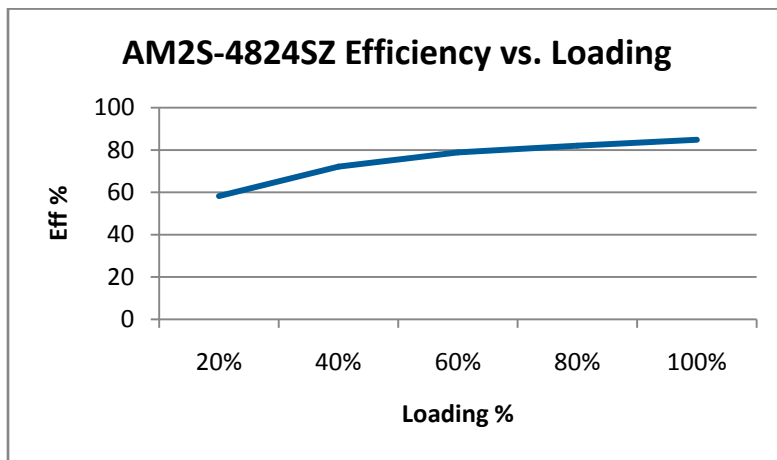
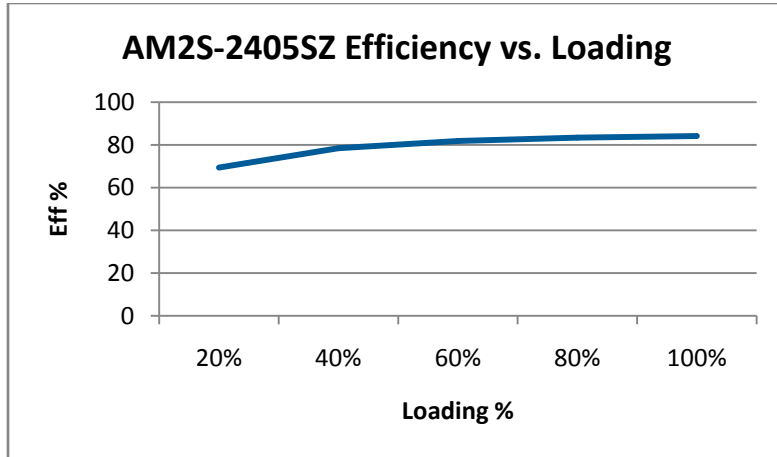

NOTE: **1.** Datasheets are updated as needed and as such, specifications are subject to change without notice. Once printed or downloaded, datasheets are no longer controlled by Aimtec; refer to www.aimtec.com for the most current product specifications. **2.** Product labels shown, including safety agency certifications on labels, may vary based on the date manufactured. **3.** Mechanical drawings and specifications are for reference only. **4.** All specifications are measured at an ambient temperature of 25°C, humidity < 75%, nominal input voltage and at rated output load unless otherwise specified. **5.** Aimtec may not have conducted destructive testing or chemical analysis on all internal components and chemicals at the time of publishing this document. CAS numbers and other limited information are considered proprietary and may not be available for release. **6.** This product is not designed for use in critical life support systems, equipment used in hazardous environments, nuclear control systems or other such applications which necessitate specific safety and regulatory standards other than the ones listed in this datasheet. **7.** Warranty is in accordance with Aimtec's standard Terms of Sale available at www.aimtec.com.