

Double Balanced Mixers B30H 3.0 to 7.0 GHz

Specifications

RF Frequency	3.0 to 7.0 GHz
LO Frequency	4.0 to 8.0 GHz
LO Power	+7 dBm typ

Transfer Characteristics

Conversion Loss	5.5 dB typ 7.0 dB max
IF Frequency	DC to 2.0 GHz
LO to RF Isolation	25 dB min 38 dB typ
LO to IF Isolation	20 dB min 35 dB typ
IP3 In	+11 dBm typ
P1dB In	+1 dBm typ



Available Package Styles

Available Package Styles

W1,X,Y,Z

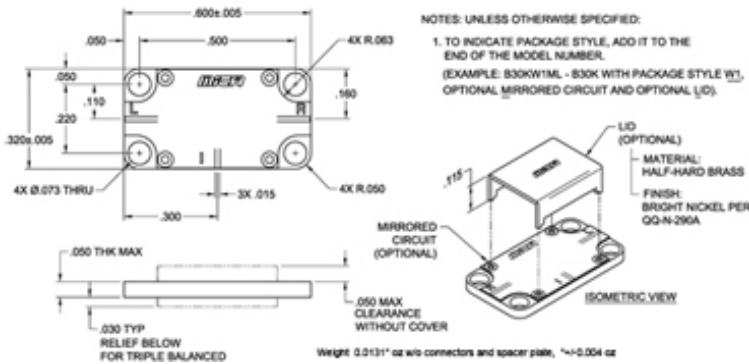

X PACKAGE

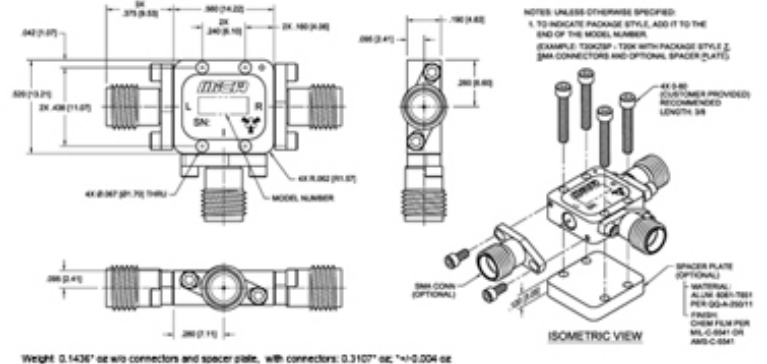
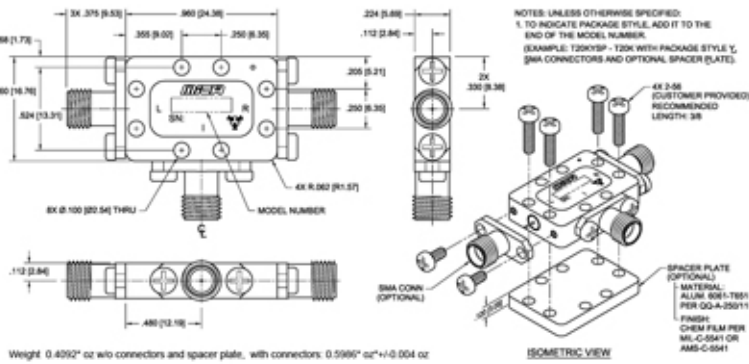
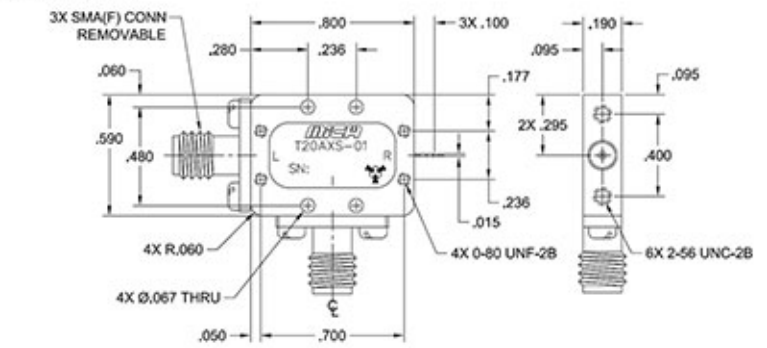

Environmental Ratings

Operating Temp -55 °C to 100 °C

Notes

Specifications subject to change without notice

Mica Microwave | Manteca, CA | 1-209-825-3977 | www.Mica-MW.com



