

SERIES: CP60H | **DESCRIPTION:** PELTIER MODULE

FEATURES

- solid state device
- high performance cooler
- precise temperature control
- quiet operation

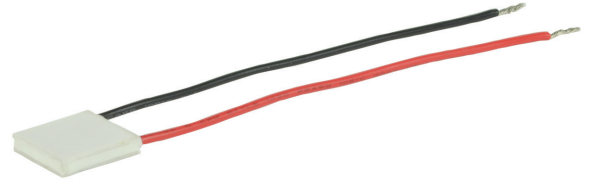

MODEL	input voltage ¹ max (Vdc)	input current ² max (A)	output Qmax ³		output ΔTmax ⁴	
			T _h =27°C (W)	T _h =50°C (W)	T _h =27°C (°C)	T _h =50°C (°C)
CP60131H	3.8	6.0	13	14.3	70	77
CP60231H	8.8	6.0	29.7	32.7	70	77
CP603315H	15.7	6.0	53.1	59.1	70	77
CP60139H	2.1	6.0	7.4	8.2	70	77
CP60239H	3.8	6.0	13.6	14.9	70	77
CP603395H	8.8	6.0	31.1	34.2	70	77
CP604395H	15.7	6.0	55.6	61.0	70	77

- Notes:
1. Maximum voltage at ΔT max and T_h=27°C
 2. Maximum current to achieve ΔT max
 3. Maximum heat absorbed at cold side occurs at I_{max}, V_{max}, and ΔT=0°C
 4. Maximum temperature difference occurs at I_{max}, V_{max}, and Q=0W (ΔT max measured in a vacuum at 1.3 Pa)

PART NUMBER KEY

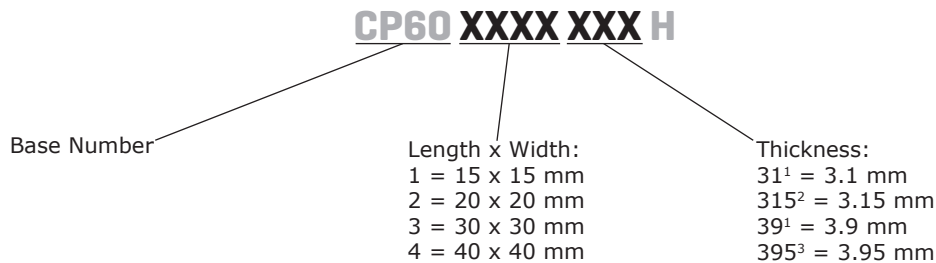

- Notes:
1. Only available in 15 x 15 and 20 x 20 mm size
 2. Only available in 30 x 30 mm size
 3. Only available in 30 x 30 and 40 x 40 mm size

SPECIFICATIONS

parameter	conditions/description	min	typ	max	units
internal resistance ¹	CP60131H	0.405	0.45	0.495	Ω
	CP60231H	0.945	1.05	1.155	Ω
	CP603315H	1.71	1.90	2.09	Ω
	CP60139H	0.27	0.30	0.33	Ω
	CP60239H	0.495	0.55	0.605	Ω
	CP603395H	1.125	1.25	1.375	Ω
	CP604395H	1.98	2.2	2.42	Ω
solder melting temperature	connection between thermoelectric pairs	235			°C
assembly compression				1	MPa
hot side plate				80	°C
RoHS	2011/65/EU				

Note: 1. Measured by AC 4-terminal method at 25°C

MECHANICAL DRAWING

units: mm

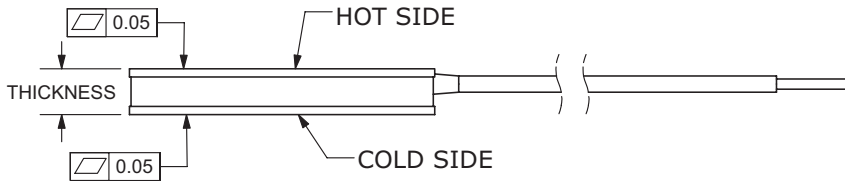

	MATERIAL	PLATING
ceramic plate	96% AL ₂ O ₃	
wire leads (3.1 & 3.15 mm models)	22 AWG	tin
wire leads (3.9 & 3.95 mm models)	20 AWG	tin
sealer	silicon rubber 703 RTV (between cold and hot side plates)	
joint cover	silicon rubber 703 RTV	
marking	P/N & S/N printed on cold side surface	

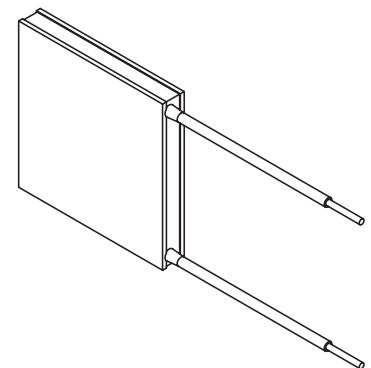
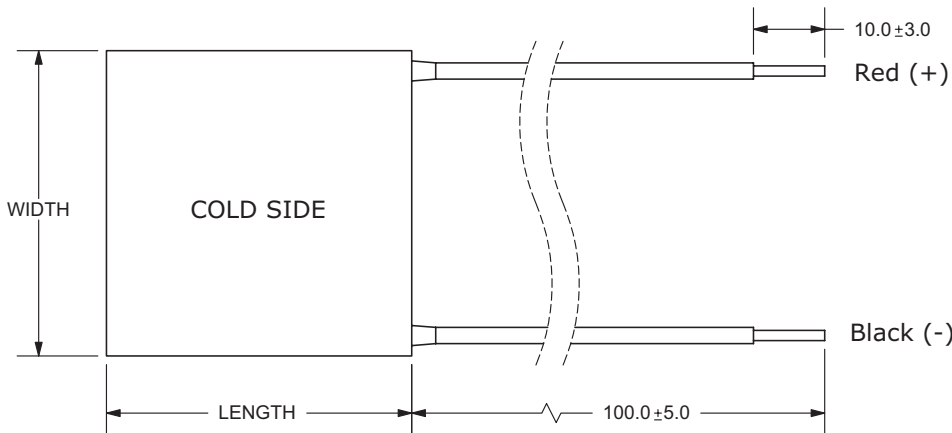

MODEL NO.	LENGTH (mm)	WIDTH (mm)	THICKNESS (mm)
CP60131H	15 ±0.3	15 ±0.3	3.1 ±0.025
CP60231H	20 ±0.3	20 ±0.3	3.1 ±0.025
CP603315H	30 ±0.3	30 ±0.3	3.15 ±0.025
CP60139H	15 ±0.3	15 ±0.3	3.9 ±0.025
CP60239H	20 ±0.3	20 ±0.3	3.9 ±0.025
CP603395H	30 ±0.3	30 ±0.3	3.95 ±0.025
CP604395H	40 ±0.3	40 ±0.3	3.95 ±0.025

CP60131H PERFORMANCE (Th=27°C)

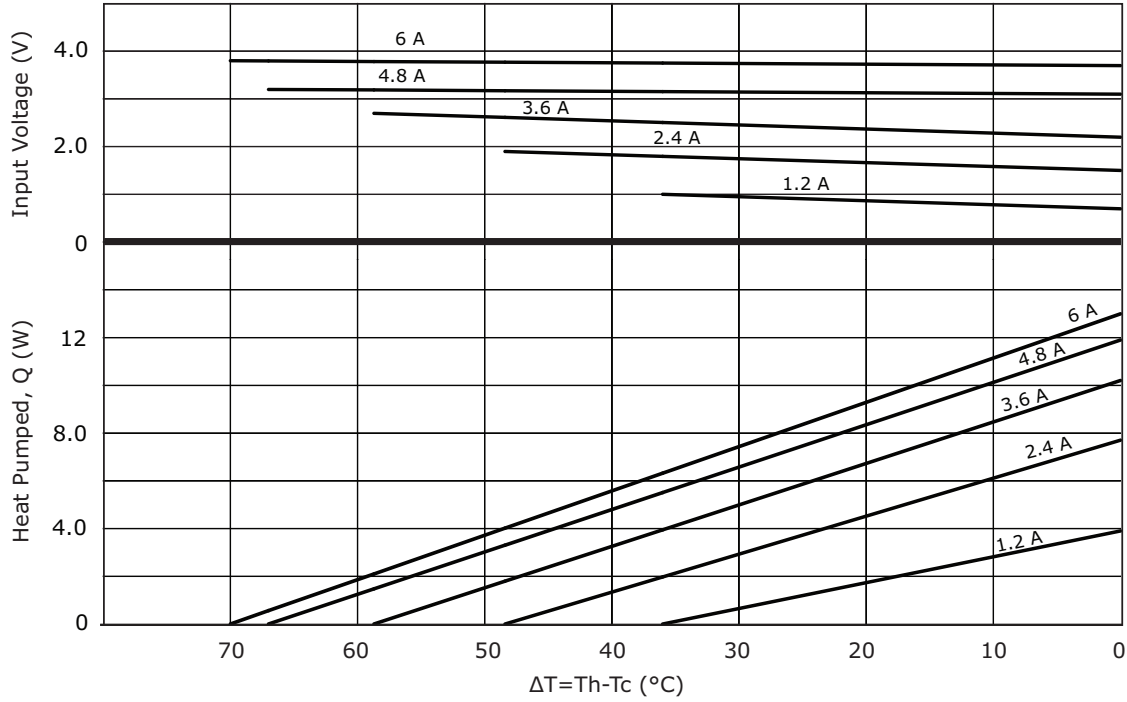

CP60131H PERFORMANCE (Th=50°C)

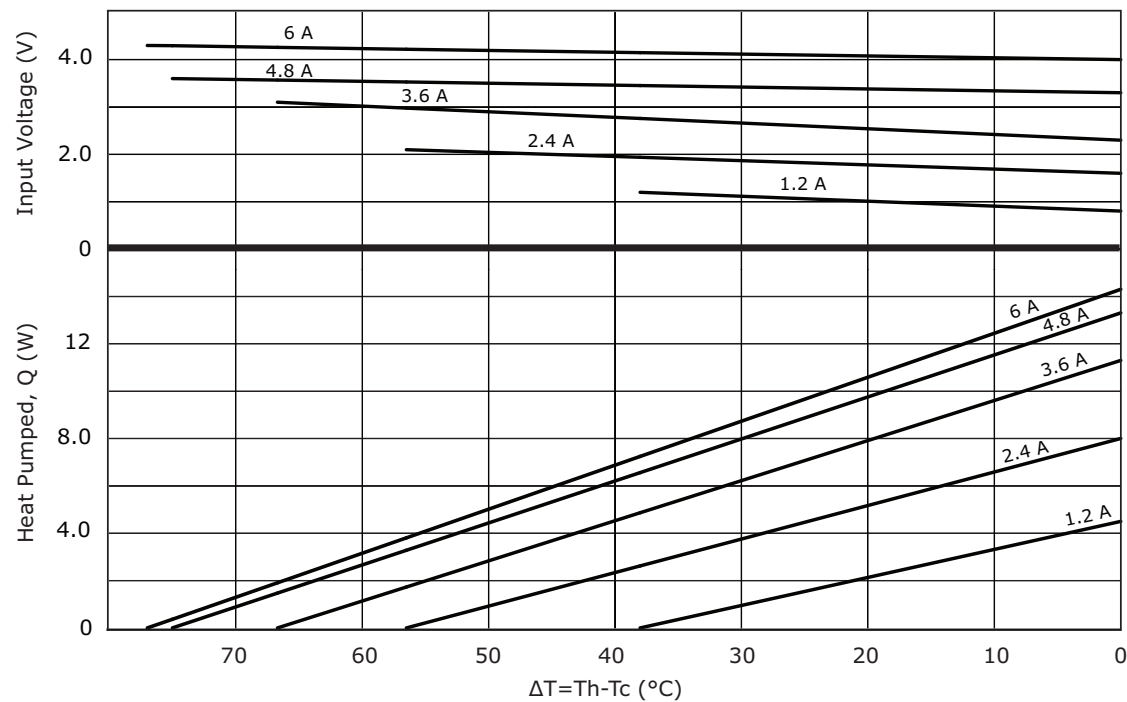

CP60231H PERFORMANCE (Th=27°C)

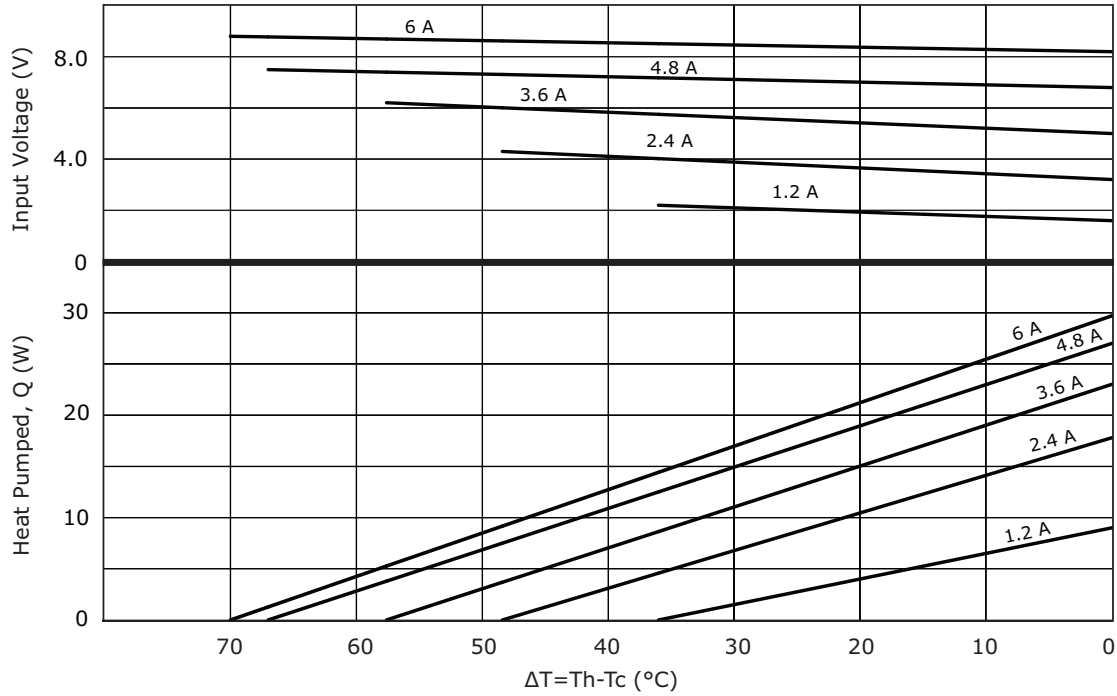

CP60231H PERFORMANCE (Th=50°C)

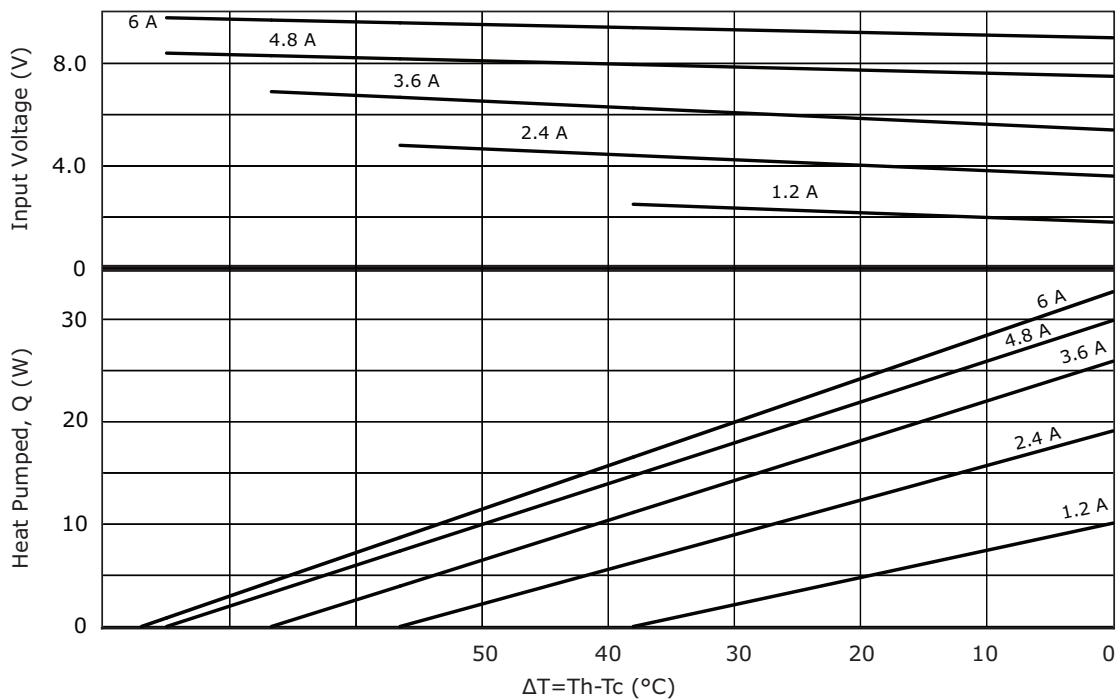

CP603315H PERFORMANCE (Th=27°C)

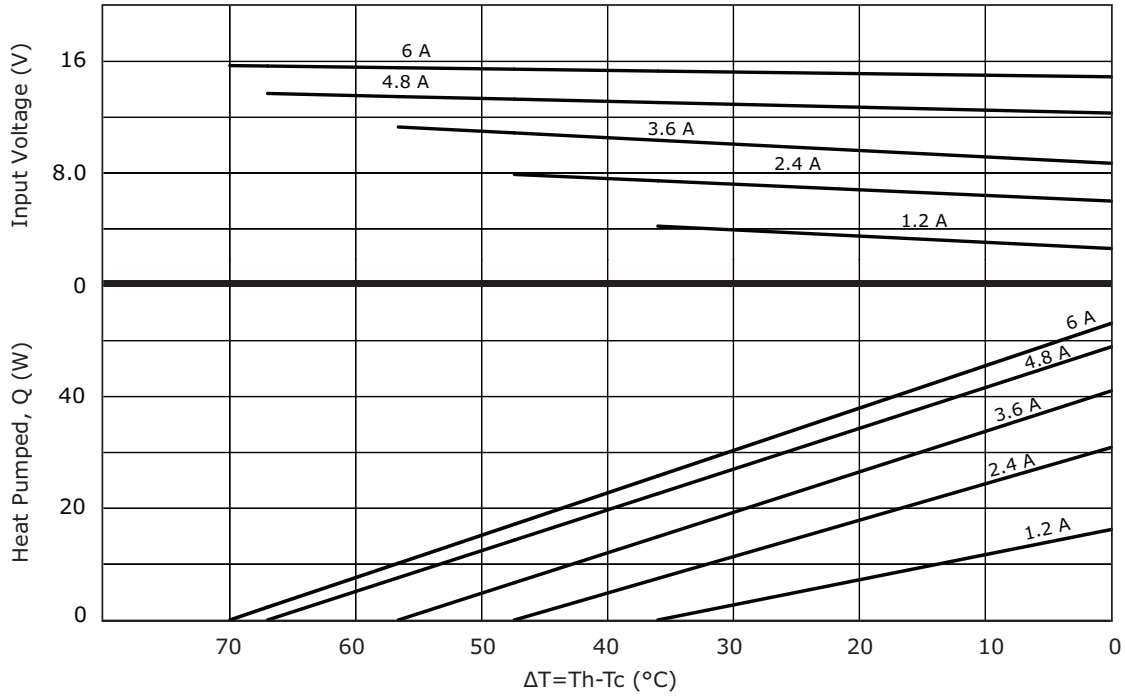

CP603315H PERFORMANCE (Th=50°C)

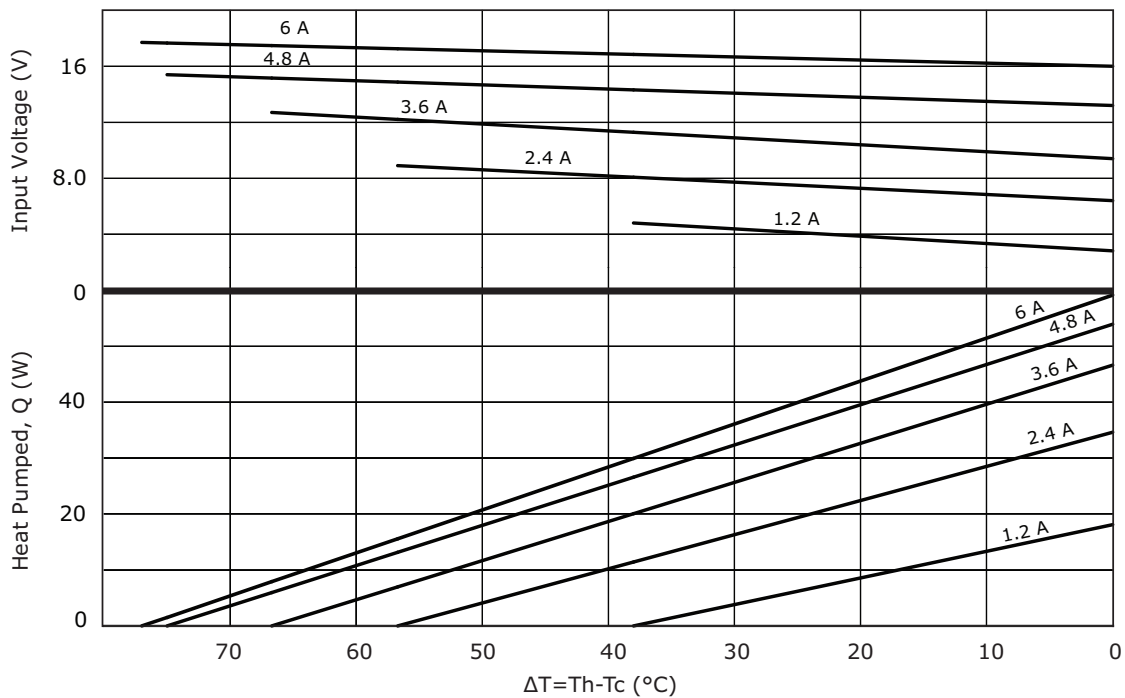

CP60139H PERFORMANCE (Th=27°C)

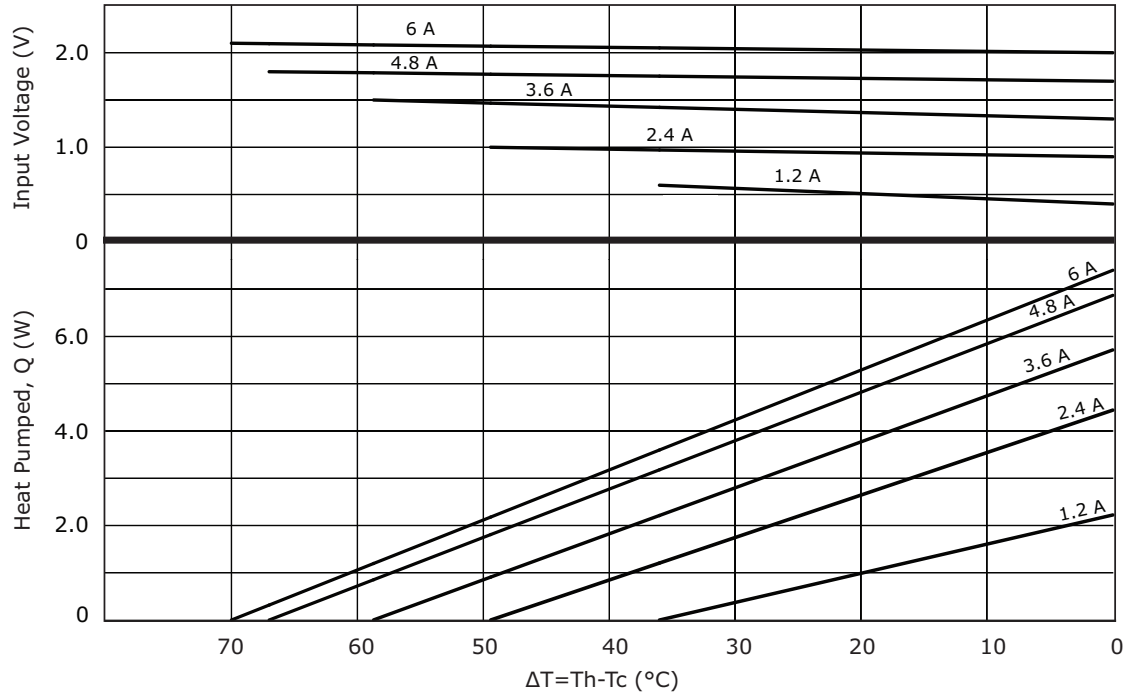

CP60139H PERFORMANCE (Th=50°C)

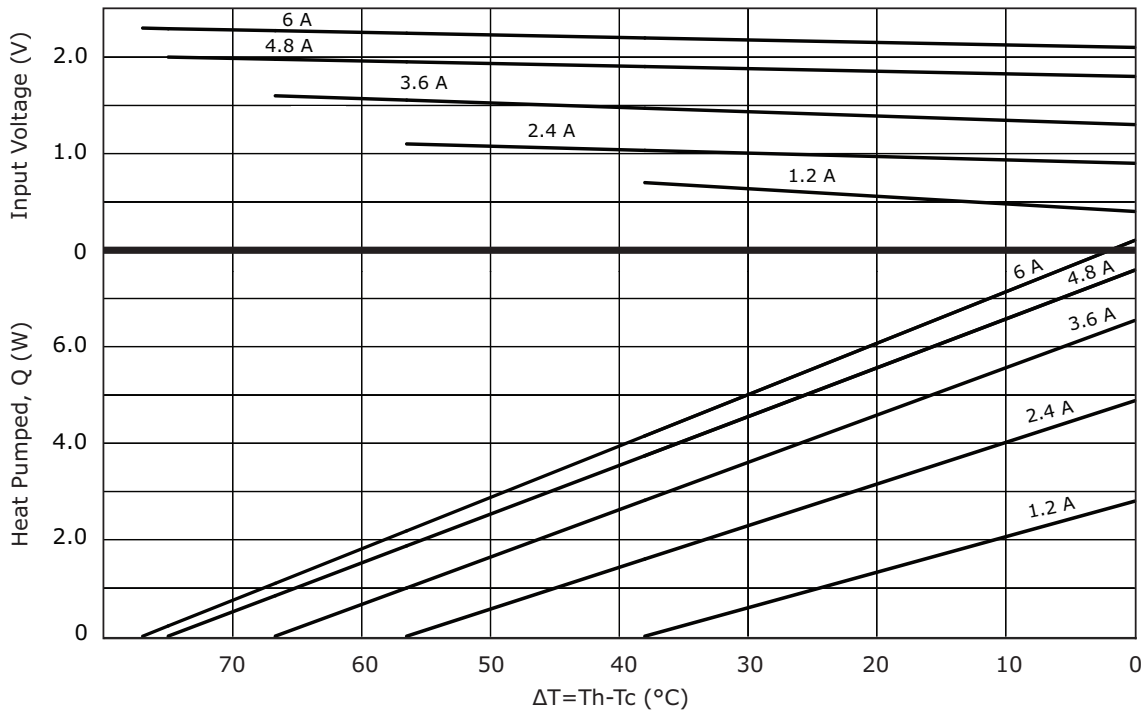

CP60239H PERFORMANCE (Th=27°C)

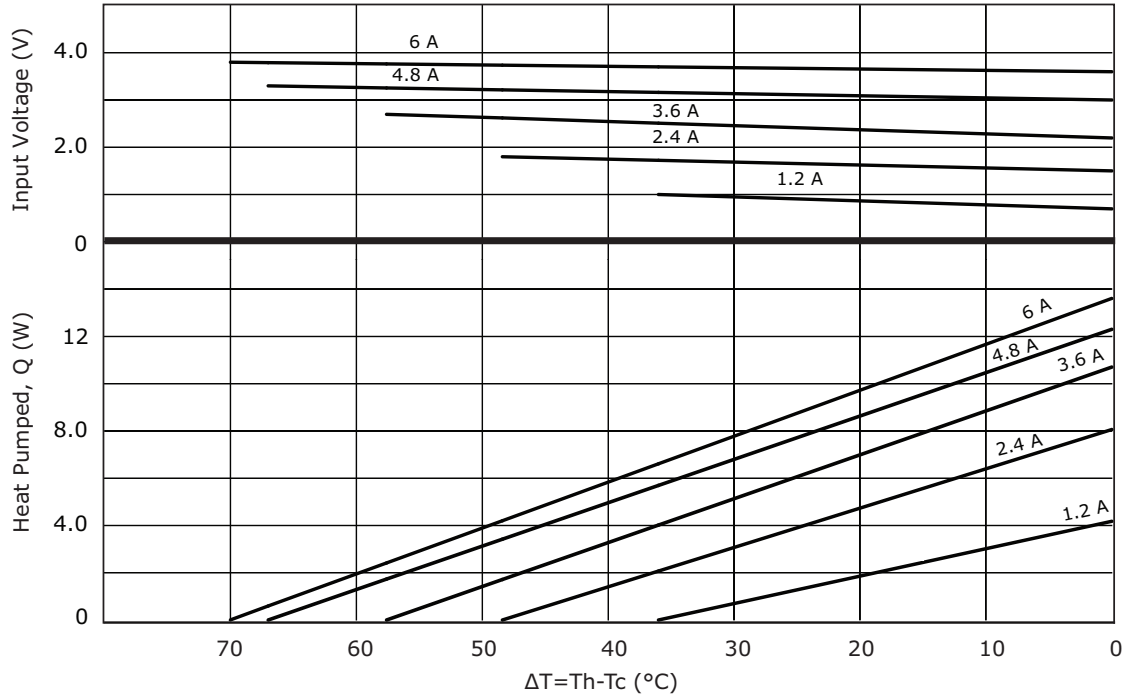

CP60239H PERFORMANCE (Th=50°C)

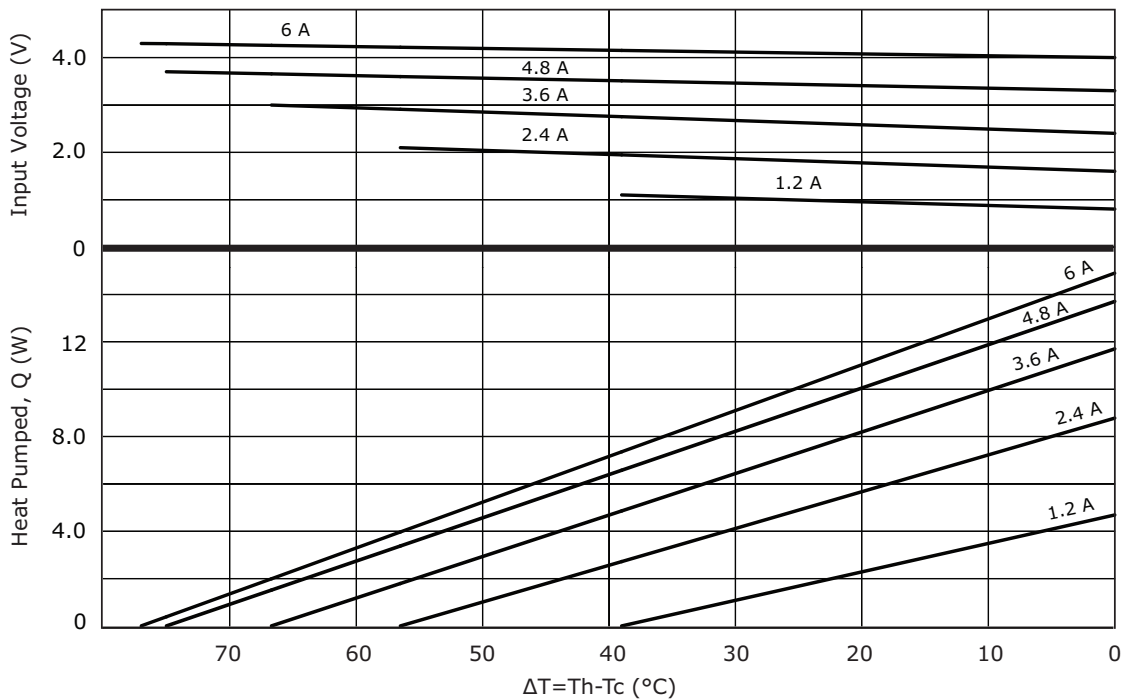

CP603395H PERFORMANCE (Th=27°C)

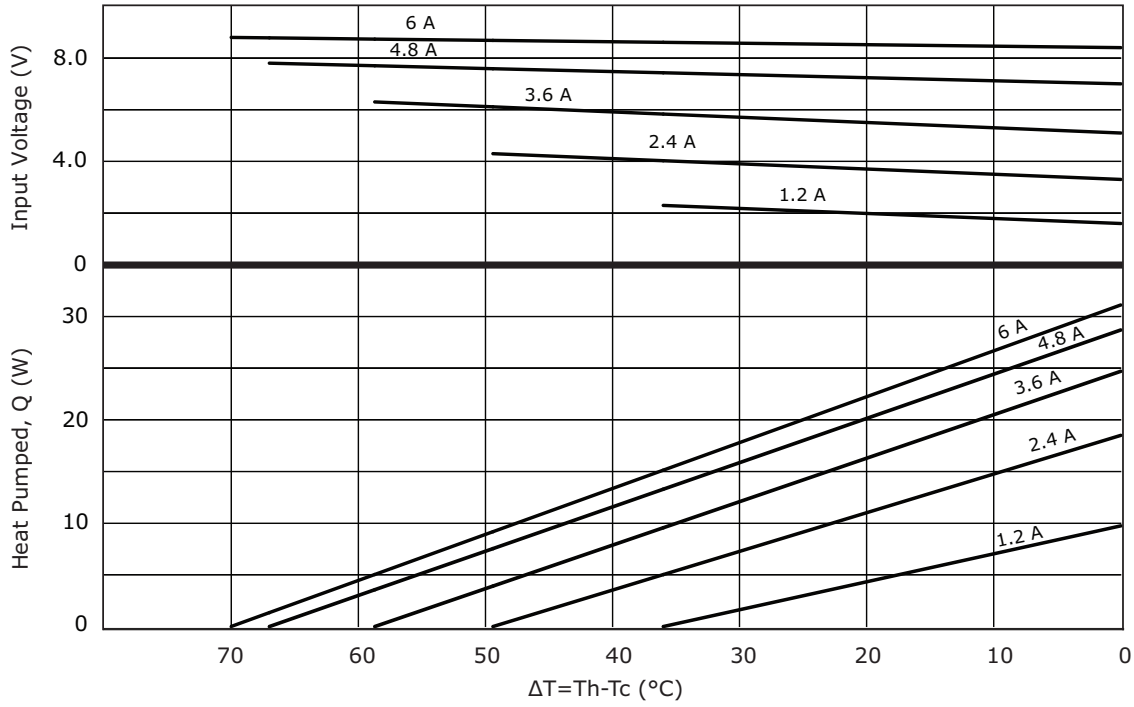

CP603395H PERFORMANCE (Th=50°C)

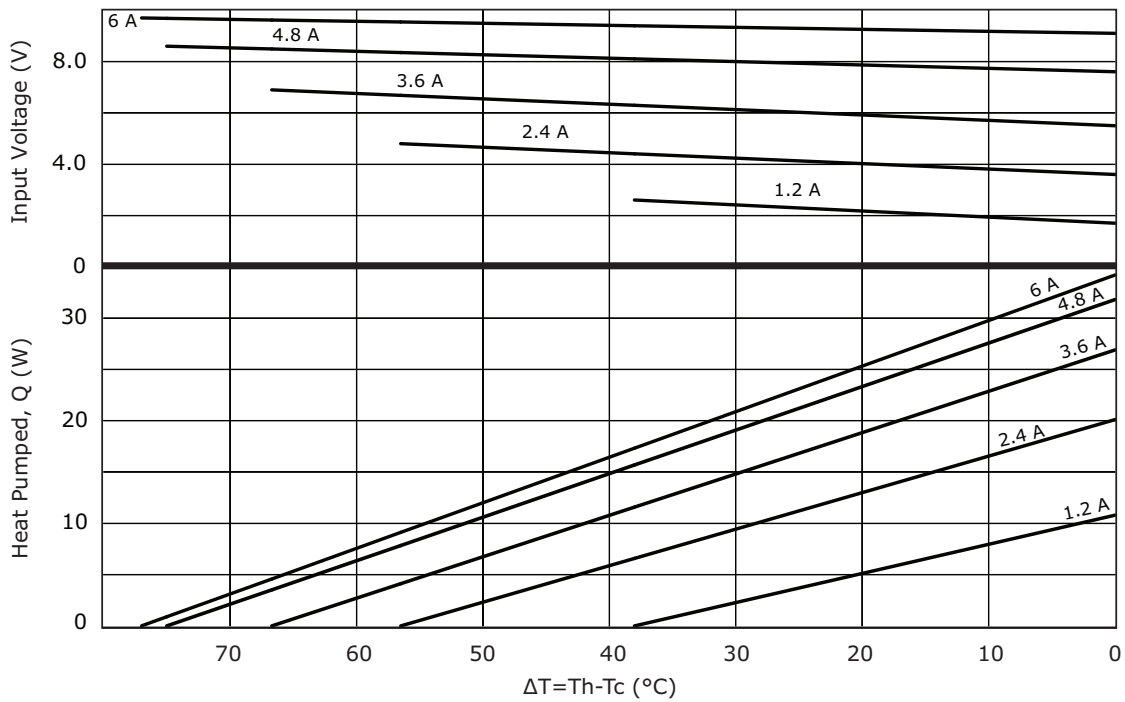

CP604395H PERFORMANCE (Th=27°C)

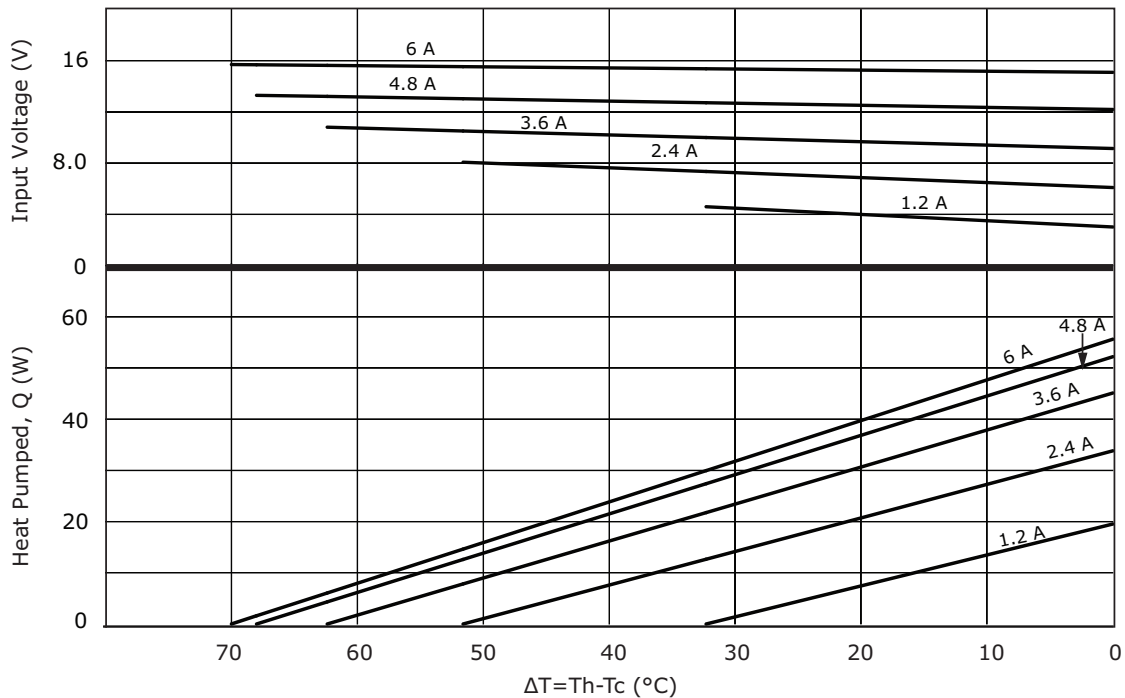

CP604395H PERFORMANCE (Th=50°C)

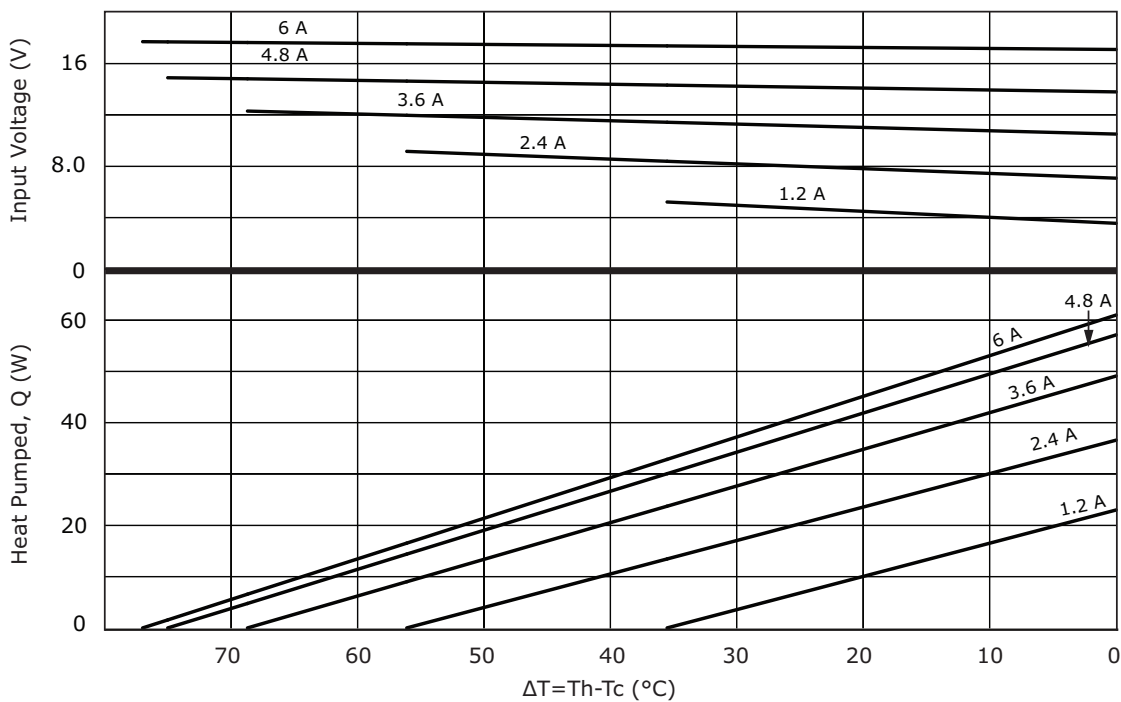

REVISION HISTORY

rev.	description	date
1.0	initial release	09/08/2016

The revision history provided is for informational purposes only and is believed to be accurate.



CUI INC[®]

Headquarters
20050 SW 112th Ave.
Tualatin, OR 97062
800.275.4899

Fax 503.612.2383
cui.com
techsupport@cui.com

CUI offers a one (1) year limited warranty. Complete warranty information is listed on our website.

CUI reserves the right to make changes to the product at any time without notice. Information provided by CUI is believed to be accurate and reliable. However, no responsibility is assumed by CUI for its use, nor for any infringements of patents or other rights of third parties which may result from its use.

CUI products are not authorized or warranted for use as critical components in equipment that requires an extremely high level of reliability. A critical component is any component of a life support device or system whose failure to perform can be reasonably expected to cause the failure of the life support device or system, or to affect its safety or effectiveness.