

# NGTG15N120FL2WG

## IGBT - Field Stop II

This Insulated Gate Bipolar Transistor (IGBT) features a robust and cost effective Field Stop II Trench construction, and provides superior performance in demanding switching applications, offering both low on state voltage and minimal switching loss. The IGBT is well suited for UPS and solar applications.

### Features

- Extremely Efficient Trench with Field Stop Technology
- $T_{Jmax} = 175^{\circ}C$
- Optimized for High Speed Switching
- 10  $\mu s$  Short Circuit Capability
- These are Pb-Free Devices

### Typical Applications

- Solar Inverter
- Uninterruptible Power Inverter Supplies (UPS)
- Welding

### ABSOLUTE MAXIMUM RATINGS

Rating	Symbol	Value	Unit
Collector-emitter voltage	$V_{CES}$	1200	V
Collector current @ $T_C = 25^{\circ}C$ @ $T_C = 100^{\circ}C$	$I_C$	30 15	A
Pulsed collector current, $T_{pulse}$ limited by $T_{Jmax}$	$I_{CM}$	60	A
Gate-emitter voltage Transient gate-emitter voltage ( $T_{pulse} = 5 \mu s, D < 0.10$ )	$V_{GE}$	$\pm 20$ $\pm 30$	V
Power Dissipation @ $T_C = 25^{\circ}C$ @ $T_C = 100^{\circ}C$	$P_D$	294 147	W
Short Circuit Withstand Time $V_{GE} = 15 V, V_{CE} = 500 V, T_J \leq 150^{\circ}C$	$T_{SC}$	10	$\mu s$
Operating junction temperature range	$T_J$	-55 to +175	$^{\circ}C$
Storage temperature range	$T_{stg}$	-55 to +175	$^{\circ}C$
Lead temperature for soldering, 1/8" from case for 5 seconds	$T_{SLD}$	260	$^{\circ}C$

Stresses exceeding those listed in the Maximum Ratings table may damage the device. If any of these limits are exceeded, device functionality should not be assumed, damage may occur and reliability may be affected.



**ON Semiconductor**<sup>®</sup>

<http://onsemi.com>

**15 A, 1200 V**  
 **$V_{CEsat} = 2.0 V$**   
 **$E_{off} = 0.37 mJ$**

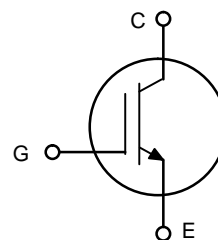

### MARKING DIAGRAM



- A = Assembly Location
- Y = Year
- WW = Work Week
- G = Pb-Free Package

### ORDERING INFORMATION

Device	Package	Shipping
NGTG15N120FL2WG	TO-247 (Pb-Free)	30 Units / Rail

# NGTG15N120FL2WG

## THERMAL CHARACTERISTICS

Rating	Symbol	Value	Unit
Thermal resistance junction-to-case, for IGBT	$R_{\theta JC}$	0.51	°C/W
Thermal resistance junction-to-ambient	$R_{\theta JA}$	40	°C/W

## ELECTRICAL CHARACTERISTICS ( $T_J = 25^\circ\text{C}$ unless otherwise specified)

Parameter	Test Conditions	Symbol	Min	Typ	Max	Unit
-----------	-----------------	--------	-----	-----	-----	------

### STATIC CHARACTERISTIC

Collector-emitter breakdown voltage, gate-emitter short-circuited	$V_{GE} = 0\text{ V}, I_C = 500\ \mu\text{A}$	$V_{(BR)CES}$	1200	–	–	V
Collector-emitter saturation voltage	$V_{GE} = 15\text{ V}, I_C = 15\text{ A}$ $V_{GE} = 15\text{ V}, I_C = 15\text{ A}, T_J = 175^\circ\text{C}$	$V_{CEsat}$	–	2.00 2.40	2.40 –	V
Gate-emitter threshold voltage	$V_{GE} = V_{CE}, I_C = 400\ \mu\text{A}$	$V_{GE(th)}$	4.5	5.65	6.5	V
Collector-emitter cut-off current, gate-emitter short-circuited	$V_{GE} = 0\text{ V}, V_{CE} = 1200\text{ V}$ $V_{GE} = 0\text{ V}, V_{CE} = 1200\text{ V}, T_J = 175^\circ\text{C}$	$I_{CES}$	–	–	0.4 4.0	mA
Gate leakage current, collector-emitter short-circuited	$V_{GE} = 20\text{ V}, V_{CE} = 0\text{ V}$	$I_{GES}$	–	–	200	nA

Input capacitance	$V_{CE} = 20\text{ V}, V_{GE} = 0\text{ V}, f = 1\text{ MHz}$	$C_{ies}$	–	2640	–	pF
Output capacitance		$C_{oes}$	–	88	–	
Reverse transfer capacitance		$C_{res}$	–	50	–	
Gate charge total	$V_{CE} = 600\text{ V}, I_C = 15\text{ A}, V_{GE} = 15\text{ V}$	$Q_g$	–	109	–	nC
Gate to emitter charge		$Q_{ge}$	–	23	–	
Gate to collector charge		$Q_{gc}$	–	51	–	

### SWITCHING CHARACTERISTIC, INDUCTIVE LOAD

Turn-on delay time	$T_J = 25^\circ\text{C}$ $V_{CC} = 600\text{ V}, I_C = 15\text{ A}$ $R_g = 10\ \Omega$ $V_{GE} = 0\text{ V}/15\text{ V}^*$	$t_{d(on)}$	–	64	–	ns	
Rise time		$t_r$	–	104	–		
Turn-off delay time		$t_{d(off)}$	–	128	–		
Fall time			$t_f$	–	173	–	mJ
Turn-on switching loss		$E_{on}$	–	1.20	–		
Turn-off switching loss		$E_{off}$	–	0.37	–		
Total switching loss		$E_{ts}$	–	1.57	–		
Turn-on delay time	$T_J = 150^\circ\text{C}$ $V_{CC} = 600\text{ V}, I_C = 15\text{ A}$ $R_g = 10\ \Omega$ $V_{GE} = 0\text{ V}/15\text{ V}^*$	$t_{d(on)}$	–	62	–	ns	
Rise time		$t_r$	–	126	–		
Turn-off delay time		$t_{d(off)}$	–	134	–		
Fall time			$t_f$	–	262	–	mJ
Turn-on switching loss		$E_{on}$	–	1.45	–		
Turn-off switching loss		$E_{off}$	–	0.76	–		
Total switching loss		$E_{ts}$	–	2.21	–		

Product parametric performance is indicated in the Electrical Characteristics for the listed test conditions, unless otherwise noted. Product performance may not be indicated by the Electrical Characteristics if operated under different conditions.

\*Includes diode reverse recovery loss using NGTB15N120FL2WG.

# NGTG15N120FL2WG

## TYPICAL CHARACTERISTICS

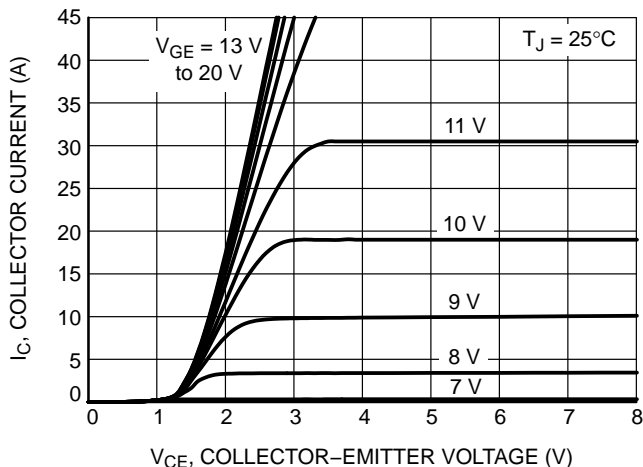

Figure 1. Output Characteristics

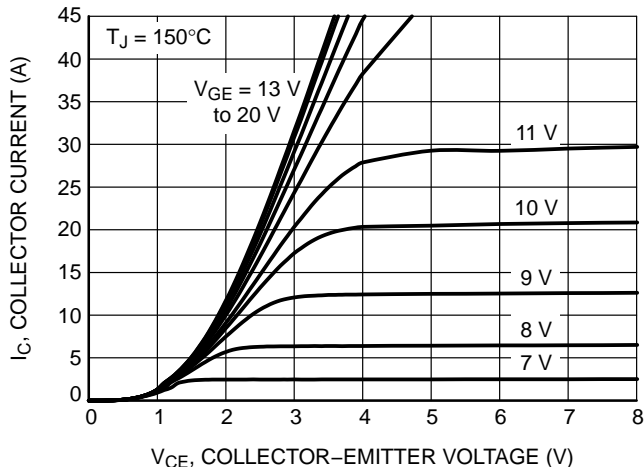

Figure 2. Output Characteristics

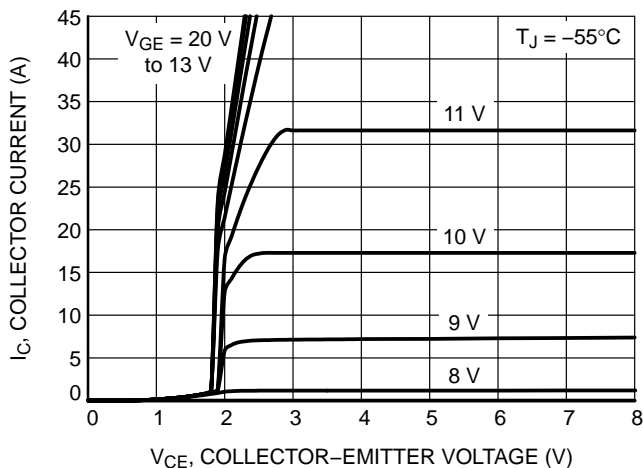

Figure 3. Output Characteristics

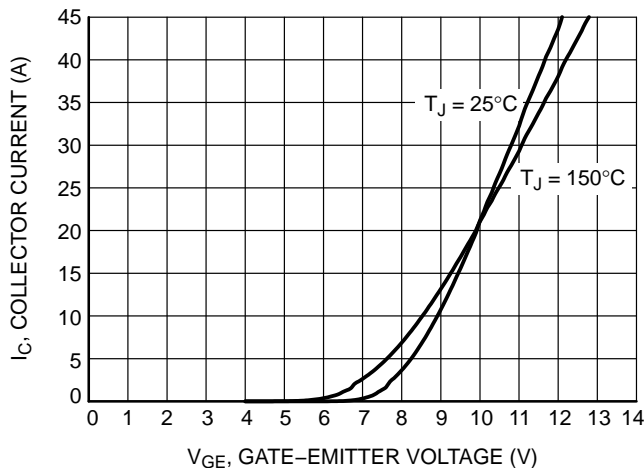

Figure 4. Typical Transfer Characteristics

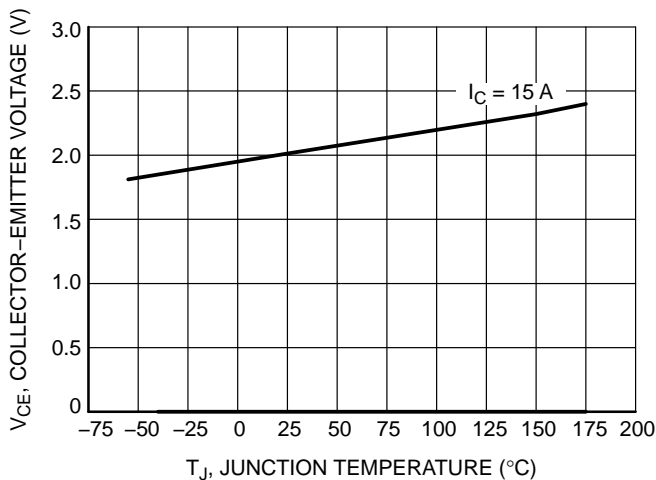

Figure 5.  $V_{CE(sat)}$  vs.  $T_J$

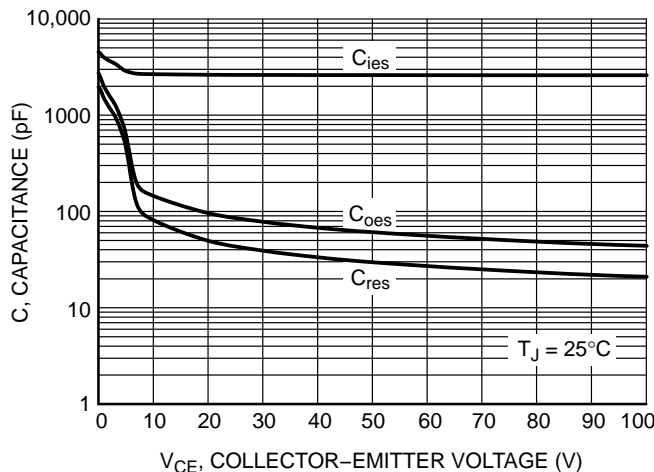

Figure 6. Typical Capacitance

# NGTG15N120FL2WG

## TYPICAL CHARACTERISTICS

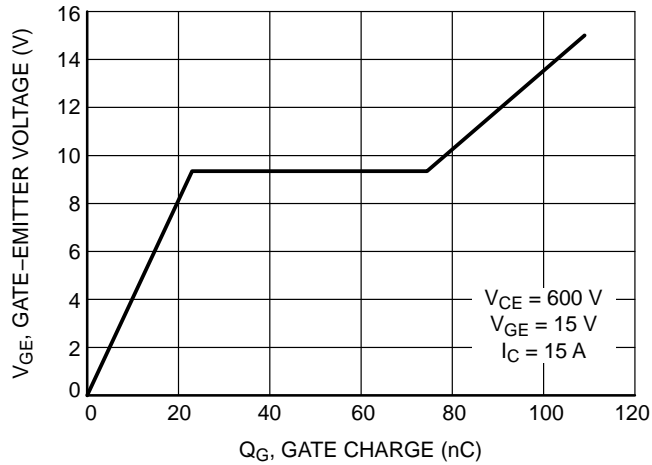

Figure 7. Typical Gate Charge

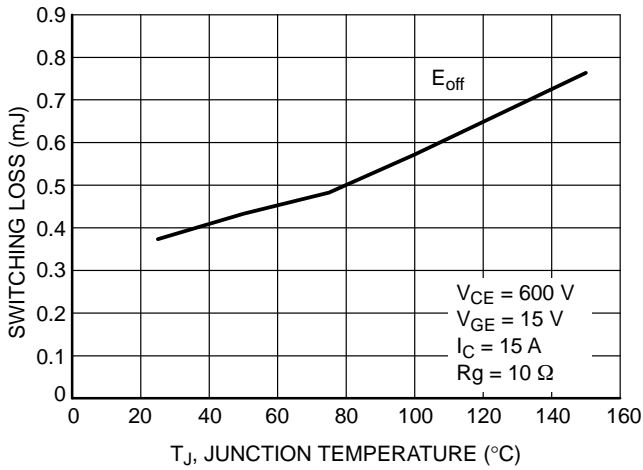

Figure 8. Switching Loss vs. Temperature

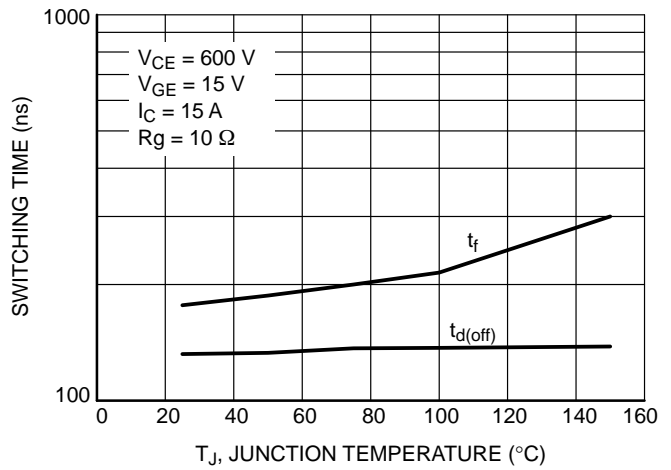

Figure 9. Switching Time vs. Temperature

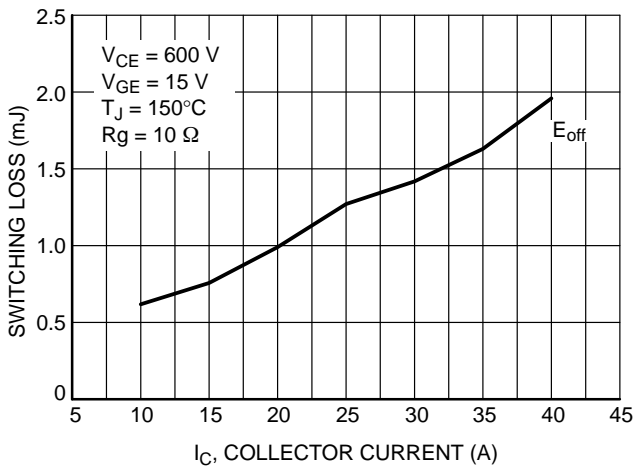

Figure 10. Switching Loss vs.  $I_C$

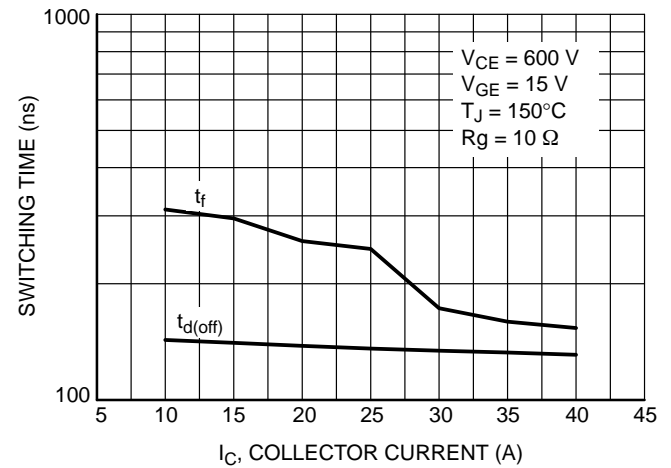

Figure 11. Switching Time vs.  $I_C$

# NGTG15N120FL2WG

## TYPICAL CHARACTERISTICS

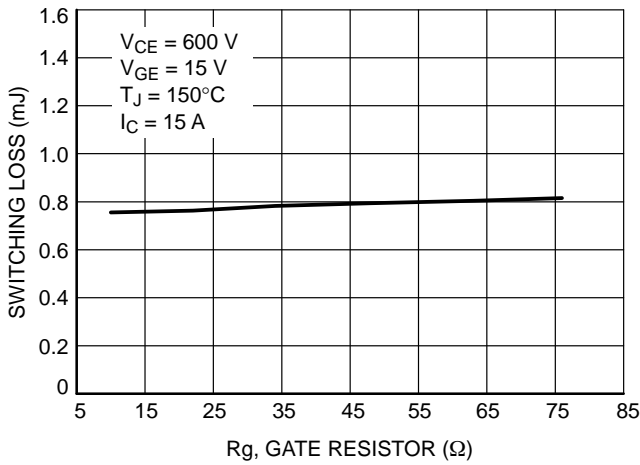

Figure 12. Switching Loss vs. Rg

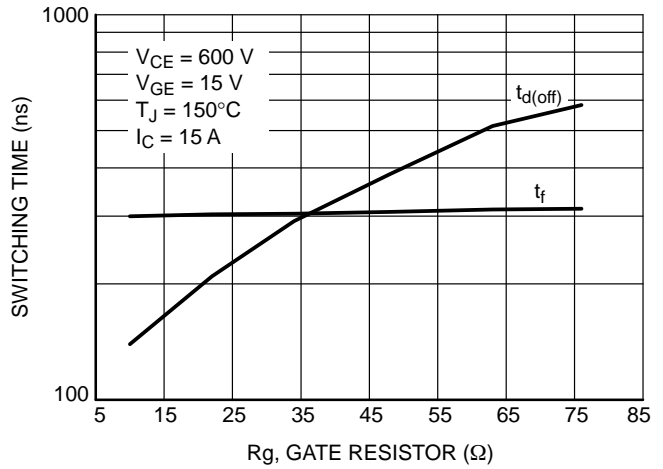

Figure 13. Switching Time vs. Rg

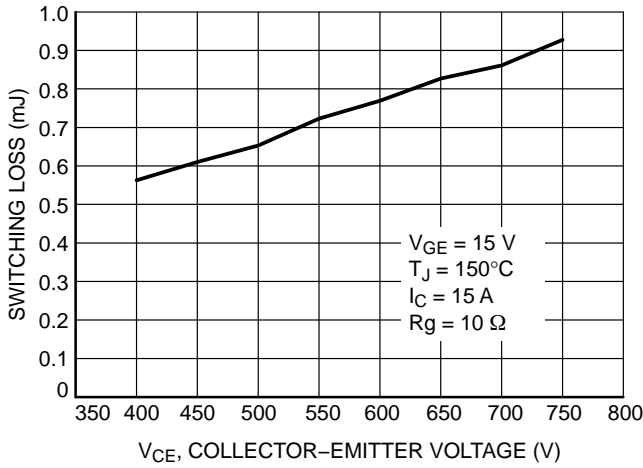

Figure 14. Switching Loss vs.  $V_{CE}$

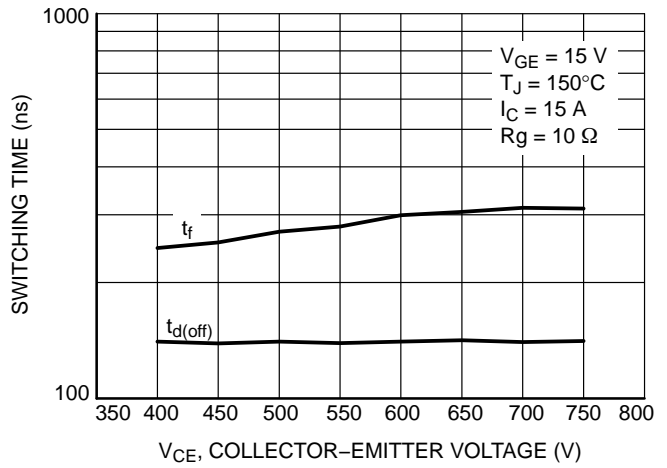

Figure 15. Switching Time vs.  $V_{CE}$

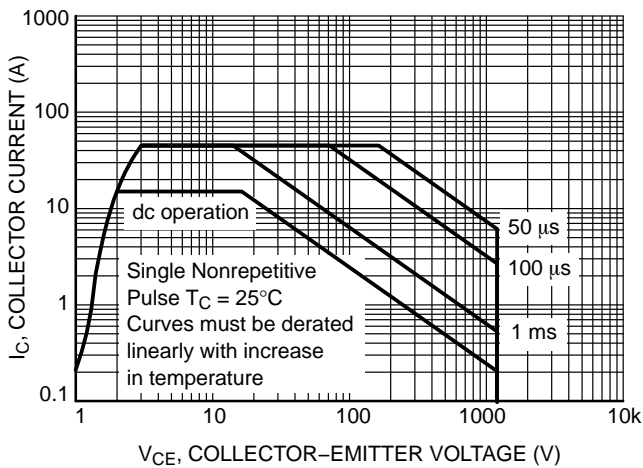

Figure 16. Safe Operating Area

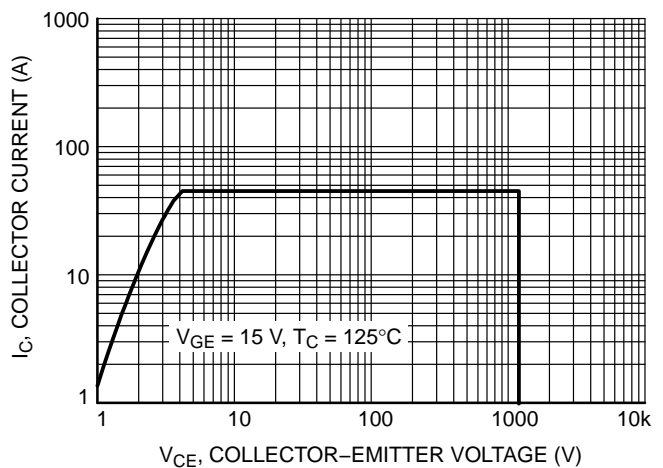

Figure 17. Reverse Bias Safe Operating Area

# NGTG15N120FL2WG

## TYPICAL CHARACTERISTICS

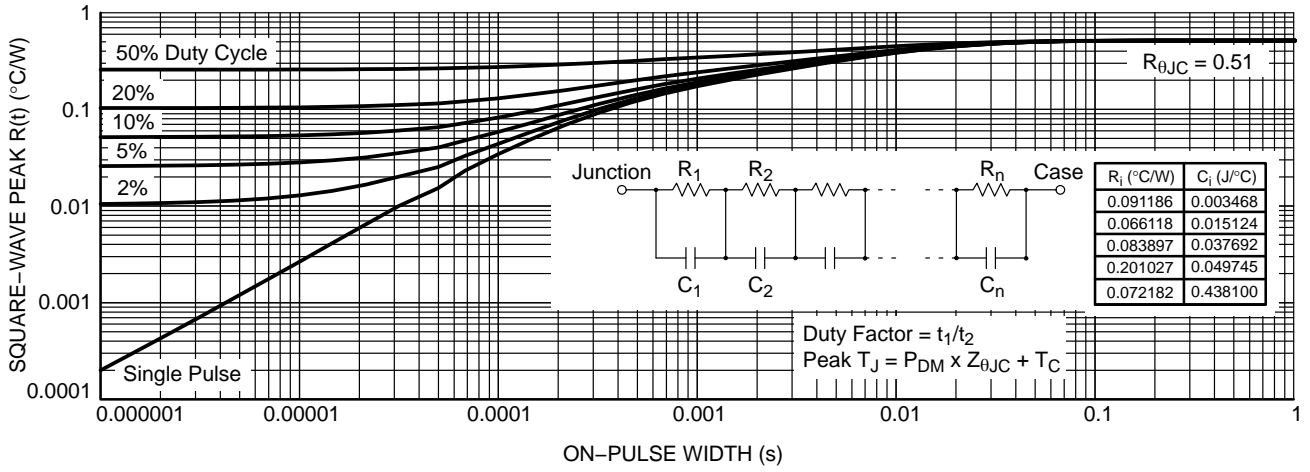

Figure 18. IGBT Die Self-heating Square-wave Duty Cycle Transient Thermal Response

# NGTG15N120FL2WG

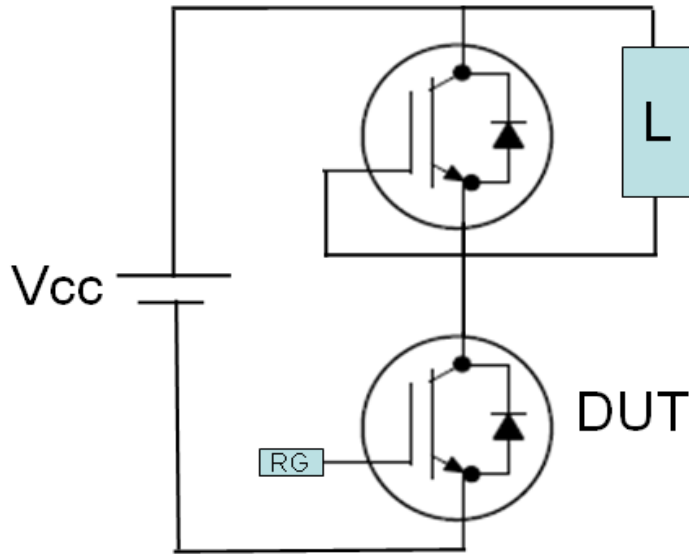
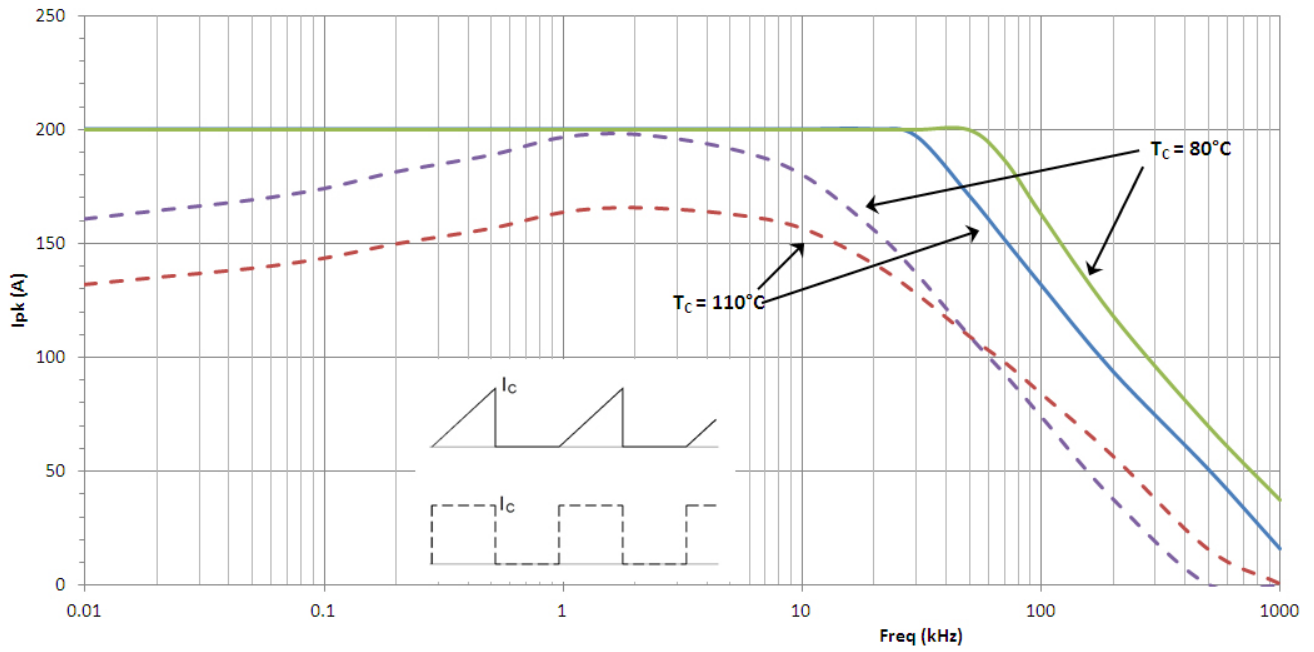

Figure 19. Test Circuit for Switching Characteristics

# NGTG15N120FL2WG



Figure 20. Definition of Turn On Waveform



# NGTG15N120FL2WG

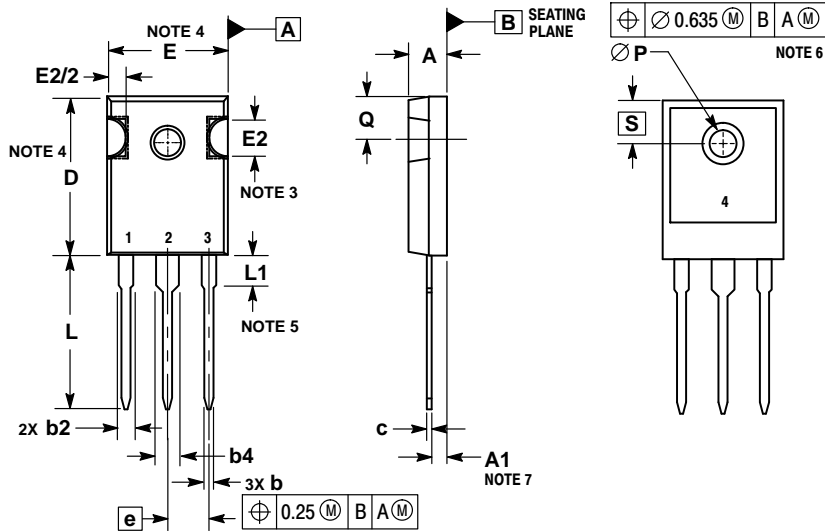

Figure 21. Definition of Turn Off Waveform

# NGTG15N120FL2WG

## PACKAGE DIMENSIONS

TO-247  
CASE 340AL  
ISSUE A



NOTES:

1. DIMENSIONING AND TOLERANCING PER ASME Y14.5M, 1994.
2. CONTROLLING DIMENSION: MILLIMETERS.
3. SLOT REQUIRED, NOTCH MAY BE ROUNDED.
4. DIMENSIONS D AND E DO NOT INCLUDE MOLD FLASH. MOLD FLASH SHALL NOT EXCEED 0.13 PER SIDE. THESE DIMENSIONS ARE MEASURED AT THE OUTERMOST EXTREME OF THE PLASTIC BODY.
5. LEAD FINISH IS UNCONTROLLED IN THE REGION DEFINED BY L1.
6.  $\varnothing P$  SHALL HAVE A MAXIMUM DRAFT ANGLE OF 1.5° TO THE TOP OF THE PART WITH A MAXIMUM DIAMETER OF 3.91.
7. DIMENSION A1 TO BE MEASURED IN THE REGION DEFINED BY L1.

DIM	MILLIMETERS	
	MIN	MAX
A	4.70	5.30
A1	2.20	2.60
b	1.00	1.40
b2	1.65	2.35
b4	2.60	3.40
c	0.40	0.80
D	20.30	21.40
E	15.50	16.25
E2	4.32	5.49
e	5.45 BSC	
L	19.80	20.80
L1	3.50	4.50
P	3.55	3.65
Q	5.40	6.20
S	6.15 BSC	

ON Semiconductor and are registered trademarks of Semiconductor Components Industries, LLC (SCILLC). SCILLC owns the rights to a number of patents, trademarks, copyrights, trade secrets, and other intellectual property. A listing of SCILLC's product/patent coverage may be accessed at [www.onsemi.com/site/pdf/Patent-Marking.pdf](http://www.onsemi.com/site/pdf/Patent-Marking.pdf). SCILLC reserves the right to make changes without further notice to any products herein. SCILLC makes no warranty, representation or guarantee regarding the suitability of its products for any particular purpose, nor does SCILLC assume any liability arising out of the application or use of any product or circuit, and specifically disclaims any and all liability, including without limitation special, consequential or incidental damages. "Typical" parameters which may be provided in SCILLC data sheets and/or specifications can and do vary in different applications and actual performance may vary over time. All operating parameters, including "Typicals" must be validated for each customer application by customer's technical experts. SCILLC does not convey any license under its patent rights nor the rights of others. SCILLC products are not designed, intended, or authorized for use as components in systems intended for surgical implant into the body, or other applications intended to support or sustain life, or for any other application in which the failure of the SCILLC product could create a situation where personal injury or death may occur. Should Buyer purchase or use SCILLC products for any such unintended or unauthorized application, Buyer shall indemnify and hold SCILLC and its officers, employees, subsidiaries, affiliates, and distributors harmless against all claims, costs, damages, and expenses, and reasonable attorney fees arising out of, directly or indirectly, any claim of personal injury or death associated with such unintended or unauthorized use, even if such claim alleges that SCILLC was negligent regarding the design or manufacture of the part. SCILLC is an Equal Opportunity/Affirmative Action Employer. This literature is subject to all applicable copyright laws and is not for resale in any manner.

### PUBLICATION ORDERING INFORMATION

**LITERATURE FULFILLMENT:**  
Literature Distribution Center for ON Semiconductor  
P.O. Box 5163, Denver, Colorado 80217 USA  
Phone: 303-675-2175 or 800-344-3860 Toll Free USA/Canada  
Fax: 303-675-2176 or 800-344-3867 Toll Free USA/Canada  
Email: [orderlit@onsemi.com](mailto:orderlit@onsemi.com)

**N. American Technical Support:** 800-282-9855 Toll Free  
USA/Canada  
**Europe, Middle East and Africa Technical Support:**  
Phone: 421 33 790 2910  
**Japan Customer Focus Center**  
Phone: 81-3-5817-1050

**ON Semiconductor Website:** [www.onsemi.com](http://www.onsemi.com)  
**Order Literature:** <http://www.onsemi.com/orderlit>  
For additional information, please contact your local Sales Representative