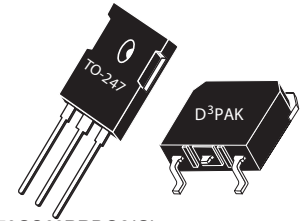

Thunderbolt® High Speed NPT IGBT with Anti-Parallel 'DQ' Diode

The Thunderbolt HS™ series is based on thin wafer non-punch through (NPT) technology similar to the Thunderbolt® series, but trades higher $V_{CE(ON)}$ for significantly lower turn-on energy E_{off} . The low switching losses enable operation at switching frequencies over 100kHz, approaching power MOSFET performance but lower cost.

An extremely tight parameter distribution combined with a positive $V_{CE(ON)}$ temperature coefficient make it easy to parallel Thunderbolts HS™ IGBT's. Controlled slew rates result in very good noise and oscillation immunity and low EMI. The short circuit duration rating of 10 μ s make these IGBT's suitable for motor drive and inverter applications. Reliability is further enhanced by avalanche energy ruggedness. Combi versions are packaged with a high speed, soft recovery DQ series diode.

 APT50GS60BRDQ2(G)
 APT50GS60SRDQ2(G)

Single die
 IGBT with
 separate DQ
 diode die

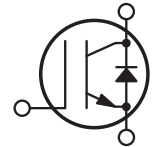

Features

- Fast Switching with low EMI
- Very Low E_{OFF} for Maximum Efficiency
- Short circuit rated
- Low Gate Charge
- Tight parameter distribution
- Easy paralleling
- RoHS Compliant 

Typical Applications

- ZVS Phase Shifted and other Full Bridge
- Half Bridge
- High Power PFC Boost
- Welding
- Induction heating
- High Frequency SMPS

Absolute Maximum Ratings

Symbol	Parameter	Rating	Unit	
I_{C1}	Continuous Collector Current $T_C = @ 25^\circ C$	93	A	
I_{C1}	Continuous Collector Current $T_C = @ 100^\circ C$	50		
I_{CM}	Pulsed Collector Current ^①	195		
V_{GE}	Gate-Emitter Voltage	$\pm 30V$	V	
SSOA	Switching Safe Operating Area	195		
E_{AS}	Single Pulse Avalanche Energy	20	mJ	
t_{SC}	Short Circuit Withstand Time ^③	10	μ s	
I_F	Diode Continuous Forward Current	$T_C = 25^\circ C$	90	A
		$T_C = 100^\circ C$	55	
I_{FRM}	Diode Max. Repetitive Forward Current	195		

Thermal and Mechanical Characteristics

Symbol	Parameter	Min	Typ	Max	Unit
P_D	Total Power Dissipation $T_C = @ 25^\circ C$			415	W
$R_{\theta JC}$	Junction to Case Thermal Resistance	IGBT		0.30	$^\circ C/W$
		Diode		0.67	
$R_{\theta CS}$	Case to Sink Thermal Resistance, Flat Greased Surface		0.11		
T_J, T_{STG}	Operating and Storage Junction Temperature Range	-55		150	$^\circ C$
T_L	Soldering Temperature for 10 Seconds (1.6mm from case)			300	
W_T	Package Weight		0.22		oz
			5.9		g
Torque	Mounting Torque (TO-247), 6-32 M3 Screw			10	in·lbf
				1.1	N·m

 **CAUTION:** These Devices are Sensitive to Electrostatic Discharge. Proper Handling Procedures Should be Followed.

Static Characteristics
T_J = 25°C unless otherwise specified
APT50GS60B_SRDQ2(G)

Symbol	Parameter	Test Conditions	Min	Typ	Max	Unit
V _{BR(CES)}	Collector-Emitter Breakdown Voltage	V _{GE} = 0V, I _C = 2.0mA	600			V
ΔV _{BR(CES)} /ΔT _J	Breakdown Voltage Temperature Coeff	Reference to 25°C, I _C = 2.0mA		0.60		V/°C
V _{CE(ON)}	Collector-Emitter On Voltage ^③	V _{GE} = 15V I _C = 50A	T _J = 25°C	2.8	3.15	V
			T _J = 125°C	3.25		
V _{EC}	Diode Forward Voltage ^③	I _C = 50A	T _J = 25°C	2.15		
			T _J = 125°C	1.8		
V _{GE(th)}	Gate-Emitter Threshold Voltage	V _{GE} = V _{CE} , I _C = 1mA	3	4	5	mV/°C
ΔV _{GE(th)} /ΔT _J	Threshold Voltage Temp Coeff			6.7		
I _{CES}	Zero Gate Voltage Collector Current	V _{CE} = 600V, V _{GE} = 0V	T _J = 25°C		50	μA
			T _J = 125°C		1000	
I _{GES}	Gate-Emitter Leakage Current	V _{GE} = ±20V			±100	nA

Dynamic Characteristics
T_J = 25°C unless otherwise specified

Symbol	Parameter	Test Conditions	Min	Typ	Max	Unit
g _{fs}	Forward Transconductance	V _{CE} = 50V, I _C = 50A		31		S
C _{ies}	Input Capacitance	V _{GE} = 0V, V _{CE} = 25V f = 1MHz		2635		pF
C _{oes}	Output Capacitance			240		
C _{res}	Reverse Transfer Capacitance			145		
C _{o(cr)}	Reverse Transfer Capacitance Charge Related ^④	V _{GE} = 0V V _{CE} = 0 to 400V		115		
C _{o(er)}	Reverse Transfer Capacitance Current Related ^⑤			85		
Q _g	Total Gate Charge	V _{GE} = 0 to 15V I _C = 50A, V _{CE} = 300V		235		nC
Q _{ge}	Gate-Emitter Charge			18		
G _{gc}	Gate-Collector Charge			100		
t _{d(on)}	Turn-On Delay Time	Inductive Switching IGBT and Diode: T _J = 25°C, V _{CC} = 400V, I _C = 50A R _G = 4.7Ω ^⑥ , V _{GG} = 15V		16		ns
t _r	Rise Time			33		
t _{d(off)}	Turn-Off Delay Time			225		
t _f	Fall Time			37		
E _{on1}	Turn-On Switching Energy ^⑦			TBD		
E _{on2}	Turn-On Switching Energy ^⑧	Inductive Switching IGBT and Diode: T _J = 125°C, V _{CC} = 400V, I _C = 50A R _G = 4.7Ω ^⑥ , V _{GG} = 15V		1.2		mJ
E _{off}	Turn-Off Switching Energy ^⑨			0.755		
t _{d(on)}	Turn-On Delay Time			33		
t _r	Rise Time	Inductive Switching IGBT and Diode: T _J = 125°C, V _{CC} = 400V, I _C = 50A R _G = 4.7Ω ^⑥ , V _{GG} = 15V		33		ns
t _{d(off)}	Turn-Off Delay Time			250		
t _f	Fall Time			23		
E _{on1}	Turn-On Switching Energy ^⑦			TBD		
E _{on2}	Turn-On Switching Energy ^⑧			1.7		
E _{off}	Turn-Off Switching Energy ^⑨		0.950			
t _{rr}	Diode Reverse Recovery Time	I _F = 50A V _R = 400V di _F /dt = 200A/μs		25		ns
Q _{rr}	Diode Reverse Recovery Charge			35		nC
I _{rrm}	Peak Reverse Recovery Current			3		A

TYPICAL PERFORMANCE CURVES

APT50GS60B_SRDQ2(G)

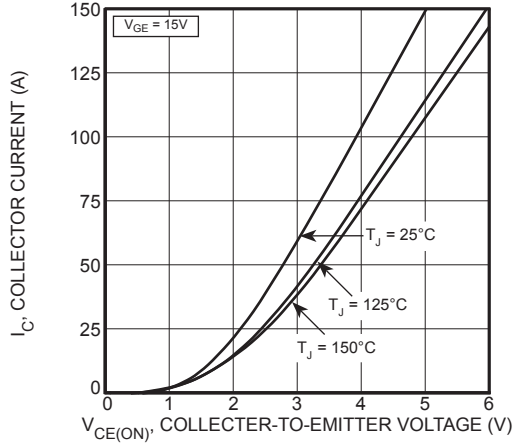

FIGURE 1, Output Characteristics

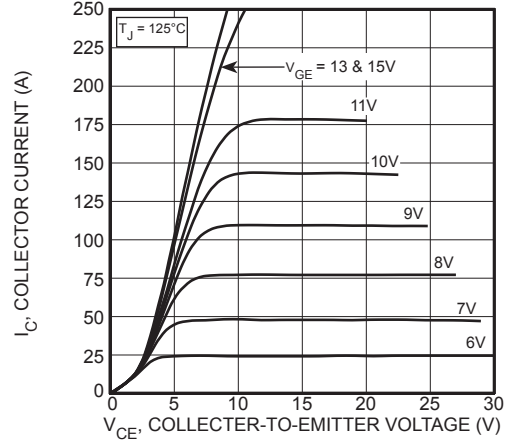

FIGURE 2, Output Characteristics

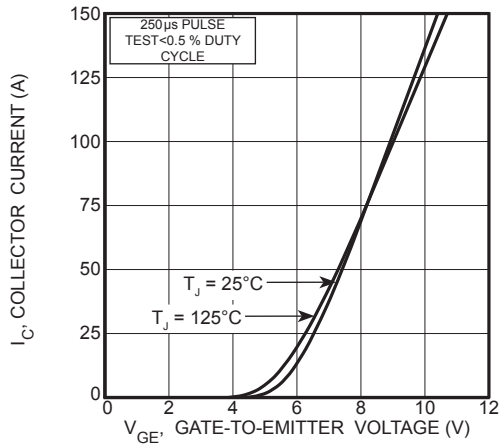

FIGURE 3, Transfer Characteristics

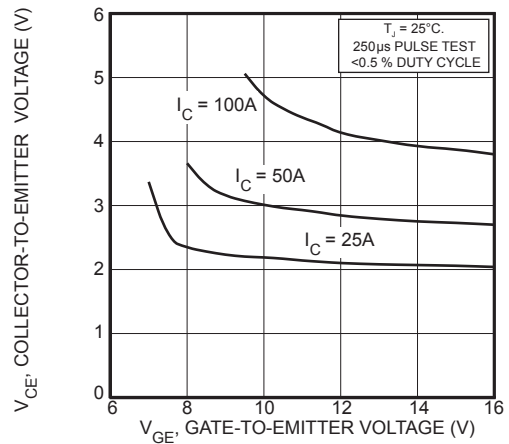

FIGURE 4, On State Voltage vs Gate-to-Emitter Voltage

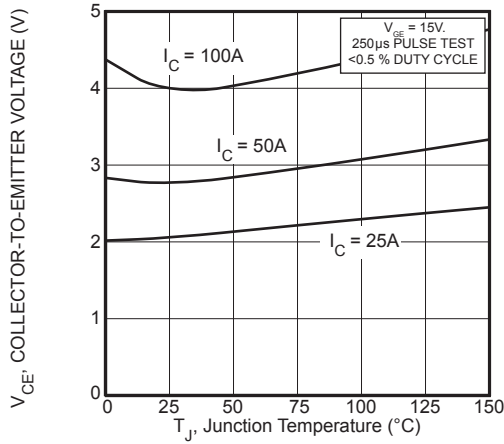

FIGURE 5, On State Voltage vs Junction Temperature

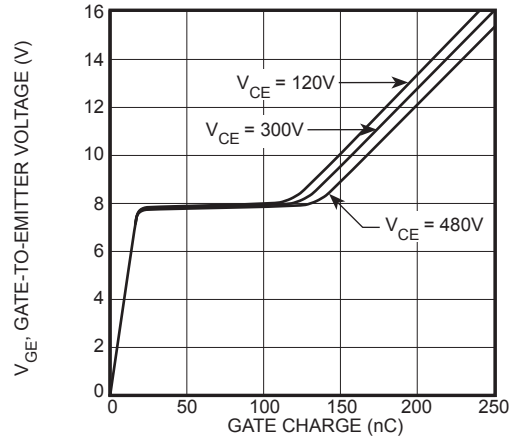

FIGURE 6, Gate Charge

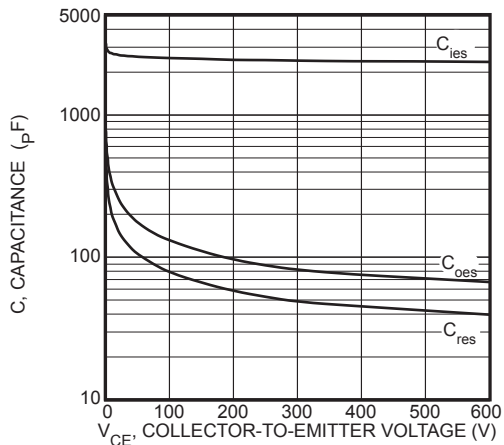

FIGURE 7, Capacitance vs Collector-To-Emitter Voltage

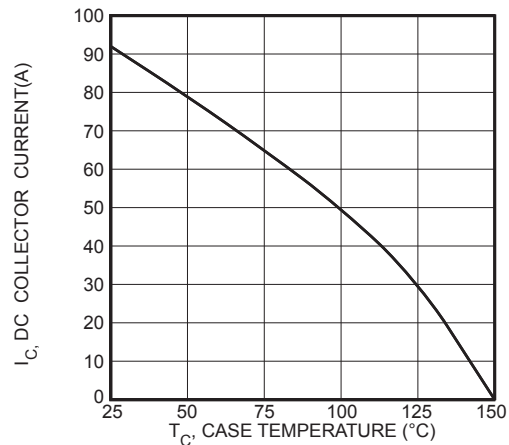

FIGURE 8, DC Collector Current vs Case Temperature

TYPICAL PERFORMANCE CURVES

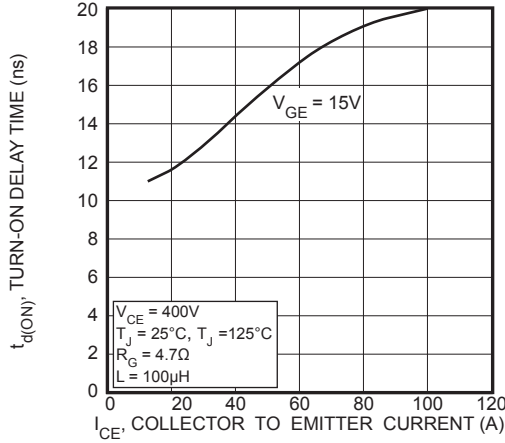

FIGURE 9, Turn-On Delay Time vs Collector Current

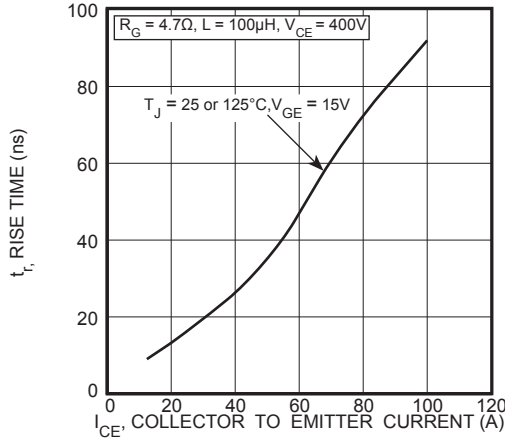

FIGURE 11, Current Rise Time vs Collector Current

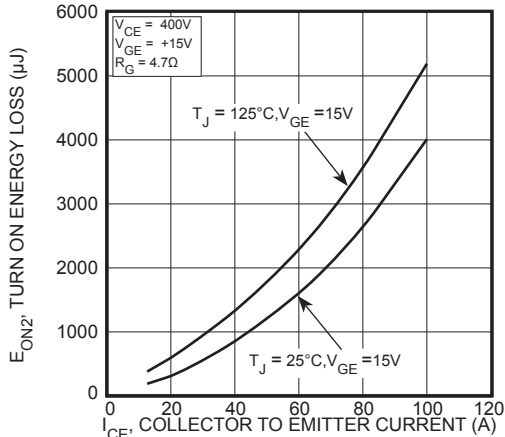

FIGURE 13, Turn-On Energy Loss vs Collector Current

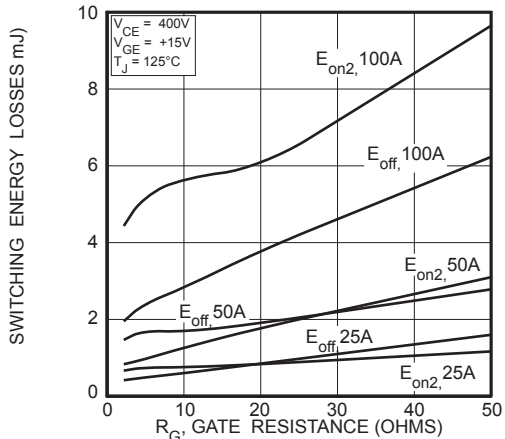

FIGURE 15, Switching Energy Losses vs. Gate Resistance

APT50GS60B_SRDQ2(G)

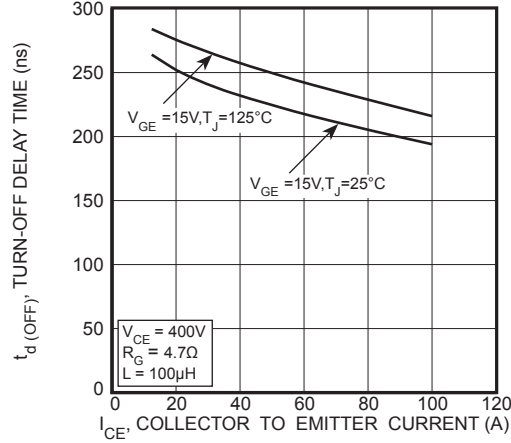

FIGURE 10, Turn-Off Delay Time vs Collector Current

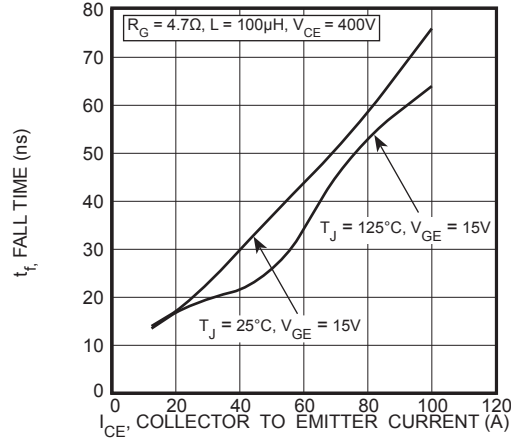

FIGURE 12, Current Fall Time vs Collector Current

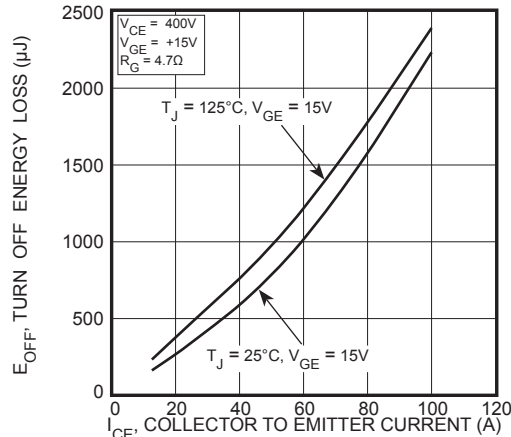

FIGURE 14, Turn Off Energy Loss vs Collector Current

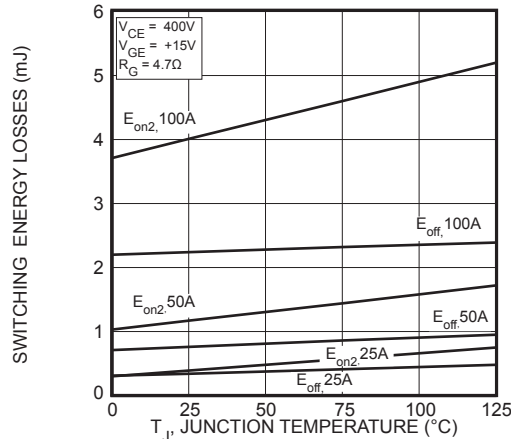
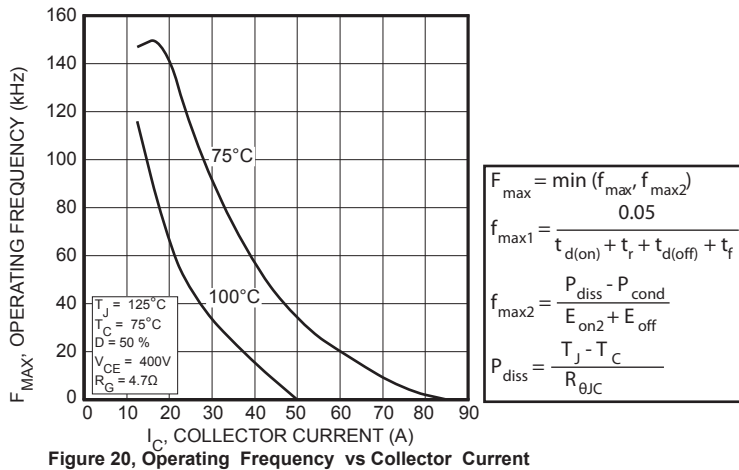
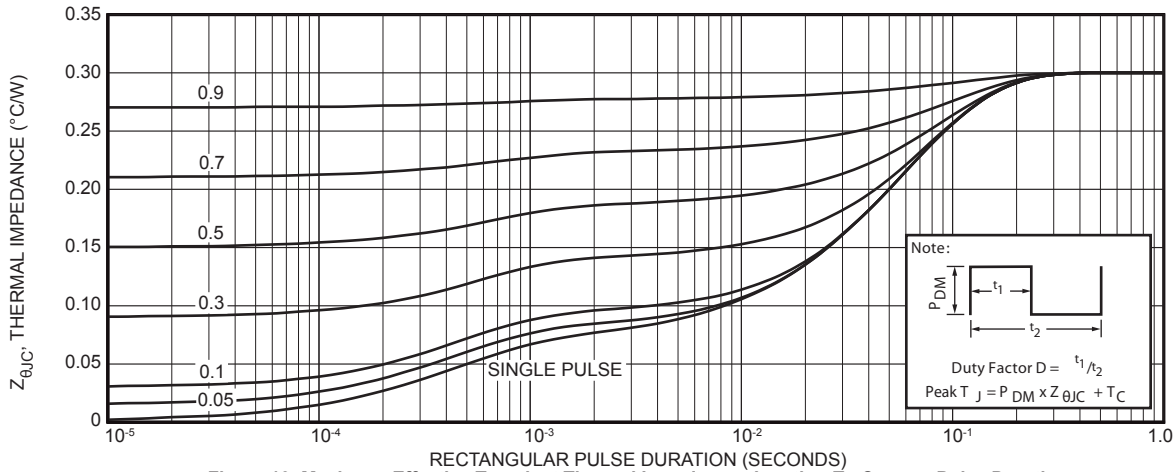
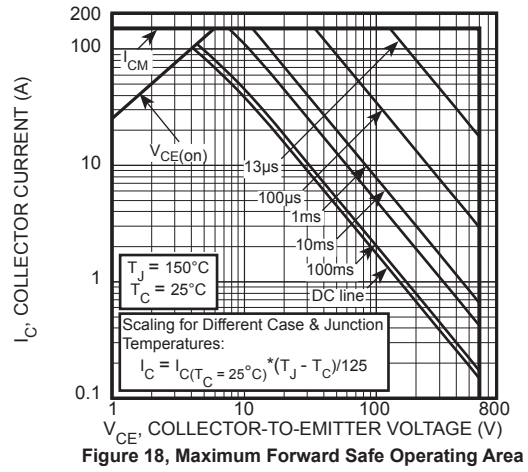
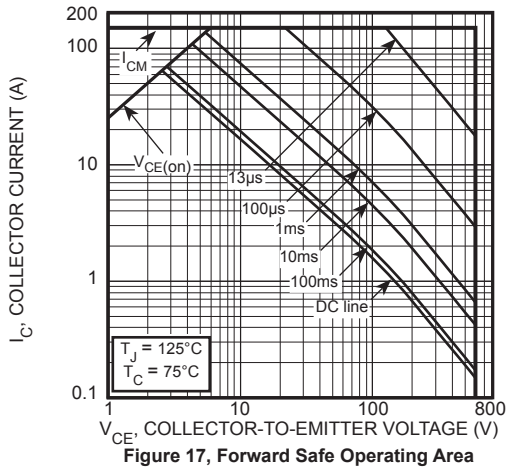

FIGURE 16, Switching Energy Losses vs Junction Temperature

TYPICAL PERFORMANCE CURVES

APT50GS60B_SRDQ2(G)



$$F_{max} = \min(f_{max1}, f_{max2})$$

$$f_{max1} = \frac{0.05}{t_{d(on)} + t_r + t_{d(off)} + t_f}$$

$$f_{max2} = \frac{P_{diss} - P_{cond}}{E_{on2} + E_{off}}$$

$$P_{diss} = \frac{T_J - T_C}{R_{\theta JC}}$$

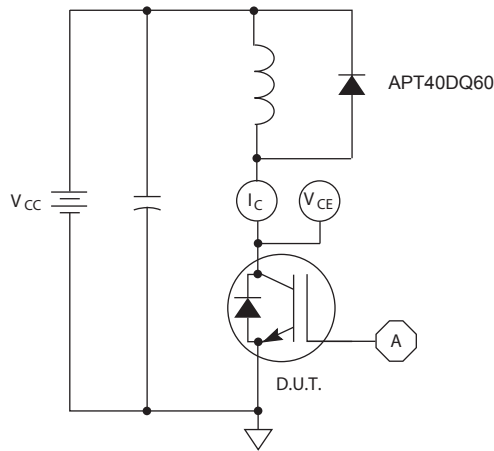

Figure 21, Inductive Switching Test Circuit

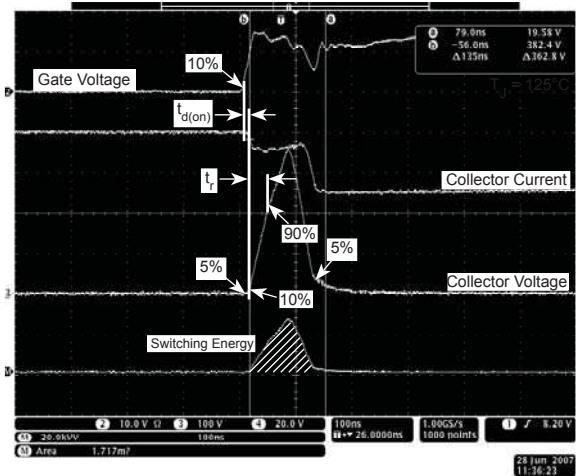

Figure 22, Turn-on Switching Waveforms and Definitions

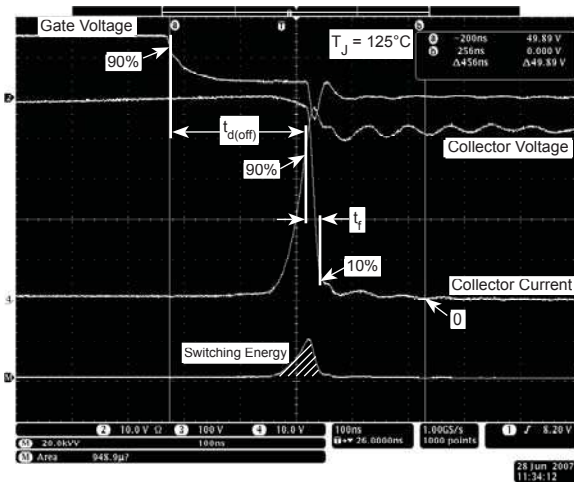

Figure 23, Turn-off Switching Waveforms and Definitions

FOOT NOTE:

- ① Repetitive Rating: Pulse width and case temperature limited by maximum junction temperature.
- ③ Short circuit time: $V_{GE} = 15V, V_{CC} \leq 600V, T_J \leq 150^\circ C$
- ④ Pulse test: Pulse width < 380 μs , duty cycle < 2%
- ⑤ $C_{o(cr)}$ is defined as a fixed capacitance with the same stored charge as C_{oes} with $V_{CE} = 67\%$ of $V_{(BR)CES}$.
- ⑥ $C_{o(er)}$ is defined as a fixed capacitance with the same stored energy as C_{oes} with $V_{CE} = 67\%$ of $V_{(BR)CES}$. To calculate $C_{o(er)}$ for any value of V_{CE} less than $V_{(BR)CES}$, use this equation: $C_{o(er)} = 5.57E-8/V_{DS}^2 + 7.15E-8/V_{DS} + 2.75E-10$.
- 7 R_G is external gate resistance, not including internal gate resistance or gate driver impedance (MIC4452).
- ⑧ E_{on1} is the inductive turn-on energy of the IGBT only, without the effect of a commutating diode reverse recovery current adding to the IGBT turn-on switching loss. It is measured by clamping the inductance with a Silicon Carbide Schottky diode.
- ⑨ E_{on2} is the inductive turn-on energy that includes a commutating diode reverse recovery current in the IGBT turn-on energy.
- ⑩ E_{off} is the clamped inductive turn-off energy measured in accordance with JEDEC standard JESD24-1.

Microsemi reserves the right to change, without notice, the specifications and information contained herein.

ULTRAFAST SOFT RECOVERY ANTI-PARALLEL DIODE

MAXIMUM RATINGS

All Ratings: $T_C = 25^\circ\text{C}$ unless otherwise specified.

Symbol	Characteristic / Test Conditions	APT50GS60B2RDQ2(G)	Unit
$I_{F(AV)}$	Maximum Average Forward Current ($T_C = 103^\circ\text{C}$, Duty Cycle = 0.5)	30	Amps
$I_{F(RMS)}$	RMS Forward Current (Square wave, 50% duty)	43	
I_{FSM}	Non-Repetitive Forward Surge Current ($T_J = 45^\circ\text{C}$, 8.3 ms)	210	

STATIC ELECTRICAL CHARACTERISTICS

Symbol	Characteristic / Test Conditions	Min	Type	Max	Unit	
V_F	Forward Voltage		$I_F = 30\text{A}$	2.8	3.3	Volts
			$I_F = 60\text{A}$	3.4		
			$I_F = 30\text{A}, T_J = 125^\circ\text{C}$	2.1		

DYNAMIC CHARACTERISTICS

Symbol	Characteristic	Test Conditions	Min	Typ	Max	Unit
t_{rr}	Reverse Recovery Time	$I_F = 1\text{A}, di_F/dt = -100\text{A}/\mu\text{s}, V_R = 30\text{V}, T_J = 25^\circ\text{C}$	-	26	-	ns
t_{rr}	Reverse Recovery Time	$I_F = 30\text{A}, di_F/dt = -200\text{A}/\mu\text{s}, V_R = 667\text{V}, T_C = 25^\circ\text{C}$	-	320	-	nAmps
Q_{rr}	Reverse Recovery Charge		-	545	-	
I_{RRM}	Maximum Reverse Recovery Current		-	4	-	Amps
t_{rr}	Reverse Recovery Time	$I_F = 30\text{A}, di_F/dt = -200\text{A}/\mu\text{s}, V_R = 667\text{V}, T_C = 125^\circ\text{C}$	-	435	-	ns
Q_{rr}	Reverse Recovery Charge		-	2100	-	nC
I_{RRM}	Maximum Reverse Recovery Current		-	9	-	Amps
t_{rr}	Reverse Recovery Time	$I_F = 30\text{A}, di_F/dt = -1000\text{A}/\mu\text{s}, V_R = 800\text{V}, T_C = 125^\circ\text{C}$	-	180	-	ns
Q_{rr}	Reverse Recovery Charge		-	2975	-	nC
I_{RRM}	Maximum Reverse Recovery Current		-	28	-	Amps

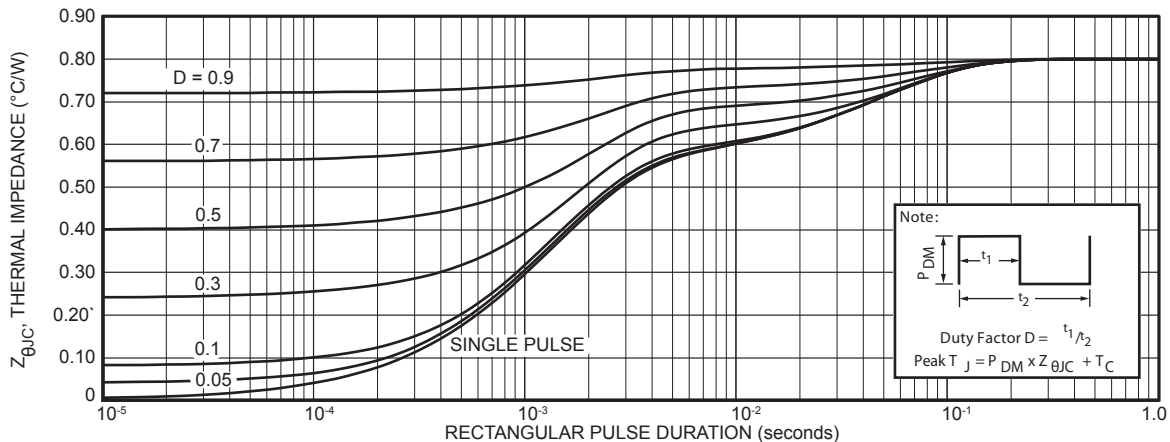

FIGURE 24. MAXIMUM EFFECTIVE TRANSIENT THERMAL IMPEDANCE, JUNCTION-TO-CASE vs. PULSE DURATION

TYPICAL PERFORMANCE CURVES

APT50GS60B_SRDQ2(G)

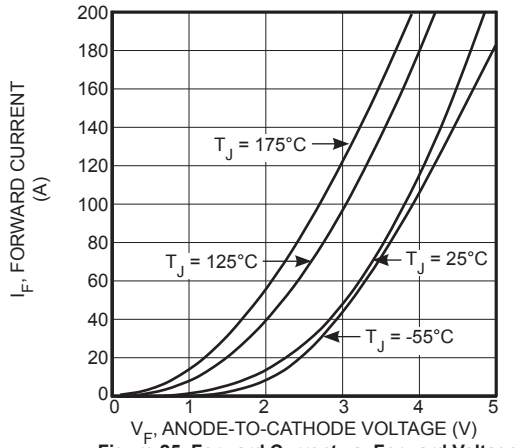

Figure 25. Forward Current vs. Forward Voltage

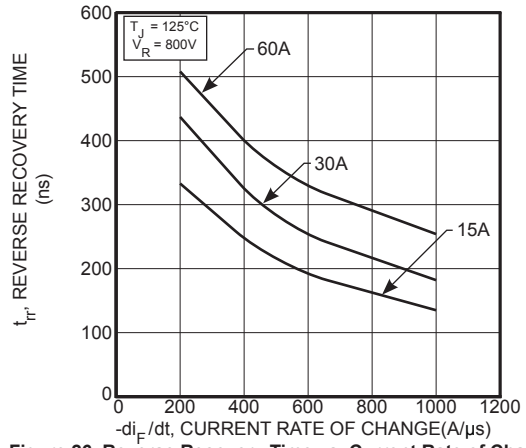

Figure 26. Reverse Recovery Time vs. Current Rate of Change

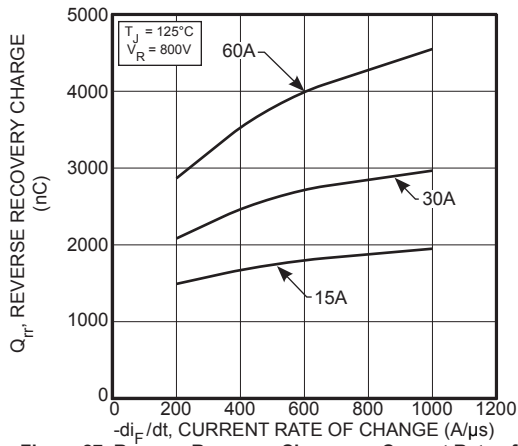

Figure 27. Reverse Recovery Charge vs. Current Rate of Change

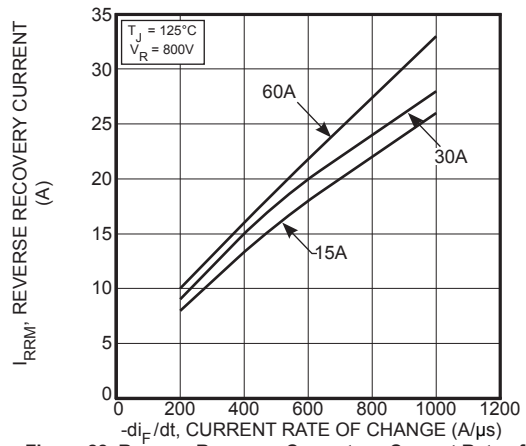

Figure 28. Reverse Recovery Current vs. Current Rate of Change

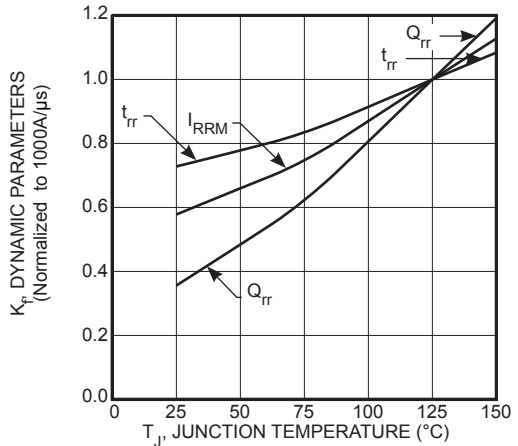

Figure 29. Dynamic Parameters vs. Junction Temperature

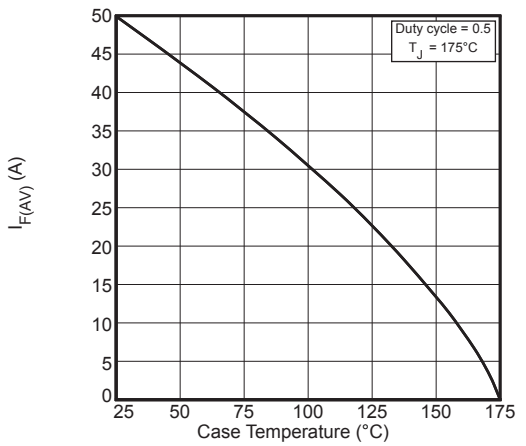

Figure 30. Maximum Average Forward Current vs. Case Temperature

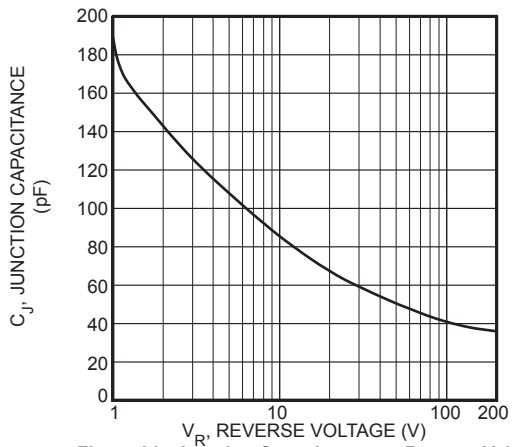

Figure 31. Junction Capacitance vs. Reverse Voltage

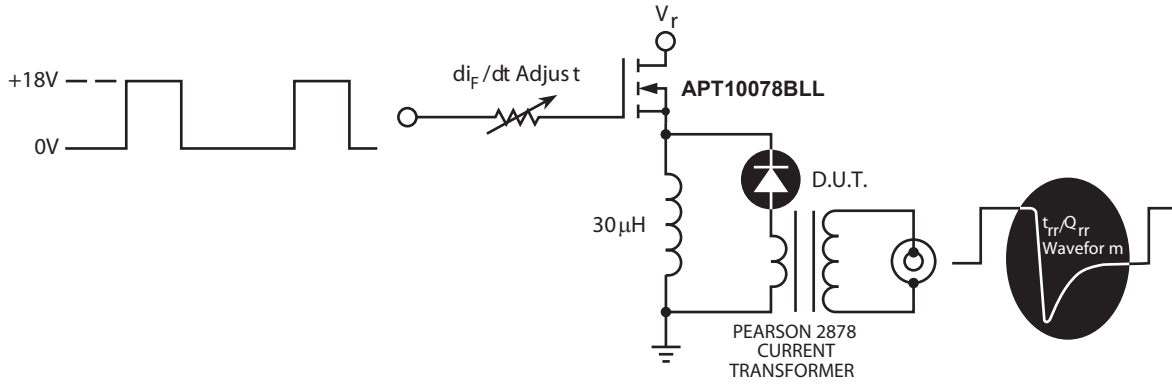

Figure 32. Diode Test Circuit

- 1 I_F - Forward Conduction Current
- 2 di_F/dt - Rate of Diode Current Change Through Zero Crossing.
- 3 I_{RRM} - Maximum Reverse Recovery Current
- 4 t_{rr} - Reverse Recovery Time, measured from zero crossing where the diode current goes from positive to negative, to the point at which the straight line through I_{RRM} and $0.25 I_{RRM}$ passes through zero.
- 5 Q_{rr} - Area Under the Curve Defined by I_{RRM} and t_{rr} .

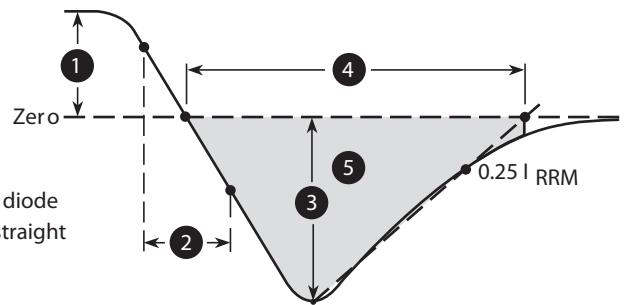
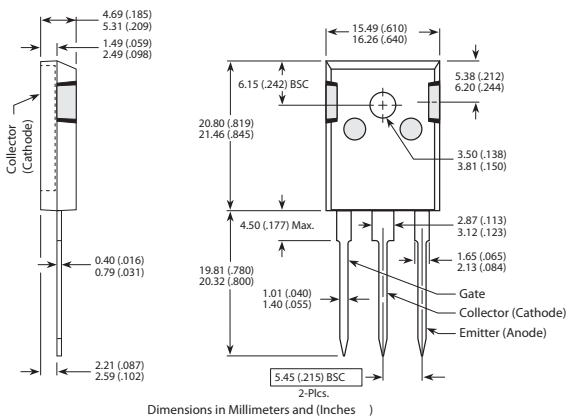

Figure 33. Diode Reverse Recovery Waveform Definitions

TO-247 Package Outline

Ⓢ SAC: Tin, Silver, Copper



D³ Pak Package Outline

e3 SAC: Tin, Silver, Copper

