

# NCP1360, NCP1365

## Low Power Offline Constant Current & Constant Voltage Primary Side PWM Current-Mode Controller with/without High Voltage Startup Current Source

The NCP1360/65 offers a new solution targeting output power levels from a few watts up to 20 W in a universal-mains flyback application. Thanks to a novel method this new controller saves the secondary feedback circuitry (opto-coupler and TL431 reference) while achieving excellent line and load regulation.

The NCP1360/65 operates in valley-lockout quasi-resonant peak current mode control mode at nominal load to provide high efficiency. When the secondary-side power starts diminishing, the switching frequency naturally increases until a voltage-controlled oscillator (VCO) takes the lead, synchronizing the MOSFET turn-on in a drain-source voltage valley. The frequency is thus reduced by stepping into successive valleys until the number 4 is reached. Beyond this point, the frequency is linearly decreased in valley-switching mode until a minimum is hit. This technique keeps the output in regulation with the tiniest dummy load. Valley lockout during the first four drain-source valleys prevents erratic discrete jumps and provides good efficiency in lighter load situations.

### Features

- Primary-Side Feedback Eliminates Opto-coupler and TL431 Reference
- $\pm 5\%$  Voltage Regulation
- $\pm 10\%$  Current Regulation
- 560 V Startup Current Source
- No Frequency Clamp, 80 or 110 kHz Maximum Switching Frequency Options
- Quasi-Resonant Operation with Valley Switching Operation
- Fixed Peak Current & Deep Frequency Foldback @ Light Load Operation.
- External Constant Voltage Feedback Adjustment
- Cycle by Cycle Peak Current Limit
- Build-In Soft-Start
- Over & Under Output Voltage Protection
- Cable Drop Compensation (None, 150 mV, 300 mV or 450 mV option)
- Wide Operation  $V_{CC}$  Range (up to 28 V)



ON Semiconductor®

[www.onsemi.com](http://www.onsemi.com)

### MARKING DIAGRAMS



SOIC-7  
CASE 751U

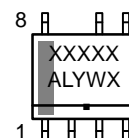

TSOP-6  
CASE 318G

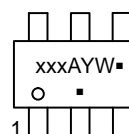

A = Assembly Location  
L = Wafer Lot  
Y = Year  
W, WW = Work Week  
▪ = Pb-Free Package

(Note: Microdot may be in either location)

### ORDERING INFORMATION

See detailed ordering and shipping information on page 27 of this data sheet.

- Low Start-up Current (2.5  $\mu$ A typ.) with NCP1360
- Clamped Gate-drive Output for MOSFET
- $CS$  &  $V_s/ZCD$  pin Short and Open Protection
- Internal Temperature Shutdown
- Less than 10 mW No-Load Performance at High Line with NCP1365 Version
- Less than 30 mW No-Load Performance at High Line with NCP1360 Version
- These are Pb-Free Devices

### Typical Applications

- Low power ac-dc Adapters for Chargers.
- Ac-dc USB chargers for Cell Phones, Tablets and Cameras

# NCP1360, NCP1365

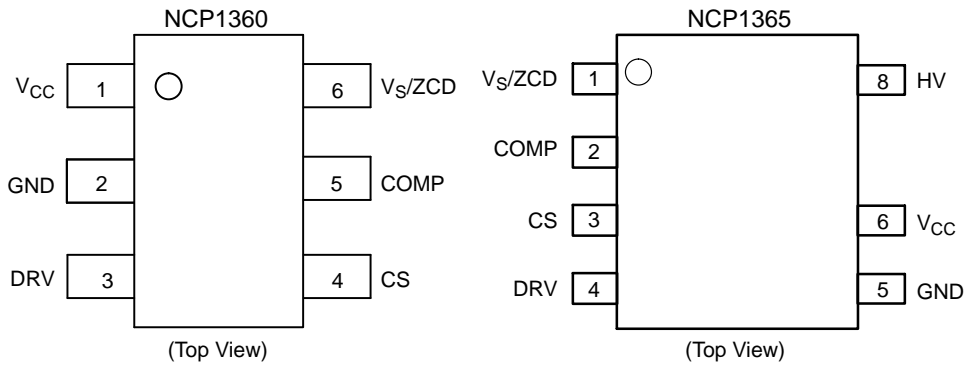

Figure 1. Pin Connections

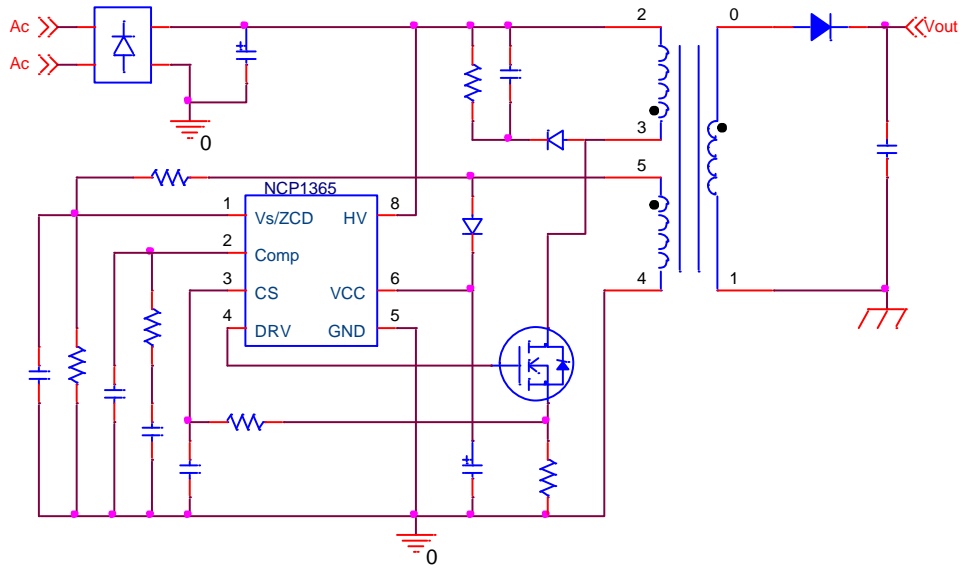

Figure 2. NCP1365 Typical Application Circuit

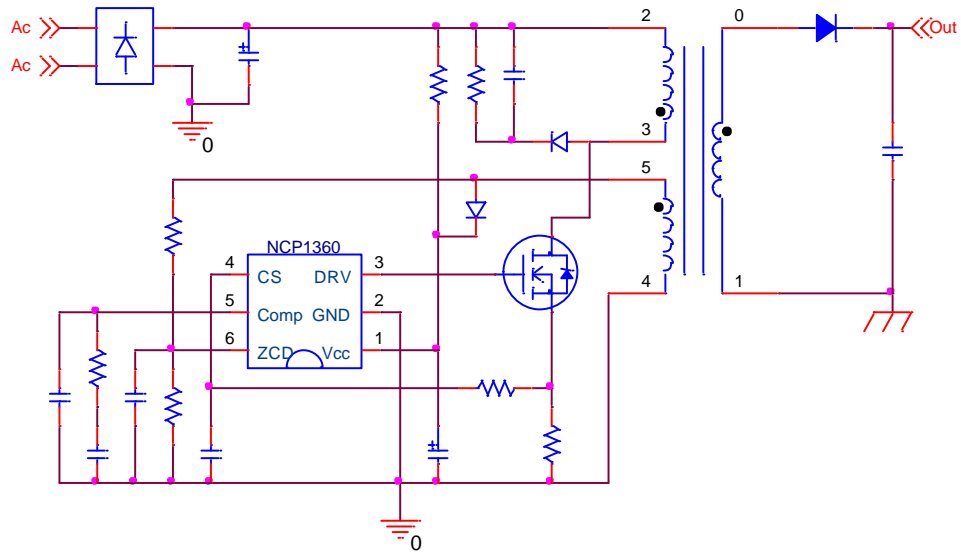

Figure 3. NCP1360 Typical Application Circuit

# NCP1360, NCP1365

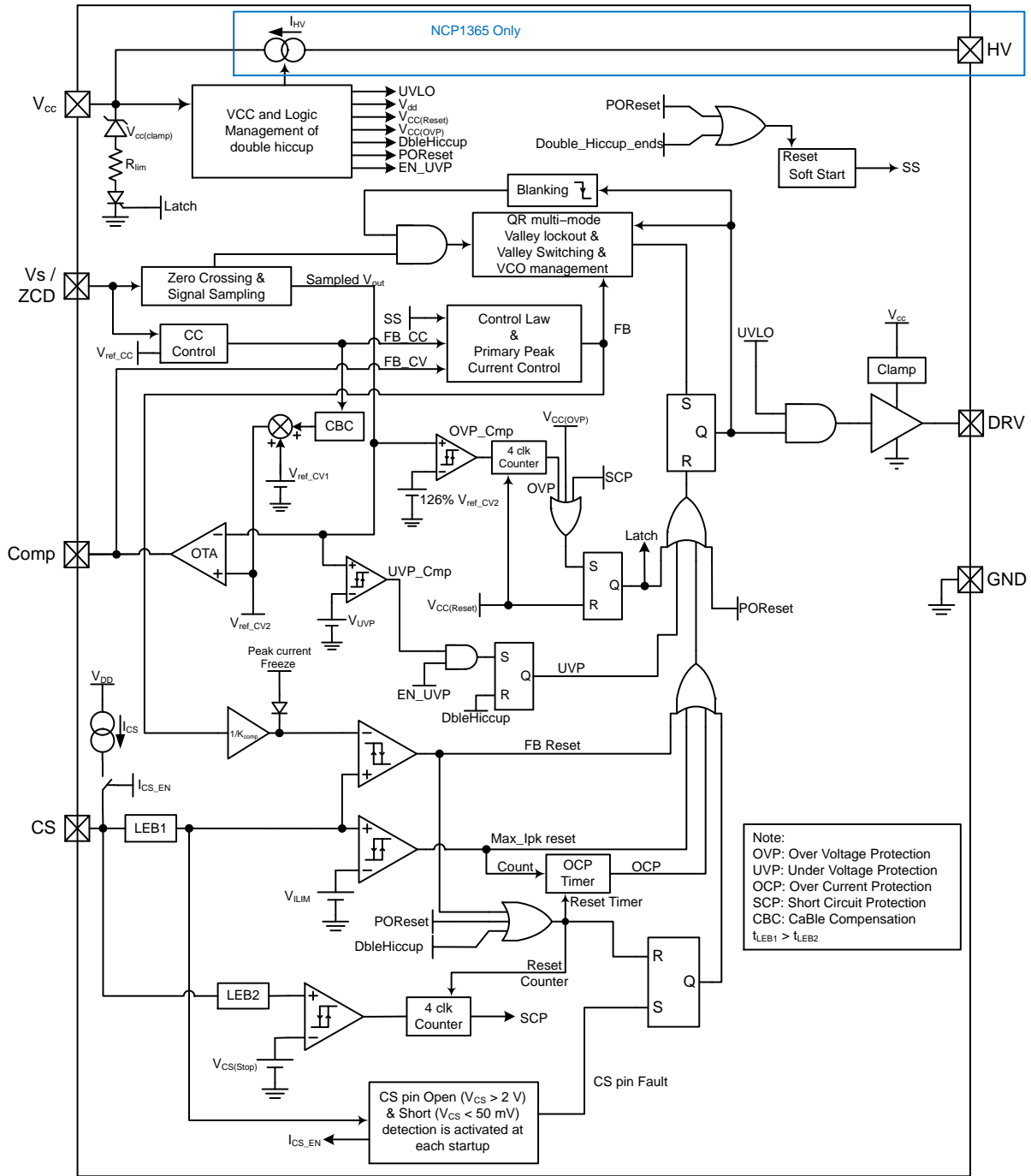

Figure 4. Functional Block Diagram: A Version

# NCP1360, NCP1365

## PIN FUNCTION DESCRIPTION

Pin out NCP1365	Pin out NCP1360	Name	Function
1	6	V <sub>S</sub> /ZCD	Connected to the auxiliary winding; this pin senses the voltage output for the primary regulation and detects the core reset event for the Quasi-Resonant mode of operation.
2	5	Comp	This is the error amplifier output. The network connected between this pin and the ground adjusts the regulation loop bandwidth.
3	4	CS	This pin monitors the primary peak current.
4	3	DRV	Controller switch driver.
5	2	GND	Ground reference.
6	1	V <sub>CC</sub>	This pin is connected to an external auxiliary voltage and supplies the controller.
7	–	NC	Not Connected for creepage distance between high and low Voltage pins
8	–	HV	Connected the high-voltage rail, this pin injects a constant current into the V <sub>CC</sub> capacitor for starting-up the power supply.

## MAXIMUM RATINGS

Symbol	Rating	Value	Unit
V <sub>CC(MAX)</sub>	Maximum Power Supply voltage, VCC pin, continuous voltage	–0.3 to 28	V
ΔV <sub>CC</sub> /Δt	Maximum slew rate on V <sub>CC</sub> pin during startup phase	+0.4	V/μs
V <sub>DRV(MAX)</sub> I <sub>DRV(MAX)</sub>	Maximum driver pin voltage, DRV pin, continuous voltage Maximum current for DRV pin	–0.3, V <sub>DRV</sub> (Note 1) –300, +500	V mA
V <sub>MAX</sub> I <sub>MAX</sub>	Maximum voltage on low power pins (except pins DRV and VCC) Current range for low power pins (except pins DRV and VCC)	–0.3, 5.5 –2, +5	V mA
V <sub>HV</sub>	High Voltage pin voltage	–0.3 to 560	V
R <sub>θJ-A</sub>	Thermal Resistance Junction-to-Air	200	°C/W
T <sub>J(MAX)</sub>	Maximum Junction Temperature	150	°C
	Operating Temperature Range	–40 to +125	°C
	Storage Temperature Range	–60 to +150	°C
	Human Body Model ESD Capability per JEDEC JESD22-A114F	2	kV
	Machine Model ESD Capability (All pins except DRV) per JEDEC JESD22-A115C	200	V
	Charged-Device Model ESD Capability per JEDEC JESD22-C101E	500	V

Stresses exceeding those listed in the Maximum Ratings table may damage the device. If any of these limits are exceeded, device functionality should not be assumed, damage may occur and reliability may be affected.

- V<sub>DRV</sub> is the DRV clamp voltage V<sub>DRV(high)</sub> when V<sub>CC</sub> is higher than V<sub>DRV(high)</sub>. V<sub>DRV</sub> is V<sub>CC</sub> otherwise
- This device contains latch-up protection and exceeds 100 mA per JEDEC Standard JESD78.

# NCP1360, NCP1365

**ELECTRICAL CHARACTERISTICS:** ( $V_{CC} = 12\text{ V}$ ,  $C_{DRV} = 1\text{ nF}$ , For typical values  $T_J = 25^\circ\text{C}$ , for min/max values  $T_J = -40^\circ\text{C}$  to  $+125^\circ\text{C}$ , Max  $T_J = 150^\circ\text{C}$ , unless otherwise noted)

Characteristics	Conditions	Symbol	Min	Typ	Max	Unit
-----------------	------------	--------	-----	-----	-----	------

## HIGH VOLTAGE STARTUP SECTION (NCP1365 only)

Startup current sourced by $V_{CC}$ pin	$V_{HV} = 100\text{ V}$	$I_{HV}$	70	100	150	$\mu\text{A}$
Leakage current at HV	$V_{HV} = 400\text{ V}$	$I_{HV\_LKG}$	–	0.1	1	$\mu\text{A}$
Minimum Start-up HV voltage	$I_{HV} = 95\%$ of $I_{HV}@V_{HV} = 100\text{ V}$ , $V_{CC} = V_{CC(ON)} - 0.2\text{ V}$	$V_{HV(min)}$	–	22	25	V

## SUPPLY SECTION AND $V_{CC}$ MANAGEMENT

$V_{CC}$ level at which driving pulses are authorized	$V_{CC}$ increasing	$V_{CC(ON)}$	16	18	20	V
$V_{CC}$ level at which driving pulses are stopped	$V_{CC}$ decreasing	$V_{CC(OFF)}$	6.0	6.5	7.0	V
Internal Latch / Logic Reset Level $V_{CC}$ clamp level		$V_{CC(reset)}$	–	5.6	–	V
$V_{CC}$ clamp level (A & C version)	Activated after Latch protection @ $I_{CC} = 100\text{ }\mu\text{A}$	$V_{CC(Clamp)}$	–	4.2	–	V
Minimal current into $V_{CC}$ pin that keeps the controller Latched (NCP1365, A & C fault mode version)		$I_{CC(Clamp)}$	–	–	20	$\mu\text{A}$
Minimal current into $V_{CC}$ pin that keeps the controller Latched (NCP1360, A & C fault mode version)		$I_{CC(Clamp)}$	–	–	6	$\mu\text{A}$
Current-limit resistor in series with the latch SCR		$R_{lim}$	–	7	–	k $\Omega$
Over Voltage Protection	Over Voltage threshold	$V_{CC(OVP)}$	24	26	28	V
Start-up supply current, controller disabled or latched (Only valid with NCP1360)	$V_{CC} < V_{CC(ON)}$ & $V_{CC}$ increasing from 0 V	$I_{CC1}$	–	2.5	5.0	$\mu\text{A}$
Internal IC consumption, steady state	$F_{sw} = 65\text{ kHz}$ , $C_{DRV} = 1\text{ nF}$	$I_{CC2}$	–	1.7	2.5	mA
Internal IC consumption, frequency foldback mode	VCO mode, $F_{sw} = 1\text{ kHz}$ , $C_{DRV} = 1\text{ nF}$	$I_{CC3}$	–	0.8	1.2	mA
Internal IC consumption when STBY mode is activated	VCO mode, $F_{sw} = f_{VCO(min)}$ , $V_{Comp} = GND$ , $C_{DRV} = 1\text{ nF}$ $f_{VCO(min)} = 200\text{ Hz}$ $f_{VCO(min)} = 600\text{ Hz}$ $f_{VCO(min)} = 1.2\text{ kHz}$	$I_{CC4}$	–	200	250	$\mu\text{A}$
			–	220	280	
			–	270	330	

## CURRENT COMPARATOR

Current Sense Voltage Threshold	$V_{Comp} = V_{Comp(max)}$ , $V_{CS}$ increasing	$V_{ILIM}$	0.76	0.80	0.84	V
Cycle by Cycle Leading Edge Blanking Duration		$t_{LEB1}$	250	300	360	ns
Cycle by Cycle Current Sense Propagation Delay	$V_{CS} > (V_{ILIM} + 100\text{ mV})$ to DRV turn-off	$t_{LIM}$	–	50	100	ns
Timer Delay Before Latching in Overload Condition	When CS pin $\geq V_{ILIM}$ (Note 3)	$T_{OCP}$	50	70	90	ms

Product parametric performance is indicated in the Electrical Characteristics for the listed test conditions, unless otherwise noted. Product performance may not be indicated by the Electrical Characteristics if operated under different conditions.

3. The timer can be reset if there are 4 DRV cycles without overload or short circuit conditions

4. Guaranteed by Design.

# NCP1360, NCP1365

**ELECTRICAL CHARACTERISTICS:** ( $V_{CC} = 12\text{ V}$ ,  $C_{DRV} = 1\text{ nF}$ , For typical values  $T_J = 25^\circ\text{C}$ , for min/max values  $T_J = -40^\circ\text{C}$  to  $+125^\circ\text{C}$ , Max  $T_J = 150^\circ\text{C}$ , unless otherwise noted)

Characteristics	Conditions	Symbol	Min	Typ	Max	Unit
<b>CURRENT COMPARATOR</b>						
Threshold for Immediate Fault Protection Activation		$V_{CS(\text{stop})}$	1.08	1.2	1.32	V
Leading Edge Blanking Duration for $V_{CS(\text{stop})}$		$t_{LEB2}$	–	120	–	ns
Maximum peak current level at which VCO takes over or frozen peak current	$V_{Comp} < 1.9\text{ V}$ , $V_{CS}$ increasing ( $\sim 15\%V_{ILIM}$ )	$V_{CS(VCO)}$	–	120	–	mV
<b>REGULATION BLOCK</b>						
Internal Voltage reference for Constant Current regulation	$T_J = 25^\circ\text{C}$ $-40^\circ\text{C} < T_J < 125^\circ\text{C}$	$V_{ref\_CC}$	0.98 0.97	1.00 1.00	1.02 1.03	V
Internal Voltage reference for Constant Voltage regulation	$T_J = 25^\circ\text{C}$ $-40^\circ\text{C} < T_J < 125^\circ\text{C}$	$V_{ref\_CV1}$	2.450 2.425	2.500 2.500	2.550 2.575	V
Internal Voltage reference for Constant Voltage regulation when cable compensation is enabled		$V_{ref\_CV2}$	–	$V_{ref\_CV1+}$ (CBC/2)	–	V
Error Amplifier Current Capability		$I_{EA}$	–	$\pm 40$	–	$\mu\text{A}$
Error Amplifier Gain		$G_{EA}$	150	200	250	$\mu\text{S}$
Error Amplifier Output Voltage	Internal offset on Comp pin	$V_{Comp(\text{max})}$ $V_{Comp(\text{min})}$ $V_{Comp(\text{offset})}$	– – –	4.9 0 1.1	– – –	V
Internal Current Setpoint Division Ratio		$K_{Comp}$	–	4.0	–	–
Valley Thresholds						V
Transition from 1 <sup>st</sup> to 2 <sup>nd</sup> valley	$V_{Comp}$ decreasing	$V_{H2D}$	–	2.50	–	
Transition from 2 <sup>nd</sup> to 3 <sup>rd</sup> valley	$V_{Comp}$ decreasing	$V_{H3D}$	–	2.30	–	
Transition from 3 <sup>rd</sup> to 4 <sup>th</sup> valley	$V_{Comp}$ decreasing	$V_{H4D}$	–	2.10	–	
Transition from 4 <sup>th</sup> valley to VCO	$V_{Comp}$ decreasing	$V_{HVCO D}$	–	1.90	–	
Transition from VCO to 4 <sup>th</sup> valley	$V_{Comp}$ increasing	$V_{HVCO I}$	–	2.50	–	
Transition from 4 <sup>th</sup> to 3 <sup>rd</sup> valley	$V_{Comp}$ increasing	$V_{H4I}$	–	2.70	–	
Transition from 3 <sup>rd</sup> to 2 <sup>nd</sup> valley	$V_{Comp}$ increasing	$V_{H3I}$	–	2.90	–	
Transition from 2 <sup>nd</sup> to 1 <sup>st</sup> valley	$V_{Comp}$ increasing	$V_{H2I}$	–	3.10	–	
Minimal difference between any two valleys	$V_{Comp}$ increasing or $V_{Comp}$ decreasing	$\Delta V_H$	176	–	–	mV
Internal Dead Time generation for VCO mode	Entering in VCO when $V_{comp}$ is decreasing and crosses $V_{HVCO D}$	$T_{DT(\text{start})}$	–	2	–	$\mu\text{s}$
Internal Dead Time generation for VCO mode	Leaving VCO mode when $V_{comp}$ is increasing and crosses $V_{HVCO I}$	$T_{DT(\text{ends})}$	–	1	–	$\mu\text{s}$
Internal Dead Time generation for VCO mode	When in VCO mode $V_{Comp} = 1.8\text{ V}$ $V_{Comp} = 1.3\text{ V}$ $V_{Comp} = 0.8\text{ V}$ $V_{Comp} < 0.4\text{ V}$ – 200 Hz option (Note 4) $V_{Comp} < 0.4\text{ V}$ – 600 Hz option (Note 4) $V_{Comp} < 0.4\text{ V}$ – 1.2 kHz option (Note 4)	$T_{DT}$	– – – – – –	6 25 220 5000 1667 833	– – – – – –	$\mu\text{s}$
Minimum Operating Frequency in VCO Mode	$V_{Comp} = \text{GND}$	$f_{VCO(\text{MIN})}$	150 450 0.9	200 600 1.2	250 750 1.5	Hz Hz kHz

Product parametric performance is indicated in the Electrical Characteristics for the listed test conditions, unless otherwise noted. Product performance may not be indicated by the Electrical Characteristics if operated under different conditions.

3. The timer can be reset if there are 4 DRV cycles without overload or short circuit conditions
4. Guaranteed by Design.

# NCP1360, NCP1365

**ELECTRICAL CHARACTERISTICS:** ( $V_{CC} = 12\text{ V}$ ,  $C_{DRV} = 1\text{ nF}$ , For typical values  $T_J = 25^\circ\text{C}$ , for min/max values  $T_J = -40^\circ\text{C}$  to  $+125^\circ\text{C}$ , Max  $T_J = 150^\circ\text{C}$ , unless otherwise noted)

Characteristics	Conditions	Symbol	Min	Typ	Max	Unit
-----------------	------------	--------	-----	-----	-----	------

## REGULATION BLOCK

Maximum Operating Frequency		$f_{MAX}$	–	No Clamp	–	N/A
			75	80	85	kHz
	Option Option		103	110	117	kHz

## DEMAGNETIZATION INPUT – ZERO VOLTAGE DETECTION CIRCUIT and VOLTAGE SENSE

$V_{ZCD}$ threshold voltage	$V_{ZCD}$ decreasing	$V_{ZCD(TH)}$	25	45	65	mV
$V_{ZCD}$ Hysteresis	$V_{ZCD}$ increasing	$V_{ZCD(HYS)}$	15	30	45	mV
Threshold voltage for output short circuit or aux. winding short circuit detection	After $t_{BLANK\_ZCD}$ if $V_{ZCD} < V_{ZCD(short)}$ → Latched	$V_{ZCD(short)}$	30	50	70	mV
Propagation Delay from valley detection to DRV high	$V_{ZCD}$ decreasing from 4 V to 0 V	$t_{DEM}$	–	–	170	ns
Delay after on–time that the $V_S/ZCD$ is still pulled to ground	(Note 4)	$t_{short\_ZCD}$	–	0.7	–	$\mu\text{s}$
Blanking delay after on–time ( $V_S/ZCD$ pin is disconnected from the internal circuitry)		$t_{blank\_ZCD}$	1.2	1.5	1.8	$\mu\text{s}$
Timeout after last demagnetization transition	Timeout while in Soft–start Timeout after soft–start complete	$t_{outSS}$ $t_{out}$	36 4.5	44 5.5	52 6.5	$\mu\text{s}$
Input leakage current	$V_{CC} > V_{CC(on)}$ $V_{ZCD} = 4\text{ V}$ , DRV is low	$I_{ZCD}$	–	–	0.1	$\mu\text{A}$

## DRIVE OUTPUT – GATE DRIVE

Drive resistance DRV Sink DRV Source		$R_{SNK}$ $R_{SRC}$	– –	7 12	– –	$\Omega$
	Rise time	$C_{DRV} = 1\text{ nF}$ , from 10% to 90%	$t_r$	–	45	80
Fall time	$C_{DRV} = 1\text{ nF}$ , from 90% to 10%	$t_f$	–	30	60	ns
DRV Low voltage	$V_{CC} = V_{CC(off)} + 0.2\text{ V}$ , $C_{DRV} = 220\text{ pF}$ , $R_{DRV} = 33\text{ k}\Omega$	$V_{DRV(low)}$	6.0	–	–	V
DRV High voltage	$V_{CC} = V_{CC(OVP)} - 0.2\text{ V}$ , $C_{DRV} = 220\text{ pF}$ , $R_{DRV} = 33\text{ k}\Omega$	$V_{DRV(high)}$	–	–	13.0	V

## SOFT START

Internal Fixed Soft Start Duration	Current Sense peak current rising from 0.2 V to 0.8 V	$t_{SS}$	3	4	5	ms
------------------------------------	---	----------	---	---	---	----

## FAULT PROTECTION

Thermal Shutdown	Device switching ( $F_{sw} \sim 65\text{ kHz}$ ) (Note 4)	$T_{SHTDN}$	–	150	–	$^\circ\text{C}$
Thermal Shutdown Hysteresis	Device switching ( $F_{sw} \sim 65\text{ kHz}$ ) (Note 4)	$T_{SHTDN(HYS)}$	–	40	–	$^\circ\text{C}$
Number of Drive cycle before latch confirmation	$V_{Comp} = V_{Comp(max)}$ , $V_{CS} > V_{CS(stop)}$ Or Internal sampled $V_{out} > V_{OVP}$	$T_{latch\_count}$	–	4	–	–
Fault level detection for OVP → Latched ( $V_{CC} = V_{CC(clamp)}$ with low consumption mode)	Internal sampled $V_{out}$ increasing $V_{OVP} = V_{ref\_CV2} + 26\%$	$V_{OVP}$	2.95	3.15	3.35	V

Product parametric performance is indicated in the Electrical Characteristics for the listed test conditions, unless otherwise noted. Product performance may not be indicated by the Electrical Characteristics if operated under different conditions.

3. The timer can be reset if there are 4 DRV cycles without overload or short circuit conditions
4. Guaranteed by Design.

## NCP1360, NCP1365

**ELECTRICAL CHARACTERISTICS:** ( $V_{CC} = 12\text{ V}$ ,  $C_{DRV} = 1\text{ nF}$ , For typical values  $T_J = 25^\circ\text{C}$ , for min/max values  $T_J = -40^\circ\text{C}$  to  $+125^\circ\text{C}$ , Max  $T_J = 150^\circ\text{C}$ , unless otherwise noted)

Characteristics	Conditions	Symbol	Min	Typ	Max	Unit
-----------------	------------	--------	-----	-----	-----	------

### FAULT PROTECTION

Fault level detection for UVP → Double Hiccup autorecovery (UVP detection is disabled during $T_{EN\_UVP}$ )	Internal sampled $V_{out}$ decreasing	$V_{UVP}$	1.4	1.5	1.6	V
Blanking time for UVP detection	Starting at the beginning of the Soft start	$T_{EN\_UVP}$	–	37	–	ms
Pull-up Current Source on CS pin for Open or Short circuit detection	When $V_{CS} > V_{CS\_min}$	$I_{CS}$	–	55	–	$\mu\text{A}$
CS pin Open detection	CS pin open	$V_{CS(open)}$	0.8	–	–	V
CS pin Short detection		$V_{CS\_min}$	–	50	70	mV
CS pin Short detection timer	(Note 4)	$T_{CS\_short}$	–	3	–	$\mu\text{s}$

### CABLE DROP COMPENSATION

Offset applied on $V_{ref\_CV1}$ at the maximum constant current		CBC				mV
	Option A		–	None	–	
	Option B		–	150	–	
	Option C		–	300	–	
	Option D		–	450	–	

Product parametric performance is indicated in the Electrical Characteristics for the listed test conditions, unless otherwise noted. Product performance may not be indicated by the Electrical Characteristics if operated under different conditions.

3. The timer can be reset if there are 4 DRV cycles without overload or short circuit conditions
4. Guaranteed by Design.



## NCP1360, NCP1365

### FAULT MODE STATES TABLE WHATEVER THE VERSION

Event	Timer Protection	Next Device Status	Release to Normal Operation Mode
Overcurrent $V_{CS} > V_{ILIM}$	OCF timer	Double Hiccup	<ul style="list-style-type: none"> <li>Resume to normal operation: if 4 pulses from FB Reset &amp; then Reset timer</li> <li>Resume operation after Double Hiccup</li> </ul>
Winding short $V_{CS} > V_{CS(stop)}$	Immediate	4 consecutive pulses with $V_{CS} > V_{CS(stop)}$ before Latching	$V_{CC}$ is decreasing to $V_{CC(clamp)}$ and waiting for unplug from line $V_{CC} < V_{CC(reset)}$
CS pin Fault: Short & Open	Immediate	Double Hiccup	Resume operation after Double Hiccup
Low supply $V_{CC} < V_{CC(off)}$	10 $\mu$ s timer	Double Hiccup	Resume operation after Double Hiccup
Internal TSD	10 $\mu$ s timer	Double Hiccup	Resume operation after Double Hiccup & $T < (T_{SHTDN} - T_{SHTDN(Hyst)})$
ZCD short $V_{ZCD} < V_{ZCD(short)}$ after $t_{BLANK\_ZCD}$ time	Immediate	Double Hiccup	Resume operation after Double Hiccup ( $V_{CC(on)} < V_{CC} < V_{CC(reset)}$ )

### FAULT MODE STATES TABLE ACCORDING THE CONTROLLER VERSIONS

Event	A Version	B Version	C Version
High supply $V_{CC} > V_{CC(ovp)}$	Latched_Timer	Autorecovery	Latched_Timer
Internal $V_{out}$ OVP: $V_{out} > 126\% V_{ref\_CV2}$	Latched_4clk	Autorecovery	Latched_4clk
Internal $V_{out}$ UVP: $V_{out} < 60\% V_{ref\_CV2}$ , when $V_{out}$ is decreasing only	Autorecovery	Autorecovery	Latched_Timer

### FAULT TYPE MODE DEFINITION

Fault Mode	Timer Protection	Next Device Status	Release to Normal Operation Mode
Latched_Timer	10 $\mu$ s timer	Latched	$V_{CC}$ is decreasing to $V_{CC(clamp)}$ and waiting for unplug from line $V_{CC} < V_{CC(reset)}$
Latched_4clk	Immediate	4 consecutive pulses with $V_{OUT} > 126\% V_{ref\_CV2}$ before Latching	$V_{CC}$ is decreasing to $V_{CC(clamp)}$ and waiting for unplug from line $V_{CC} < V_{CC(reset)}$
Autorecovery	Immediate	Resume operation after Double Hiccup	Resume operation after Double Hiccup ( $V_{CC(on)} < V_{CC} < V_{CC(reset)}$ )

# NCP1360, NCP1365

## CHARACTERIZATION CURVES

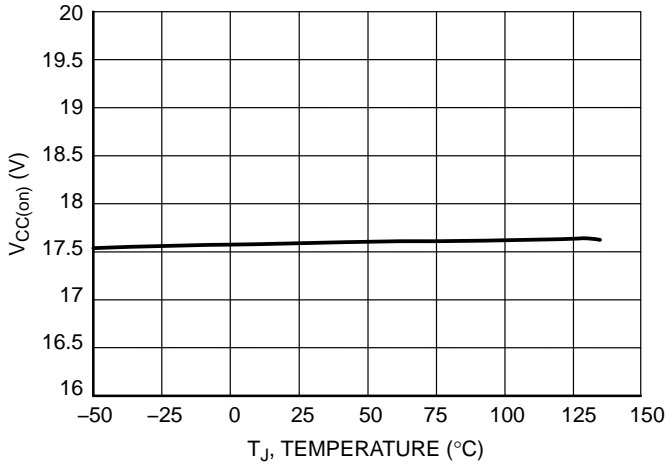

Figure 5. V<sub>CC</sub> Startup Threshold versus Temperature

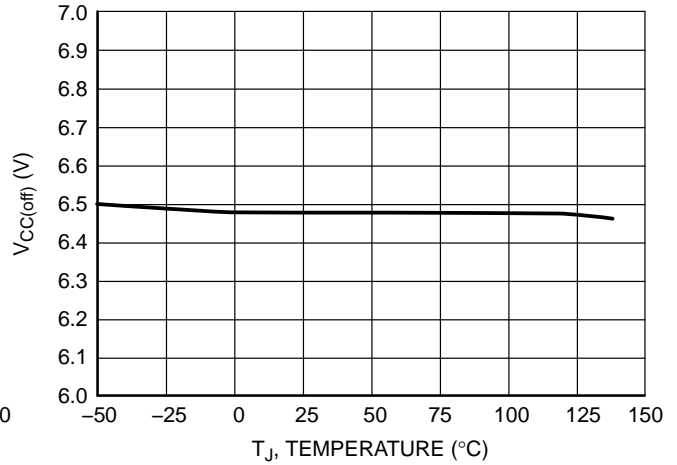

Figure 6. V<sub>CC</sub> Minimum Operating versus Temperature

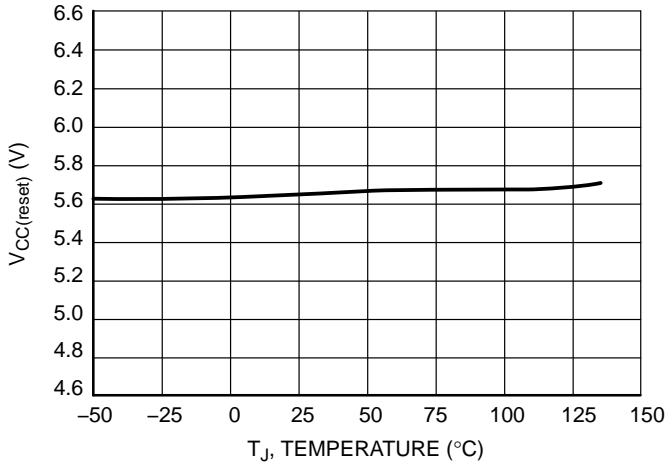

Figure 7. V<sub>CC(reset)</sub> versus Temperature

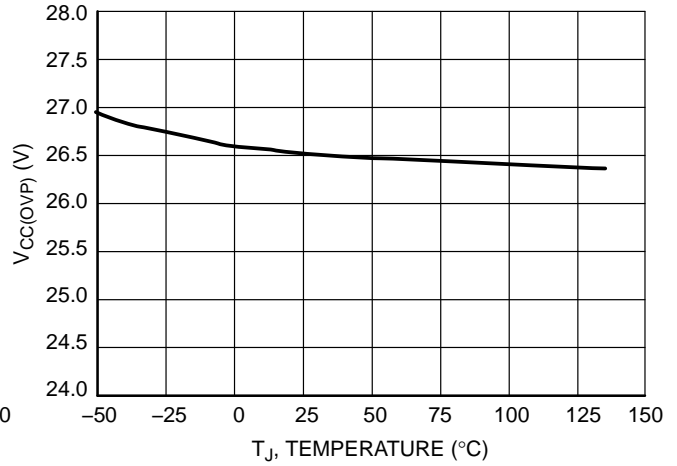

Figure 8. V<sub>CC(OVP)</sub> versus Temperature

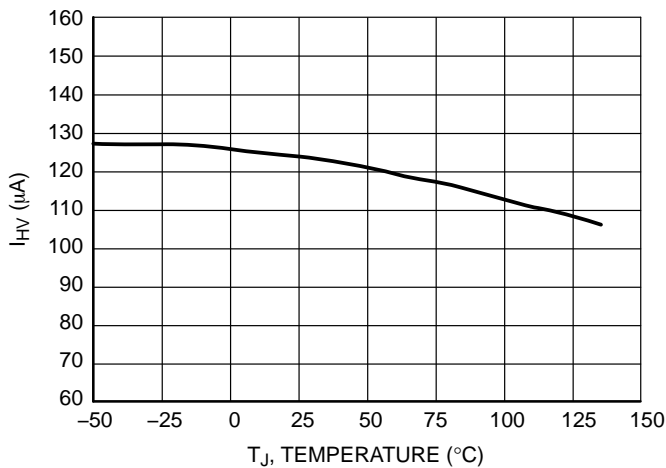

Figure 9. Startup Current Source versus Temperature

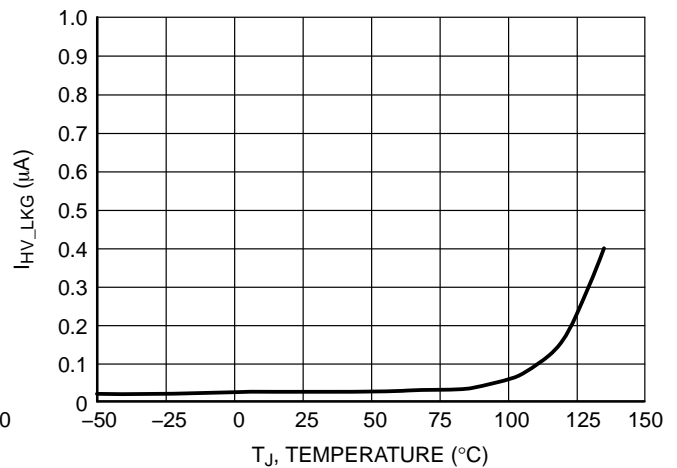
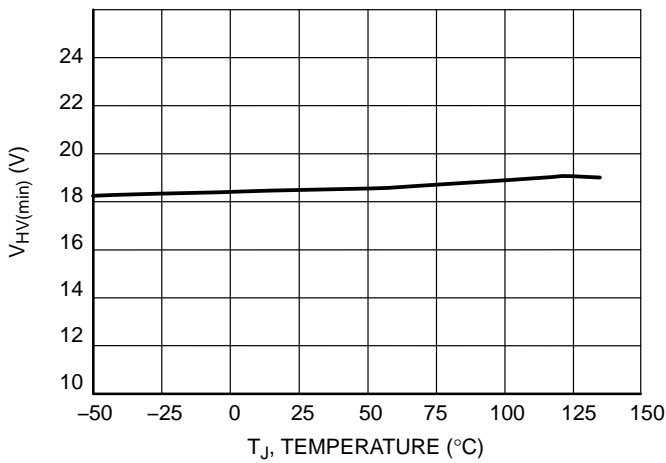

Figure 10. HV Pin Leakage versus Temperature

# NCP1360, NCP1365

## CHARACTERIZATION CURVES



**Figure 11. Minimum Voltage for HV Startup Current Source versus Temperature**

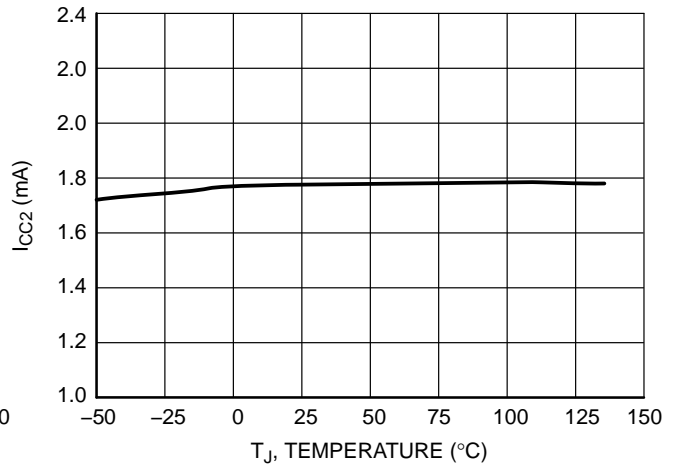

**Figure 12. I<sub>CC2</sub> versus Temperature**

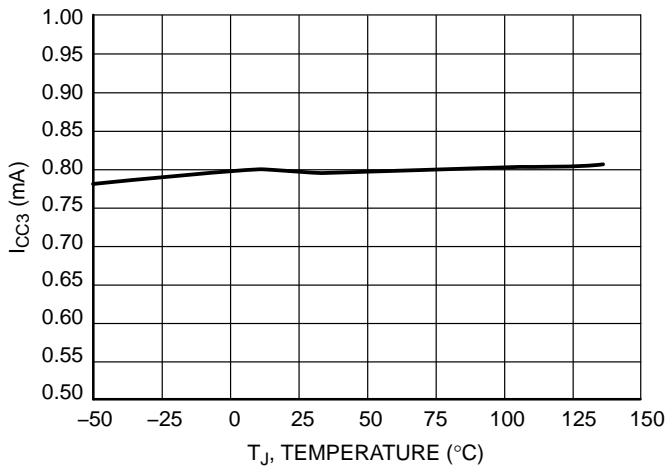

**Figure 13. I<sub>CC3</sub> versus Temperature**

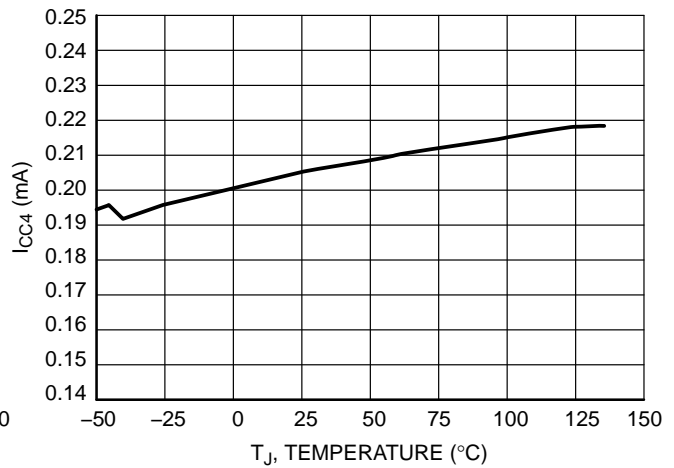

**Figure 14. Standby Current Consumption (200 Hz option) versus Temperature**

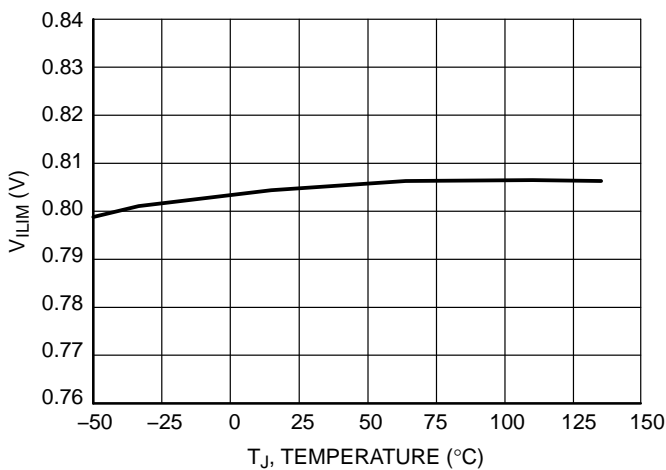

**Figure 15. Max Peak Current Limit versus Temperature**

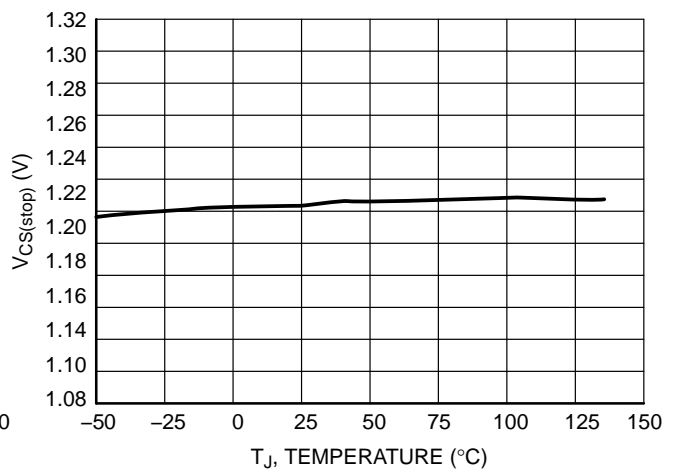

**Figure 16. Second Peak Current Limit for Fault Protection versus Temperature**

# NCP1360, NCP1365

## CHARACTERIZATION CURVES

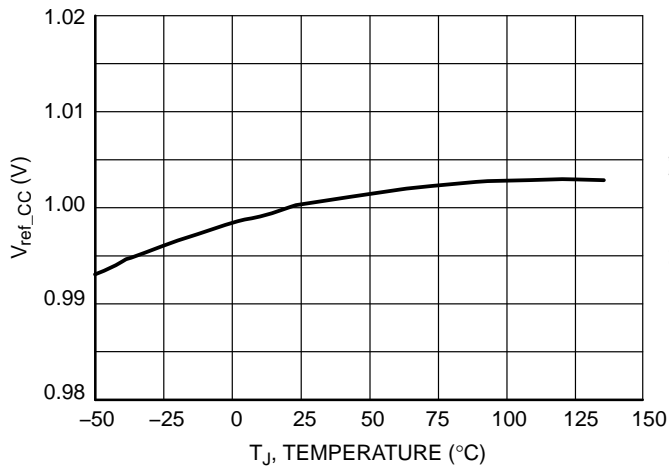

**Figure 17. Internal Voltage Reference for Constant Current Regulation versus Temperature**

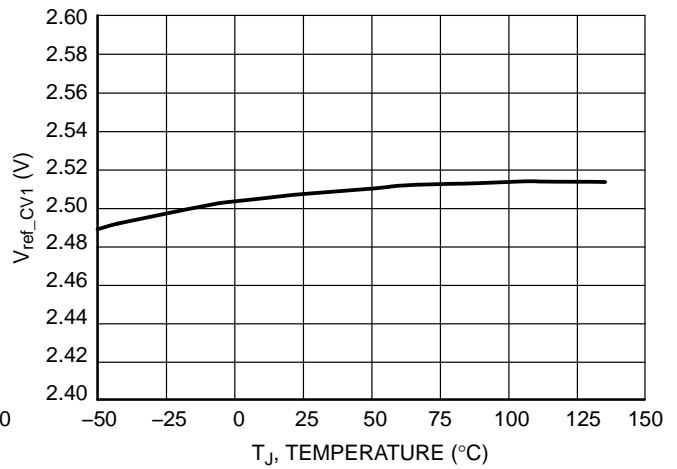

**Figure 18. Internal Voltage Reference for Constant Voltage Regulation versus Temperature**

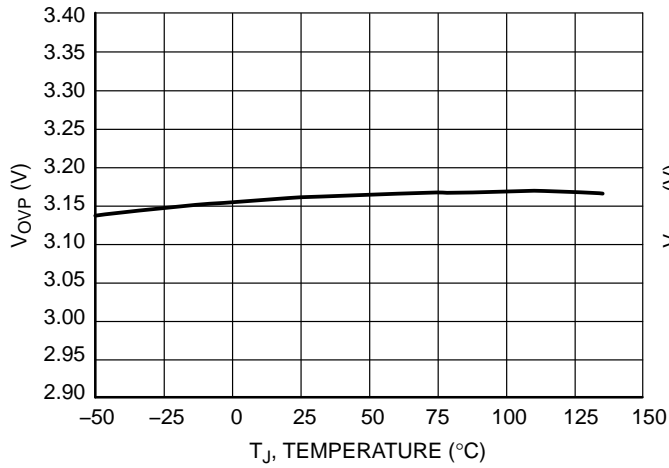

**Figure 19. Output Over Voltage Level versus Temperature**

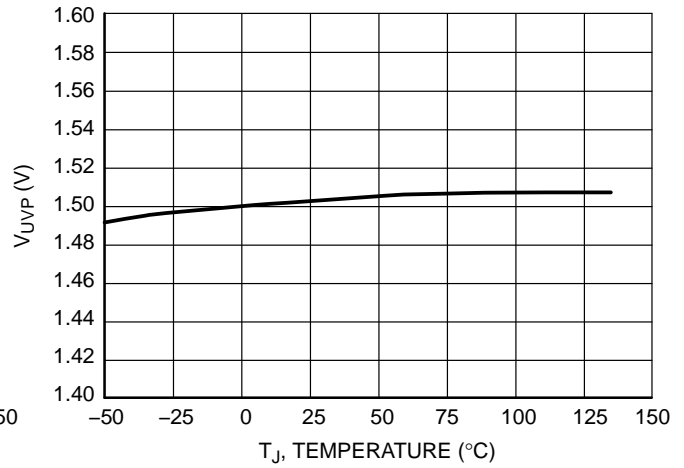

**Figure 20. Output Under Voltage Level versus Temperature**

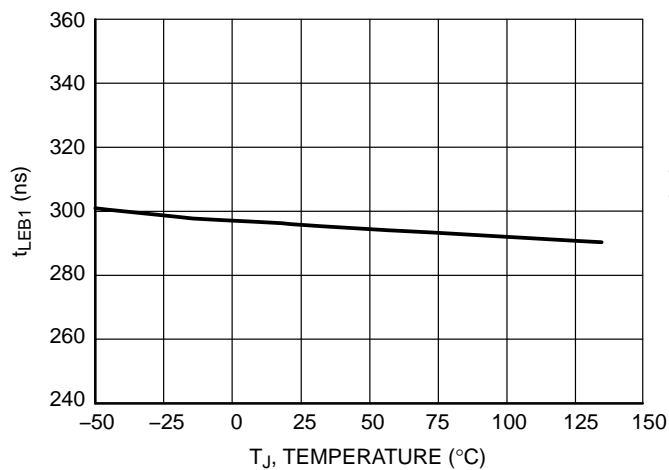

**Figure 21. Cycle-by-Cycle Leading Edge Blanking Duration versus Temperature**

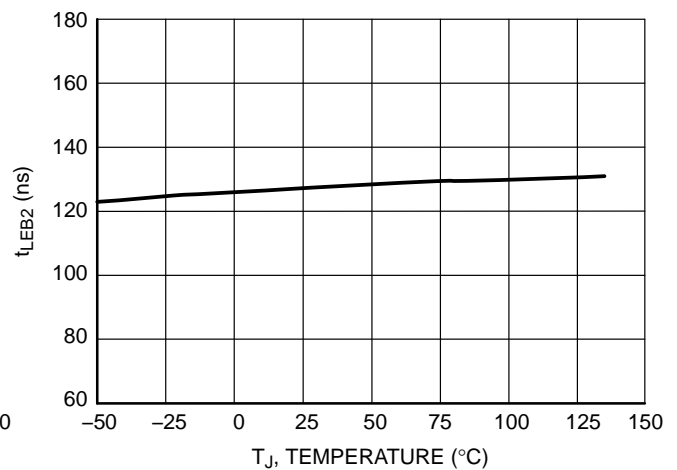

**Figure 22. Leading Edge Blanking Duration for V<sub>CS(stop)</sub> Level versus Temperature**

# NCP1360, NCP1365

## CHARACTERIZATION CURVES

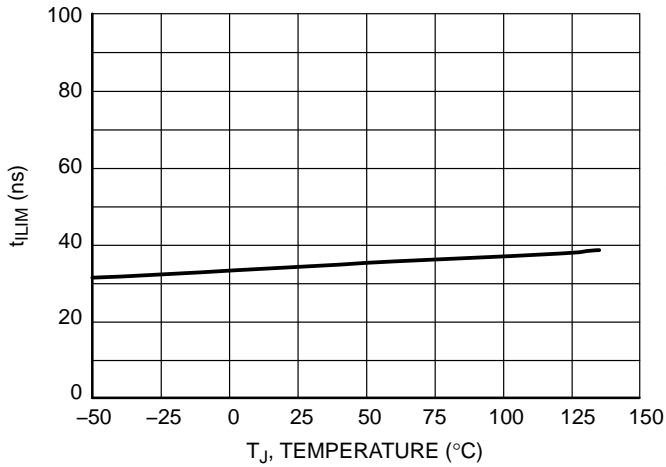

**Figure 23. Cycle-by-Cycle Current Sense Propagation Delay versus Temperature**

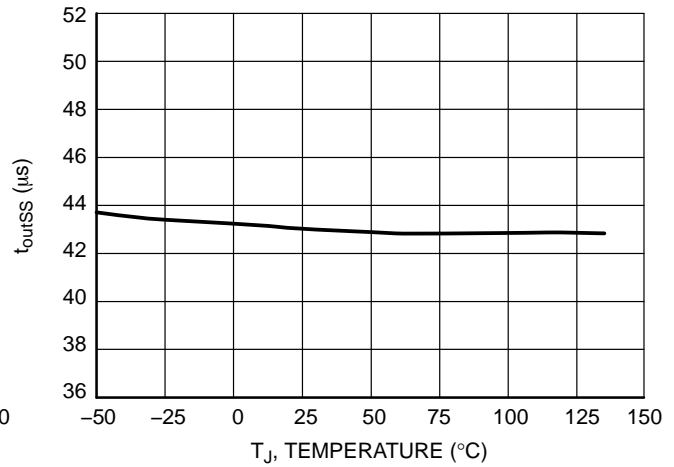

**Figure 24. Timeout After Last Demagnetization Transition in Soft-Start versus Temperature**

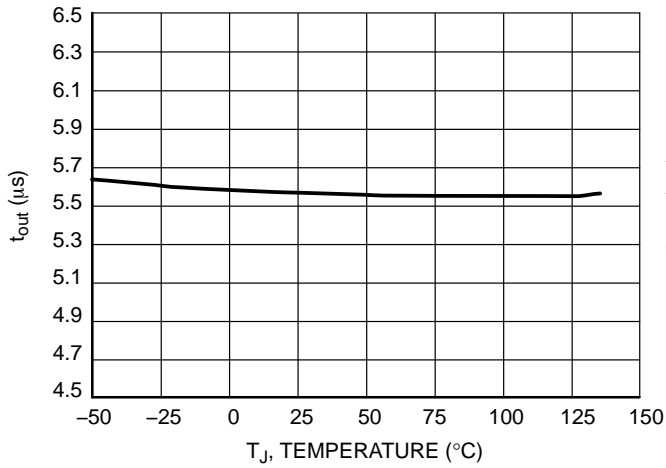

**Figure 25. Timeout After Last Demagnetization Transition versus Temperature**

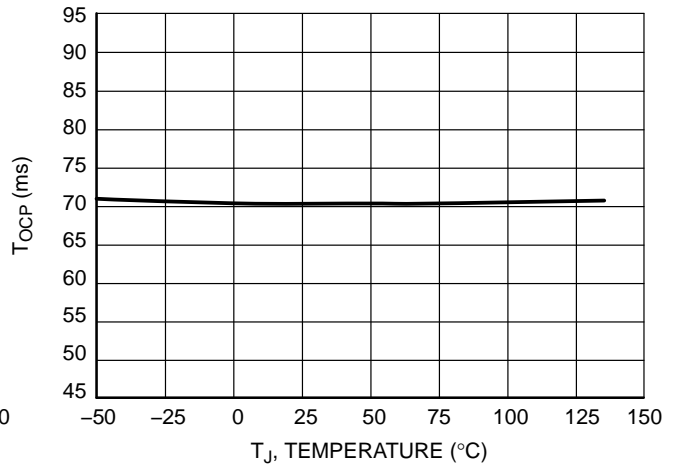

**Figure 26. Timer Delay Before Latching in Overload Condition versus Temperature**

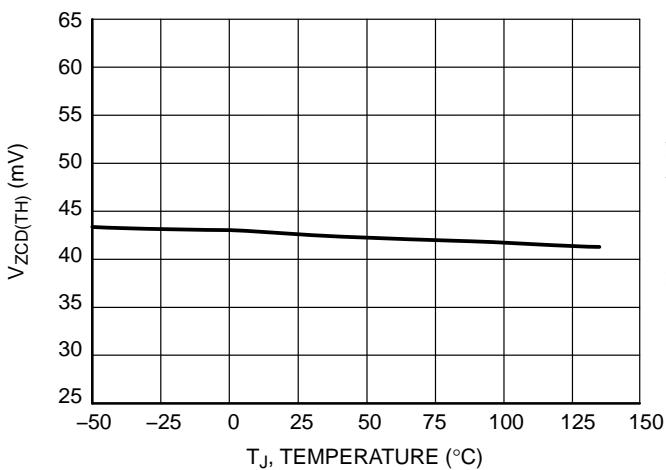

**Figure 27. Zero Voltage Detection Threshold Voltage versus Temperature**

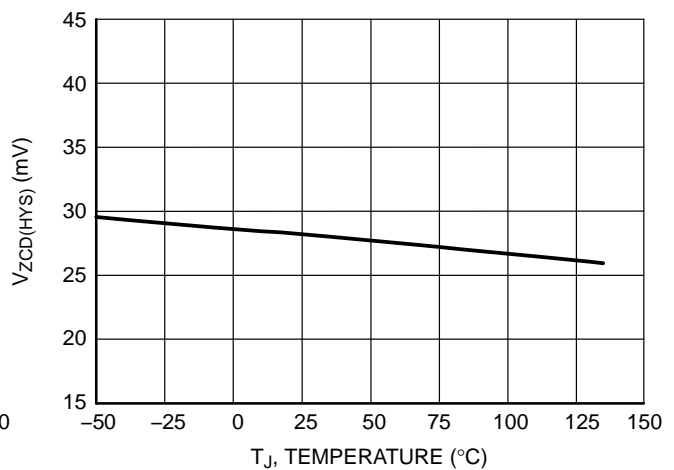

**Figure 28. Zero Voltage Detection Hysteresis versus Temperature**

# NCP1360, NCP1365

## CHARACTERIZATION CURVES

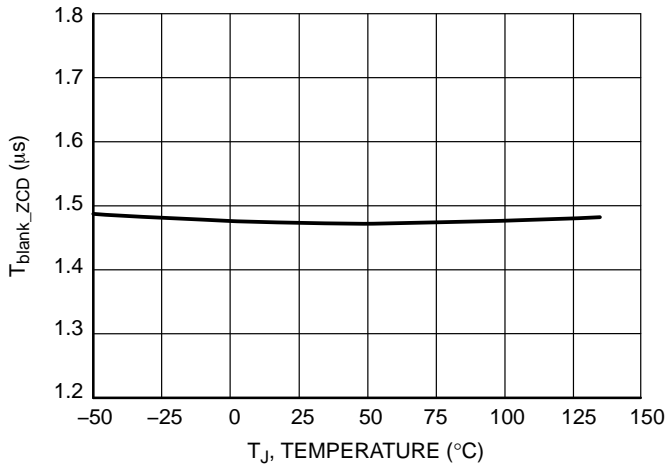

Figure 29. Blanking Delay for ZCD Detection versus Temperature

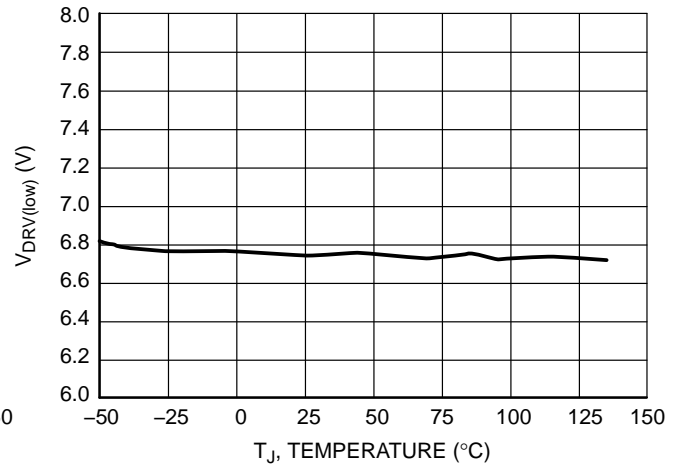

Figure 30. V<sub>DRV(low)</sub> versus Temperature

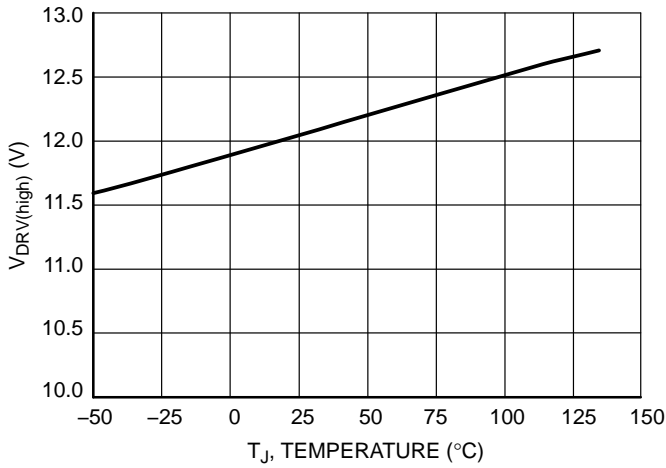

Figure 31. V<sub>DRV(high)</sub> versus Temperature

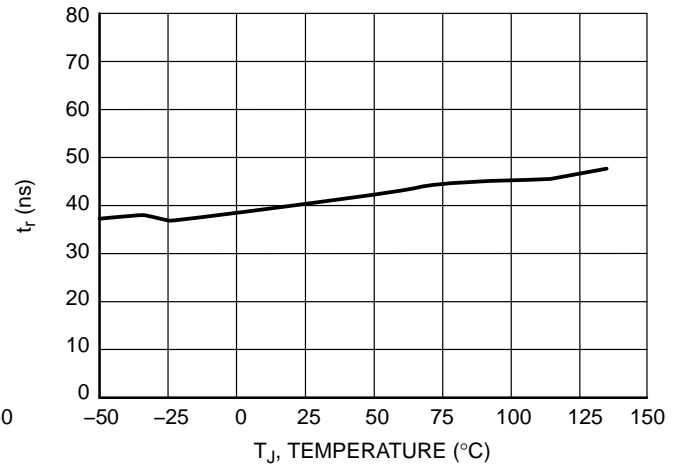

Figure 32. Gate Drive Rise Time versus Temperature

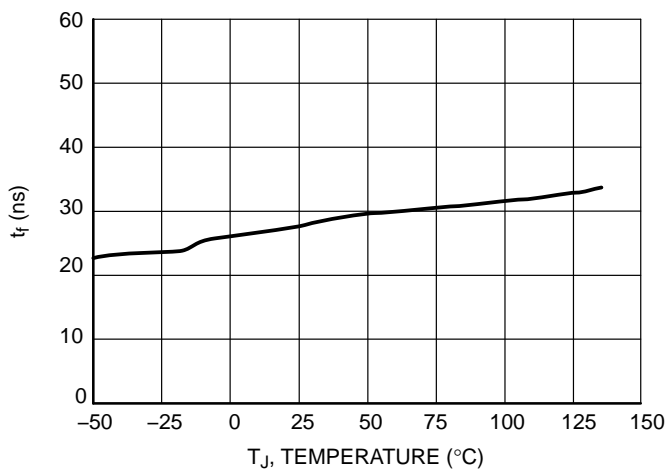

Figure 33. Gate Drive Fall Time versus Temperature

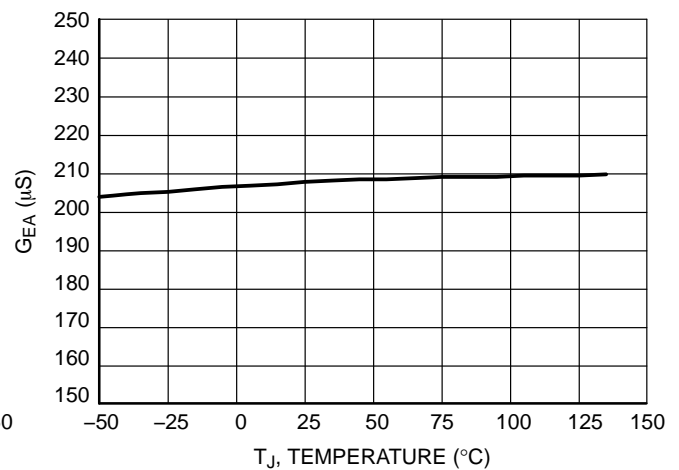
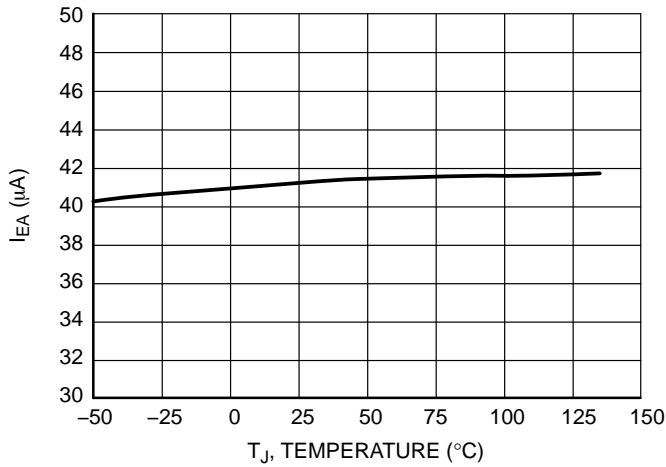

Figure 34. Error Amplifier Gain versus Temperature

# NCP1360, NCP1365

## CHARACTERIZATION CURVES



**Figure 35. Error Amplifier Max. Source Capability versus Temperature**

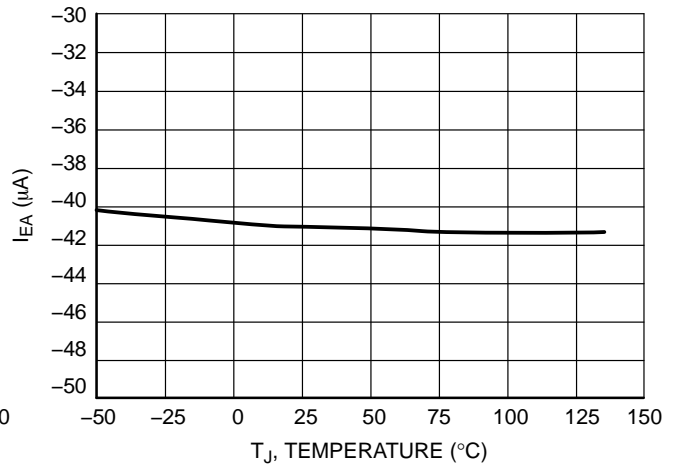

**Figure 36. Error Amplifier Max. Sink Capability versus Temperature**

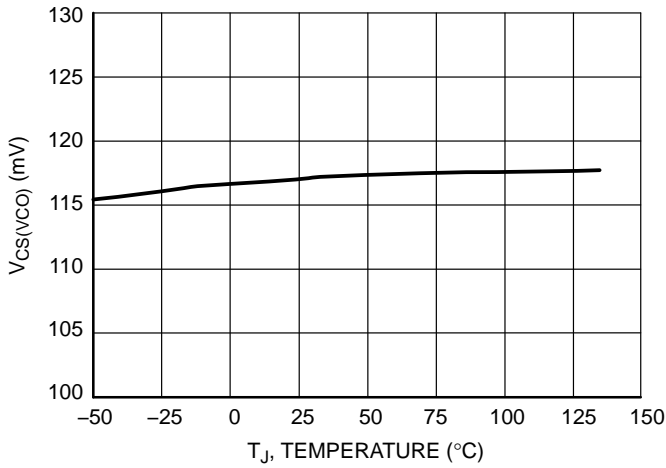

**Figure 37. Minimum or Frozen Peak Current on CS Pin versus Temperature**

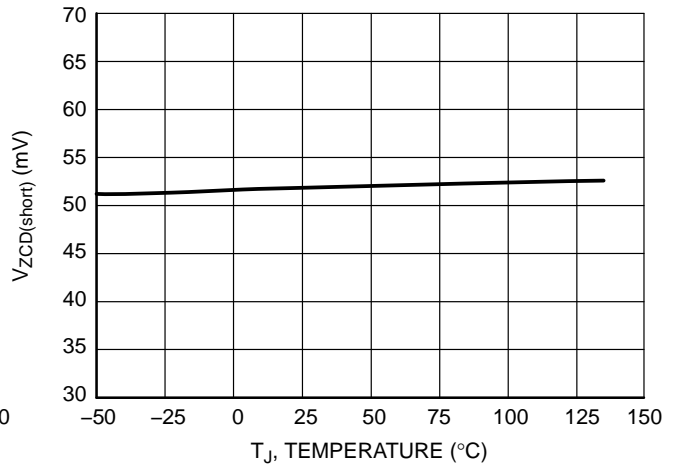

**Figure 38. Threshold Level for Detecting Output or Aux. Winding Short versus Temperature**

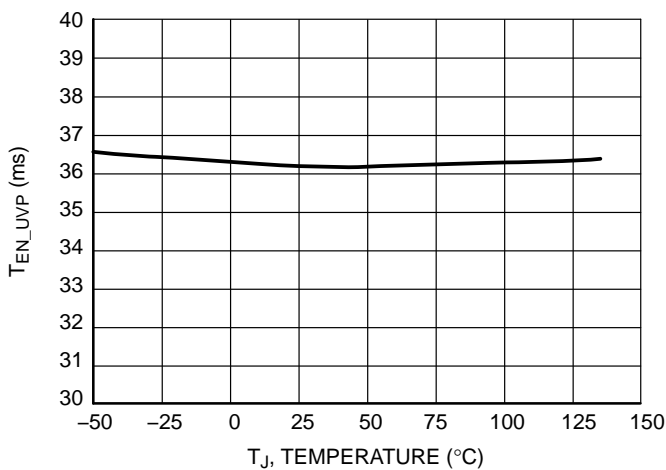

**Figure 39. Startup Blanking Time for UVP Detection versus Temperature**

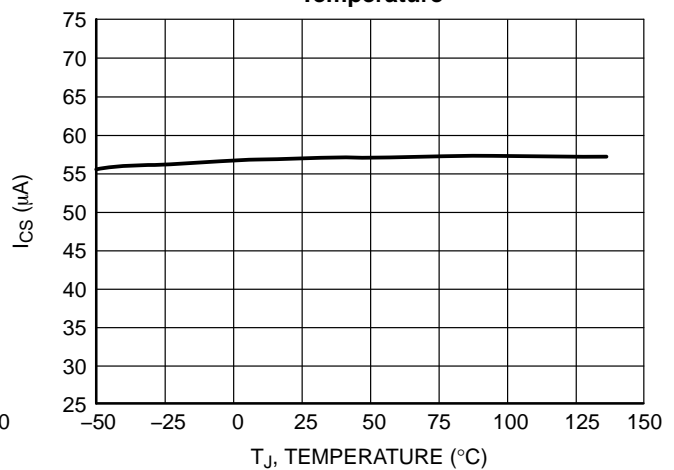

**Figure 40. Pull-up Current Source for Detecting Open or Short on CS Pin versus Temperature**

# NCP1360, NCP1365

## CHARACTERIZATION CURVES

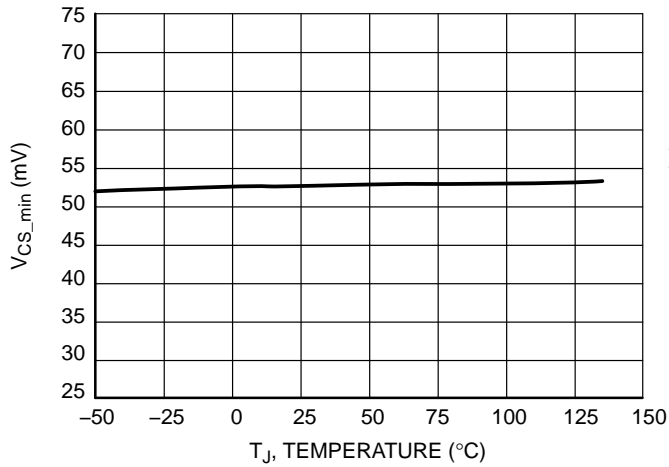

**Figure 41. CS Pin Short Detection Threshold versus Temperature**

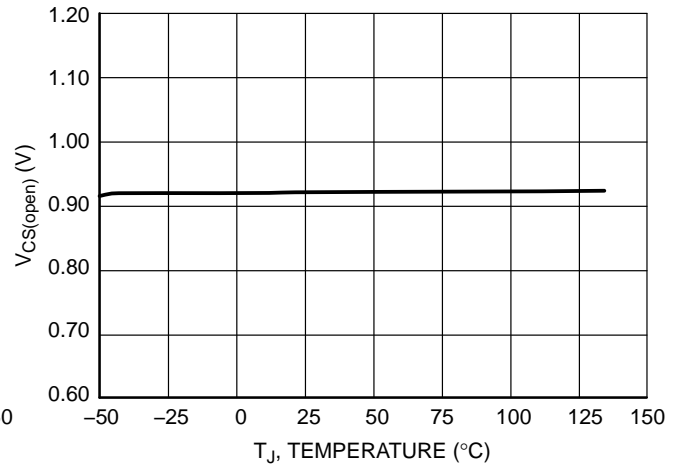

**Figure 42. CS Pin Open Detection Threshold versus Temperature**



APPLICATION INFORMATION

The NCP1365/60 is a flyback power supply controller providing a means to implement primary side constant-voltage and constant-current regulation. This technique does not need a secondary side feedback circuitry, associated bias current and an opto-coupler. NCP1365/60 implements a current-mode architecture operating in quasi-resonant mode. The controller prevents valley-jumping instability and steadily locks out in a selected valley as the power demand goes down. As long as the controller is able to detect a valley, the new cycle or the following drive remains in a valley. Due to a dedicated valley detection circuitry operating at any line and load conditions, the power supply efficiency will always be optimized. In order to prevent any high switching frequency two frequency clamp options are available.

- Quasi-Resonance Current-mode operation:** implementing quasi-resonance operation in peak current-mode control optimizes the efficiency by switching in the valley of the MOSFET drain-source voltage. Thanks to a proprietary circuitry, the controller locks-out in a selected valley and remains locked until the input voltage significantly changes. Only the four first valleys could be locked out. When the load current diminishes, valley switching mode of operation is kept but without valley lock-out. Valley-switching operation across the entire input/output conditions brings efficiency improvement and lets the designer build higher-density converters.
- Frequency Clamp:** As the frequency is not fixed and dependent on the line, load and transformer specifications, it is important to prevent switching frequency runaway for applications requiring maximum switching frequencies up to 90 kHz or 130 kHz. Two frequency clamp options at 80 kHz or 110 kHz are available for this purpose. In case frequency clamp is not needed, a specific version of the 1365/60 exists in which the clamp is deactivated.
- Primary Side Constant Current Regulation:** Battery charging applications request constant current regulation. NCP1360/65 controls and regulates the output current at a constant level regardless of the input and output voltage conditions. This function offers tight over power protection by estimating and limiting the maximum output current from the primary side, without any particular sensor.
- Primary Side Constant Voltage Regulation:** By monitoring the auxiliary winding voltage on the primary side, it is possible to determine the end of the transformer demagnetization in order to indirectly measure the output voltage. The end of the auxiliary winding demagnetization corresponds to that of the secondary winding affected by the transformer turns ratio. This auxiliary voltage value captured at this

moment will be used to build the primary-side peak current setpoint in order to control the output voltage.

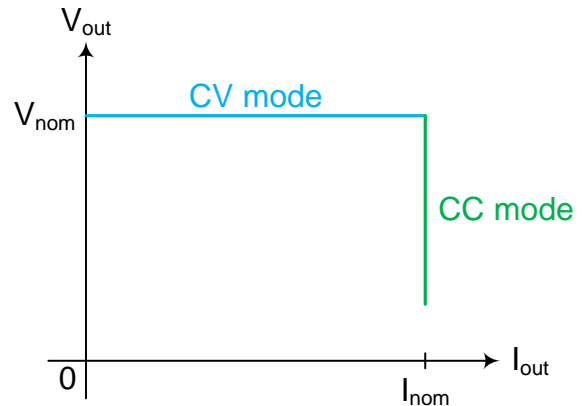

Figure 43. Constant-Voltage & Constant-Current Mode

- Soft-Start:** 4 ms internal fixed soft start guarantees a peak current starting from zero to its nominal value with smooth transition in order to prevent any overstress on the power components at each startup.
- Cycle-by-Cycle peak current limit:** If the max peak current reaches the  $V_{LIM}$  level, the over current protection timer is enabled and starts counting. If the overload lasts  $T_{OCP}$  delay, then the fault is latched and the controller stops immediately driving the power MOSFET. The controller enters in a double hiccup mode before autorecovering with a new startup cycle.
- V<sub>CC</sub> Over Voltage Protection:** If the  $V_{CC}$  voltage reaches the  $V_{CC(OVP)}$  threshold the controller enters in latch mode. Thus it stops driving pulse on  $DRV$  pin:
  - A & C version – (Latched  $V_{CC(OVP)}$ ):**  $V_{CC}$  capacitor is internally discharged to the  $V_{CC(Clamp)}$  level with a very low power consumption: the controller is completely disabled. Resuming operation is possible by unplugging the line in order to releasing the internal  $V_{CC}$  thyristor with a  $V_{CC}$  current lower than the  $I_{CC(Clamp)}$ .
  - B version – (Autorecovery):** it enters in double hiccup mode before resuming operation.
- Winding Short-Circuit Protection:** An additional comparator senses the  $CS$  signal and stops the controller if  $V_{CS}$  reaches  $V_{LIM}+50\%$  (after a reduced LEB:  $t_{LEB2}$ ). Short circuit protection is enabled only if 4 consecutive pulses reach  $SCP$  level. This small counter prevents any false triggering of short circuit protection during surge test for instance. This fault is latched and operations will be resumed like in a case of  $V_{CC}$  Over Voltage Protection.

- V<sub>out</sub> Over Voltage Protection:** if the internally–built output voltage becomes higher than  $V_{OVP}$  level ( $V_{ref\_CV1} + 26\%$ ) a fault is detected.
  - A & C version:** This fault is latched and operations are resumed like in the **V<sub>CC</sub> Over Voltage Protection** case.
  - B version:** the part enters in double hiccup mode before resuming operations.
- V<sub>out</sub> Under Voltage Protection:** After each circuit power on sequence,  $V_{out}$  UVP detection is enabled only after the startup timer  $T_{EN\_UVP}$ . This timer ensures that the power supply is able to fuel the output capacitor before checking the output voltage in on target. After this startup blanking time, UVP detection is enabled and monitors the Output voltage level. When the power supply is running in constant–current mode and when the output voltage falls below  $V_{UVP}$  level, the controller stops sending drive pulses and enters a double hiccup mode before resuming operations (A & B version), or latches off (C version).
- V<sub>s</sub>/ZCD Pin Short Protection:** at the beginning of each off–time period, the  $V_s/ZCD$  pin is tested to check whether it is shorted or left open. In case a fault is detected, the controller enters in a double hiccup mode before resuming operations.
- Temperature Shutdown:** if the junction temperature reaches the  $T_{SHTDN}$  level, the controller stop driving the

power mosfet until the junction temperature decreases by  $T_{SHTDN(HYS)}$ , then the operation is resumed after a double hiccup mode.

**Startup Operation**

The high–voltage startup current source is connected to the bulk capacitor via the *HV* pin, it charges the  $V_{CC}$  capacitor. During startup phase, it delivers 100  $\mu$ A to fuel the  $V_{CC}$  capacitor. When  $V_{CC}$  pin reaches  $V_{CC(on)}$  level, the NCP1360/65 is enabled. Before sending the first drive pulse to the power MOSFET, the *CS* pin has been tested for an open or shorted situation. If *CS* pin is properly wired, then the controller sends the first drive pulse to the power MOSFET. After sending these first pulses, the controller checks the correct  $V_s/ZCD$  pin wiring. Considering the  $V_s/ZCD$  pin properly wired, the controller engages a softstart sequence. The softstart sequence controls the max peak current from the minimal frozen primary peak current ( $V_{CS(VCO)} = 120$  mV: 15% of  $V_{LLIM}$ ) to the nominal pulse width by smoothly increasing the level.

Figure 44 illustrates a standard connection of the *HV* pin to the bulk capacitor. If the controller is in a latched fault mode (ex  $V_{CC\_OVP}$  has been detected), the power supply will resume the operation after unplugging the converter from the ac line outlet. Due the extremely low controller consumption in latched mode, the release of the latch could be very long. The unplug duration for releasing the latch will be dependent on the bulk capacitor size.

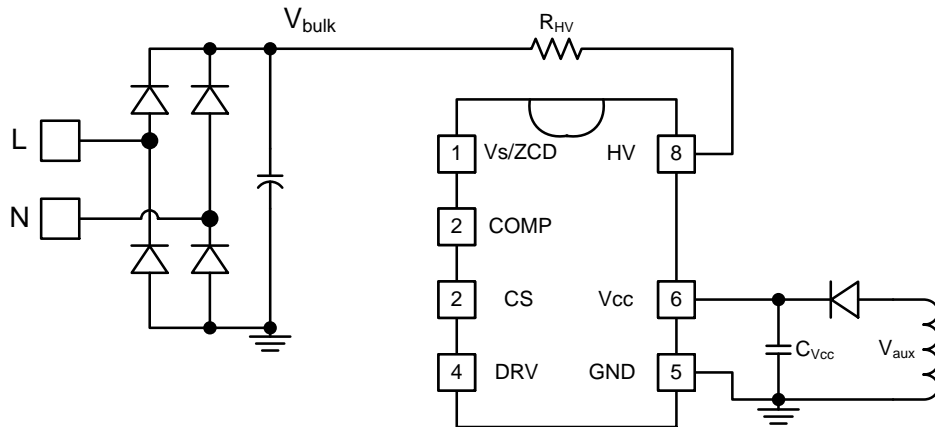

Figure 44. HV Startup Connection to the Bulk Capacitor

The following calculation illustrates the time needed for releasing the latch state:

$$t_{unplug} > \frac{C_{bulk} V_{in\_ac} \sqrt{2}}{I_{HV}} \quad (\text{eq. 1})$$

For the following typical application with a 10  $\mu$ F bulk capacitor and a wide mains input range, in the worst case the power supply needs to be unplug at least for 38 seconds @ 265 V ac and 12 seconds @ 85 Vac. It is important to note that the previous recommendation is no longer valid with the B version, as all the faults are set to autorecovery mode only.

**Protecting the Controller Against Negative Spikes**

As with any controller built upon a CMOS technology, it is the designer’s duty to avoid the presence of negative spikes on sensitive pins. Negative injection has the bad habit to forward–bias the controller substrate and can induce erratic behaviors. Sometimes, the injection can be so strong that internal parasitic SCRs are triggered and latch the controller. The *HV* pin can be the problem in certain circumstances. During the turn–off sequence, e.g. when the user unplugs the power supply, the controller is still fed by its  $V_{CC}$  capacitor and keeps activating the MOSFET ON and

OFF with a peak current limited by  $R_{sense}$ . Unfortunately, if the quality factor  $Q$  of the resonating network formed by  $L_p$  and  $C_{bulk}$  is high (e.g. the MOSFET  $R_{DS(on)} + R_{sense}$  are small), conditions are met to make the circuit resonate and a negative ringing can potentially appear at the  $HV$  pin.

Simple and inexpensive cures exist to prevent the internal parasitic SCR activation. One of them consist of inserting a resistor in series with the  $HV$  pin to keep the negative current at the lowest when the bulk swings negative (Figure 44).

Another option (Figure 45) consists of connecting the  $HV$  pin directly to the line or neutral input via a high-voltage diode. This configuration offers the benefits to release a latch state immediately after unplugging the power supply from the mains outlet. There is no delay for resetting the controller as there no capacitor keeps the  $HV$  bias.

$R_{HV}$  resistor value must be sized as follow in order to guarantee a correct behavior of the  $HV$  startup in the worst case conditions:

$$R_{HV} < \frac{V_{in,ac\_min} \sqrt{2} - V_{HV(min)\_max}}{I_{HV\_max}} \quad (eq. 2)$$

Where:

- $V_{in,ac\_min}$  is minimal input voltage, for example 85 V ac for universal input mains.
- $V_{HV(min)\_max}$  is the worst case of the minimal input voltage needed for the  $HV$  startup current source (25 V-max).
- $I_{HV\_max}$  is the maximum current delivered by the  $HV$  startup current source (150  $\mu$ A-max)

With this typical example

$$R_{HV} < \frac{85\sqrt{2} - 25}{150 \mu} = 633 \text{ k}\Omega,$$

then any value below this one will be ok.

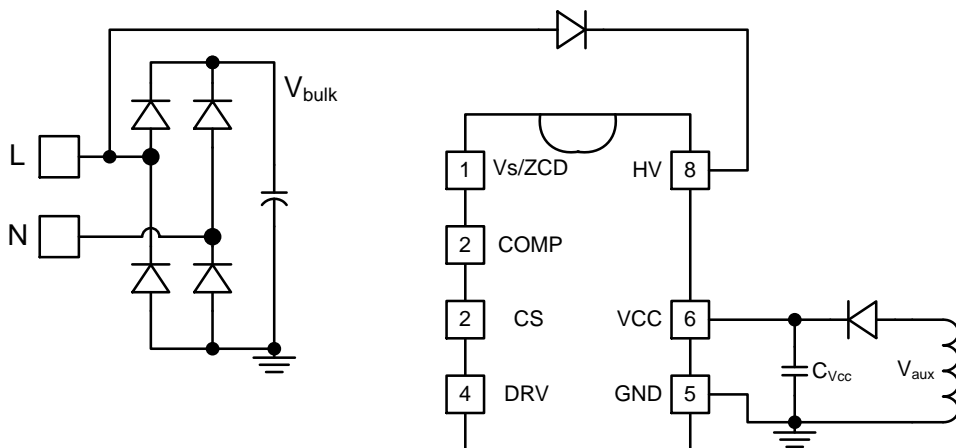

Figure 45. Recommended HV Startup Connection for Fast Release after a Latched Fault

**Primary Side Regulation: Constant Current Operation**

Figure 46 portrays idealized primary and secondary transformer currents of a flyback converter operating in Discontinuous Conduction Mode (DCM).

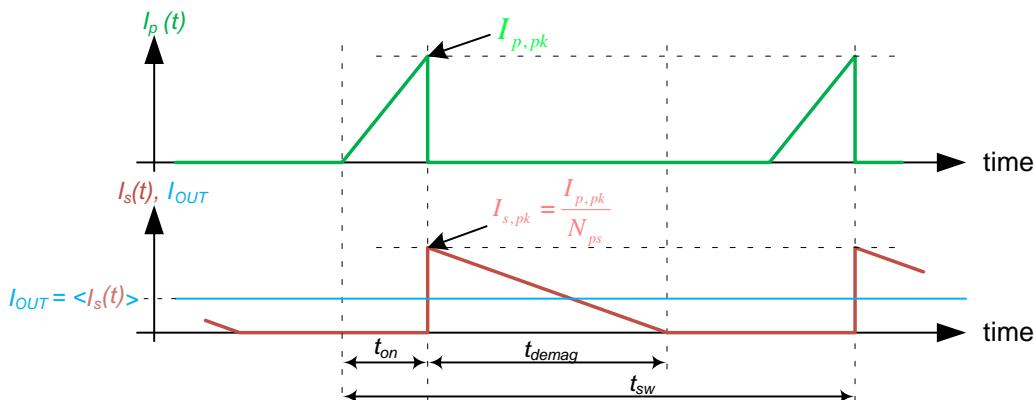

Figure 46. Primary and Secondary Transformer Current Waveforms

When the primary power MOSFET is turned on, the primary current is illustrated by the green curve of Figure 46. When the power MOSFET is turned off the primary side current drops to zero and the current into the secondary winding immediately rises to its peak value equal to the primary peak current divided by the primary to secondary turns ratio. This is an ideal situation in which the leakage inductance action is neglected.

The output current delivered to the load is equal to the average value of the secondary winding current, thus we can write:

$$I_{out} = \langle i_{sec}(t) \rangle = \frac{I_{p,pk} t_{demag}}{2N_{ps} t_{sw}} \quad (\text{eq. 3})$$

Where:

- $t_{sw}$  is the switching period
- $t_{demag}$  is the demagnetizing time of the transformer
- $N_{ps}$  is the secondary to primary turns ratio, where  $N_p$  and  $N_s$  are respectively the transformer primary and secondary turns:

$$N_{ps} = \frac{N_s}{N_p} \quad (\text{eq. 4})$$

- $I_{p,pk}$  is the magnetizing peak current sensed across the sense resistor on CS pin:

$$I_{p,pk} = \frac{V_{CS}}{R_{sense}} \quad (\text{eq. 5})$$

Internal constant current regulation block is building the constant current feedback information as follow:

$$V_{FB\_CC} = V_{ref\_CC} \frac{t_{sw}}{t_{demag}} \quad (\text{eq. 6})$$

As the controller monitors the primary peak current via the sense resistor and due to the internal current setpoint divider ( $K_{Comp}$ ) between the CS pin and the internal feedback information, the output current could be written as follow:

$$I_{out} = \frac{V_{ref\_CC}}{8N_{ps}R_{sense}} \quad (\text{eq. 7})$$

The output current value is set by choosing the sense resistor value:

$$R_{sense} = \frac{V_{ref\_CC}}{8N_{ps}I_{out}} \quad (\text{eq. 8})$$

### Primary Side Regulation: Constant Voltage Operation

In primary side constant voltage regulation, the output voltage is sensed via the auxiliary winding. During the on-time period, the energy is stored in the transformer gap. During the off-time this energy stored in the transformer is delivered to the secondary and auxiliary windings.

As illustrated by Figure 47, when the transformer energy is delivered to the secondary, the auxiliary voltage sums the output voltage scaled by the auxiliary and secondary turns ratios and the secondary forward diode voltage. This secondary forward diode voltage could be split in two elements: the first part is the forward voltage of the diode ( $V_f$ ), and the second is related to the dynamic resistance of the diode multiplied by secondary current ( $R_d \cdot I_s(t)$ ). Where this second term will be dependant of the load and line conditions.

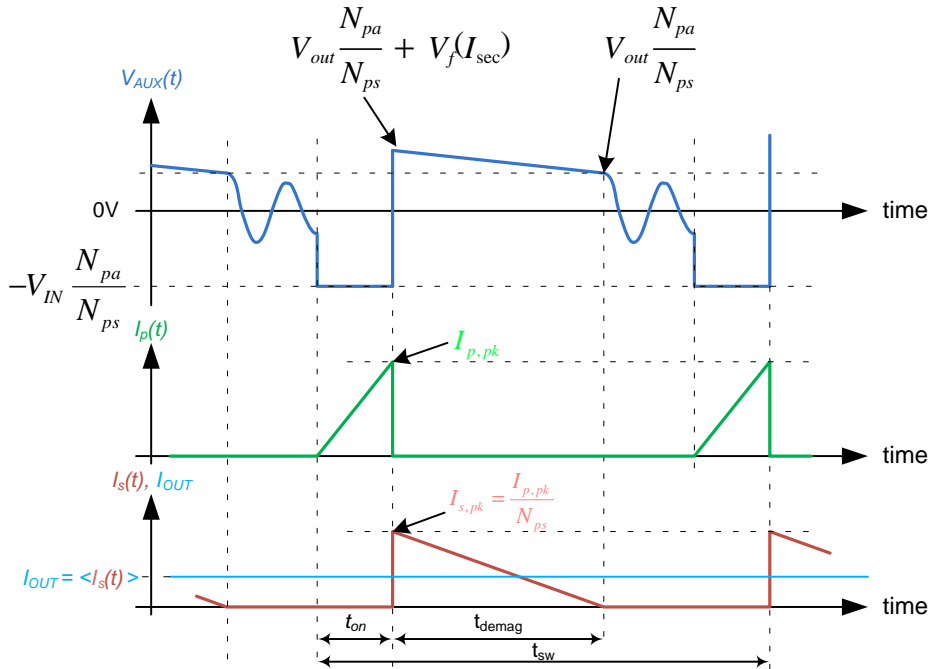

Figure 47. Typical Idealized Waveforms of a Flyback Transformer in DCM

To reach an accurate primary-side constant-voltage regulation, the controller detects the end of the demagnetization time and precisely samples output voltage level seen on the auxiliary winding. As this moment coincides with the secondary-side current equal to zero, the diode forward voltage drop becomes independent from the loading conditions.

Thus when the secondary current  $I_s(t)$  reaches zero ampere, the auxiliary is sensed:

$$V_{aux} = V_{out} \frac{N_{pa}}{N_{ps}} \quad (\text{eq. 9})$$

Where:  $N_{pa}$  is the auxiliary to primary turns ratio, where  $N_p$  &  $N_a$  are respectively the primary and auxiliary turns:

$$N_{pa} = \frac{N_a}{N_p} \quad (\text{eq. 10})$$

Figure 48 illustrates how the constant voltage feedback has been built. The auxiliary winding voltage must be scaled

down via the resistor divider to  $V_{ref\_CV1}$  level before building the constant voltage feedback error.

$$V_{ref\_CV1} = \frac{R_{s2}}{R_{s1} + R_{s2}} V_{aux} \quad (\text{eq. 11})$$

By inserting Equation 9 into Equation 11 we obtain the following equation:

$$V_{ref\_CV1} = \frac{R_{s2}}{R_{s1} + R_{s2}} \frac{N_{pa}}{N_{ps}} V_{out} \quad (\text{eq. 12})$$

Once the sampled  $V_{out}$  is applied to the negative input terminal of the operational transconductance amplifier (OTA) and compared to the internal voltage reference an adequate voltage feedback is built. The OTA output being pinned out, it is possible to compensate the converter and adjust step load response to what the project requires.

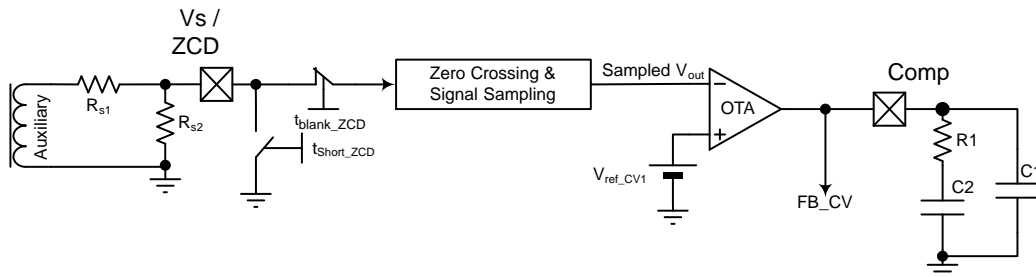

Figure 48. Constant Voltage Feedback Arrangement

When the power MOSFET is released at the end of the on time, because of the transformer leakage inductance and the drain lumped capacitance some voltage ringing appears on the drain node. These voltage ringings are also visible on the auxiliary winding and could cheat the controller detection circuits. To avoid false detection operations, two protecting circuits have been implemented on the  $V_s/ZCD$  pin (see Figure 49):

1. An internal switch grounds the  $V_s/ZCD$  pin during  $t_{on} + t_{short\_ZCD}$  in order to protect the pin from negative voltage.
2. In order to prevent any misdetection from the zero crossing block an internal switch disconnects  $V_s/ZCD$  pin until  $t_{blank\_ZCD}$  time (1.5  $\mu$ s typ.) ends.

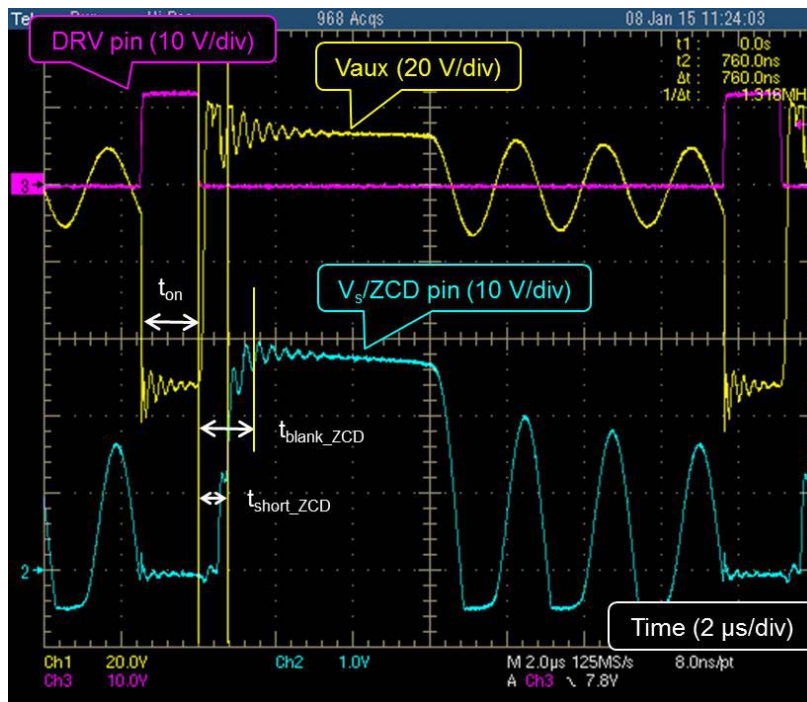

Figure 49.  $V_s/ZCD$  Pin Waveforms

**Constant-Current and Constant-Voltage Overall Regulation:**

As already presented in the two previous paragraphs, the controller integrates two different feedback loops: the first one deals with the constant-current regulation scheme while the second one builds the constant-voltage regulation. One of the two feedback paths sets the primary peak current into the transformer. During startup phase, however, the peak current is controlled by the soft-start.

**Zero Current Detection**

The NCP1365 integrates a quasi-resonant (QR) flyback controller. The power switch turn-off of a QR converter is determined by the peak current whose value depends on the feedback loop. The switch restart event is determined by the transformer demagnetization end. The demagnetization end

is detected by monitoring the transformer auxiliary winding voltage. Turning on the power switch once the transformer is demagnetized (or reset) reduces turn-on switching losses. Once the transformer is demagnetized, the drain voltage starts ringing at a frequency determined by the transformer magnetizing inductance and the drain lumped capacitance, eventually settling at the input voltage value. A QR controller takes advantage of the drain voltage ringing and turns on the power switch at the drain voltage minimum or “valley” to reduce turn-on switching losses and electromagnetic interference (EMI).

As sketched by Figure 50, a valley is detected once the ZCD pin voltage falls below the QR flyback demagnetization threshold,  $V_{ZCD(TH)}$ , typically 45 mV. The controller will switch once the valley is detected or increment the valley counter depending on FB voltage.

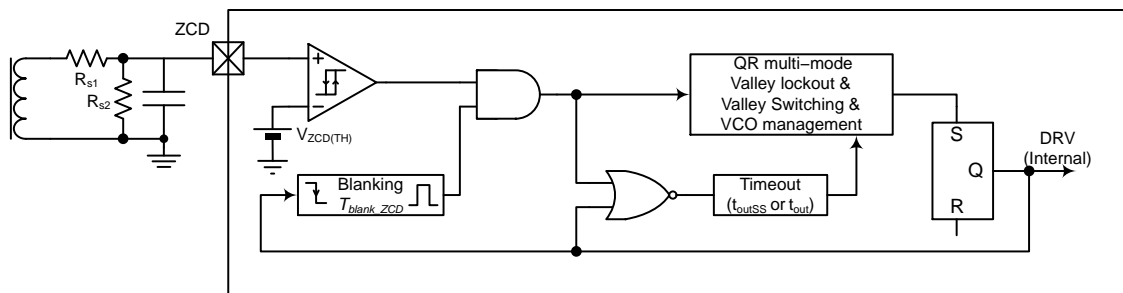

Figure 50. Valley Lockout Detection Circuitry internal Schematic

**Timeout**

The *ZCD* block actually detects falling edges of the auxiliary winding voltage applied to the *ZCD* pin. At start-up or during other transient phases, the *ZCD* comparator may be unable to detect such an event. Also, in the case of extremely damped oscillations, the system may not succeed in detecting all the valleys required by valley lockout operation (VLO, see next section). In this condition, the NCP1365 ensures continued operation by incorporating a maximum timeout period that resets itself when a demagnetization phase is properly detected. In case the ringing signal is too weak or heavily damped, the timeout signal supersedes the *ZCD* signal for the valley counter. Figure 50 shows the timeout period generator circuit schematic. The timeout duration,  $t_{out}$ , is set to 5.5  $\mu$ s (typ.).

During startup, the output voltage is still low, leading to long demagnetization phase, difficult to detect since the auxiliary winding voltage is small as well. In this condition, the  $t_{out}$  timeout is generally shorter than the inductor demagnetization period and if used to restart a switching cycle, it can cause continuous current mode (CCM) operation for a few cycles until the voltage on the *ZCD* pin is high enough for proper valleys detection. A longer timeout period,  $t_{outSS}$ , (typically 44  $\mu$ s) is therefore set during soft-start to prevent CCM operation.

In VLO operation, the timeout occurrences are counted instead of valleys when the drain-source voltage oscillations are too damped to be detected. For instance, assume the circuit must turn on at the third valley and the *ZCD* ringing only enables the detection of:

- Valleys #1 to #2: the circuit generates a *DRV* pulse  $t_{out}$  (steady-state timeout delay) after valley #2 detection.

- Valley #1: the timeout delay must run twice so that the circuit generates a *DRV* pulse 10  $\mu$ s ( $2 * t_{out}$  typ.) after valley #1 detection.

**Valley LockOut (VLO) and Frequency Foldback (FF)**

The operating frequency of a traditional Quasi-Resonant (QR) flyback controller is inversely proportional to the system load. In other words, a load reduction increases the operating frequency. A maximum frequency clamp can be useful to limit the operating frequency range. However, when associated with a valley-switching circuit, instabilities can arise because of the discrete frequency jumps. The controller tends to hesitate between two valleys and audible noise can be generated

To avoid this issue, the NCP1360/65 incorporates a proprietary valley lockout circuitry which prevents so-called valley jumping. Once a valley is selected, the controller stays locked in this valley until the input level or output power changes significantly. This technique extends QR operation over a wider output power range while maintaining good efficiency and naturally limiting the maximum operating frequency.

The operating valley (from 1<sup>st</sup> to 4<sup>th</sup> valley) is determined by the internal feedback level (*FB* node on Figure 4). As *FB* voltage level decreases or increases, the valley comparators toggle one after another to select the proper valley.

The decimal counter increases each time a valley is detected. The activation of an “n” valley comparator blanks the “n-1” or “n+1” valley comparator output depending if  $V_{FB}$  decreases or increases, respectively. Figure 51 shows a typical frequency characteristic obtained at low line in a 10 W charger.

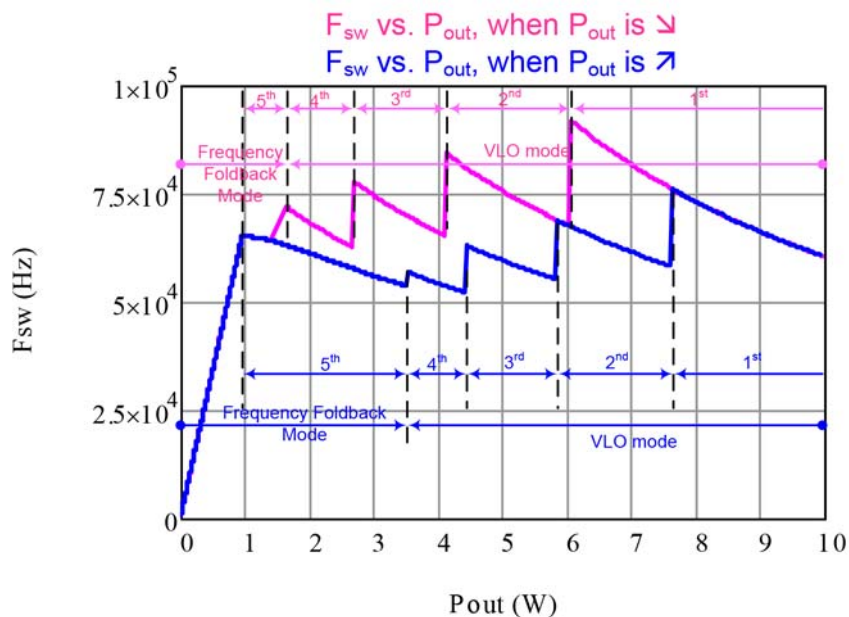

Figure 51. Typical Switching Frequency versus Output Power Relationship in a 10 W Adapter

## NCP1360, NCP1365

When an “n” valley is asserted by the valley selection circuitry, the controller locks in this valley until the  $FB$  voltage decreases to the lower threshold (“n+1” valley activates) or increases to the “n valley threshold” + 600 mV (“n-1” valley activates). The regulation loop adjusts the

peak current to deliver the necessary output power at the valley operating point. Each valley selection comparator features a 600 mV hysteresis that helps stabilize operation despite the  $FB$  voltage swing produced by the regulation loop.

**Table 1. VALLEY FB THRESHOLD ON CONSTANT VOLTAGE REGULATION**

FB Falling		FB Rising	
1 <sup>st</sup> to 2 <sup>nd</sup> valley	2.5 V	FF mode to 4 <sup>th</sup>	2.5 V
2 <sup>nd</sup> to 3 <sup>rd</sup> valley	2.3 V	4 <sup>th</sup> to 3 <sup>rd</sup> valley	2.7 V
3 <sup>rd</sup> to 4 <sup>th</sup> valley	2.1 V	3 <sup>rd</sup> to 2 <sup>nd</sup> valley	2.9 V
4 <sup>th</sup> to FF mode	1.9 V	2 <sup>nd</sup> to 1 <sup>st</sup> valley	3.1 V

### Frequency Foldback (FF)

As the output current decreases ( $FB$  voltage decreases), the valleys are incremented from 1 to 4. In case the fourth valley is reached, the  $FB$  voltage further decreases below 1.9 V and the controller enters the frequency foldback mode (FF). The current setpoint being internally forced to remain above 0.12 V (setpoint corresponding to  $V_{Comp} = 1.9$  V), the controller regulates the power delivery by modulating the switching frequency. When an output current increase causes  $FB$  to exceed the 2.5 V FF upper threshold (600-mV hysteresis), the circuit recovers  $VLO$  operation.

In frequency foldback mode, the system reduces the switching frequency by adding some dead-time after the 4<sup>th</sup> valley is detected. However, in order to keep the high

efficiency benefit inherent to the QR operation, the controller turns on again with the next valley after the dead time has ended. As a result, the controller will still run in valley switching mode even when the FF is enabled. This dead-time increases when the  $FB$  voltage decays. There is no discontinuity when the system transitions from  $VLO$  to FF and the frequency smoothly reduces as  $FB$  goes below 1.9 V.

The dead-time is selected to generate a 2  $\mu$ s dead-time when  $V_{Comp}$  is decreasing and crossing  $V_{HVCOI}$  (1.9 V typ.). At this moment, it can linearly go down to the minimal frequency limit ( $f_{VCO(min)} = 200, 600$  or 1200 Hz version are available). The generated dead-time is 1  $\mu$ s when  $V_{Comp}$  is increasing and crossing  $V_{HVCOI}$  (2.5 V typ.).

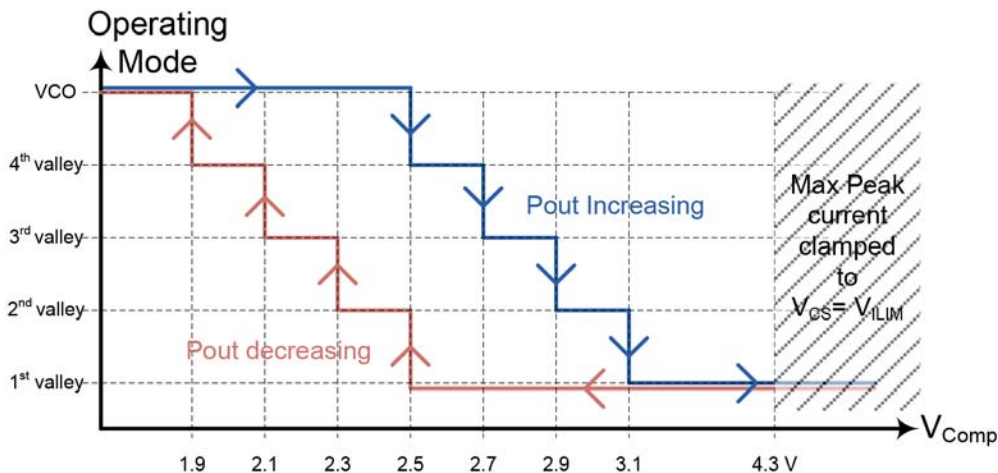

**Figure 52. Valley Lockout Threshold**

### Current Setpoint

As explained in this operating description, the current setpoint is affected by several functions. Figure 53 summarizes these interactions. As shown by this figure, the current setpoint is the output of the control law divided by  $K_{comp}$  (4 typ.). This current setpoint is clamped by the soft-start slope as long as the peak current requested by the  $FB\_CV$  or  $FB\_CC$  level are higher. The softstart clamp is

starting from the frozen peak current ( $V_{CS(VCO)} = 120$  mV typ.) to  $V_{ILIM}$  (0.8 V typ.) within 4 ms ( $t_{ss}$ ).

However, this internal  $FB$  value is also limited by the following functions:

- A minimum setpoint is forced that equals  $V_{CS(VCO)}$  (0.12 V, typ.)
- In addition, a second  $OCF$  comparator ensures that in any case the current setpoint is limited to  $V_{ILIM}$ .





## NCP1360, NCP1365

The end of output cable voltage level could be written as follows:

$$V_{out\_cable\_end}(t) = V_{out\_connector}(t) - R_{cable}I_{out}(t) \quad (\text{eq. 13})$$

$$V_{out\_cable\_end}(t) = V_{out} + V_{CBC}(t) \quad (\text{eq. 14})$$

$V_{out}$  corresponds to the nominal output level at no-load. It is independent of the output current level.

Then the cable compensation level could be determined as follow:

$$V_{CBC}(t) = CBC \frac{I_{out}(t)}{I_{out\_nom}} \quad (\text{eq. 15})$$

Where:

- ◆  $CBC$  corresponds to the cable compensation option selected (No comp, 150, 300 or 450 mV)
- ◆  $I_{out}(t)$  corresponds to the output current currently sunk by the load estimated on by the controller on the primary side.
- ◆  $I_{out\_nom}$  the nominal output current level of the power supply.

### Fault mode and Protection

- ◆  $CS$  pin: at each startup, a 55  $\mu\text{A}$  ( $I_{CS}$ ) current source pulls up the  $CS$  pin to disable the controller if the pin is left open or grounded. Then the controller enters in a double hiccup mode.

- ◆  $V_S/ZCD$  pin: after sending the first drive pulse the controller checks the correct wiring of  $V_S/ZCD$  pin: after the  $ZCD$  blanking time, if there is an open or short conditions, the controller enters in double hiccup mode.

**Thermal Shutdown:** An internal thermal shutdown circuit monitors the junction temperature of the IC. The controller is disabled if the junction temperature exceeds the thermal shutdown threshold ( $T_{SHDN}$ ), typically 150°C. A continuous  $V_{CC}$  hiccup is initiated after a thermal shutdown fault is detected. The controller restarts at the next  $V_{CC(on)}$  once the IC temperature drops below  $T_{SHDN}$  reduced by the thermal shutdown hysteresis ( $T_{SHDN(HYS)}$ ), typically 40°C. The thermal shutdown is also cleared if  $V_{CC}$  drops below  $V_{CC(reset)}$ . A new power up sequences commences at the next  $V_{CC(on)}$  once all the faults are removed.

### Driver

The NCP1365 maximum supply voltage,  $V_{CC(max)}$ , is 28 V. Typical high-voltage MOSFETs have a maximum gate voltage rating of 20 V. The  $DRV$  pin incorporates an active voltage clamp which limits the gate voltage on the external mosfet. The  $DRV$  voltage clamp,  $V_{DRV(high)}$  is set to 13 V maximum.

**TABLE OF AVAILABLE OPTIONS**

Function	Options
Fault Mode	$V_{CC\_OVP}$ Latched / Full Autorecovery / $V_{out\_UVP}$ latched
CaBle drop Compensation	No/150/300/450 mV
Minimum operating frequency in VCO	200 Hz / 600 Hz / 1.2 kHz / 23 kHz
Frequency Clamp or Maximum operating frequency	No Clamp / 80 kHz / 110 kHz

### ORDERING TABLE OPTION

OPN # NCP136____Y	HV Startup		Fault Mode			Min Operating Fsw (STBY)					Frequency Clamp			Cable Compensation			
	5	0	A	B	C*	A	B	C	D**	E***	A	B	C	A	B	C	D
	Yes	No	$V_{CC\_OVP}$ Latched	Full Autorecovery	$V_{out\_UVP}$ Latched	200 Hz	600 Hz	1.2 kHz	23 kHz	No Fmin	No	80 kHz	110 kHz	No	150 mV	300 mV	450 mV
NCP1365AABCY	X		X			X						X				X	
NCP1365BABCY	X			X		X						X				X	
NCP1365CABCY	X				X	X						X				X	
NCP1360AABCY		X	X			X						X				X	
NCP1360BABCY		X		X		X						X				X	
NCP1360CABCY		X			X	X						X				X	

\* Available upon request

\*\* Min operating frequency D version is only available with fault Mode A & B.

\*\*\* Min operating frequency E version is only available with fault Mode C.

## NCP1360, NCP1365

### ORDERING INFORMATION

Device	Marking	Package	Shipping†
NCP1365AABCYDR2G	1365A1	SOIC-7 (Pb-Free)	2500 / Tape & Reel
NCP1365BABCYDR2G	1365B1	SOIC-7 (Pb-Free)	2500 / Tape & Reel
NCP1360AABCYSNT1G	ADA	TSOP-6 (Pb-Free)	3000 / Tape & Reel
NCP1360BABCYSNT1G	ADC	TSOP-6 (Pb-Free)	3000 / Tape & Reel

†For information on tape and reel specifications, including part orientation and tape sizes, please refer to our Tape and Reel Packaging Specifications Brochure, BRD8011/D.

# NCP1360, NCP1365

## PACKAGE DIMENSIONS

### SOIC-7 CASE 751U ISSUE E

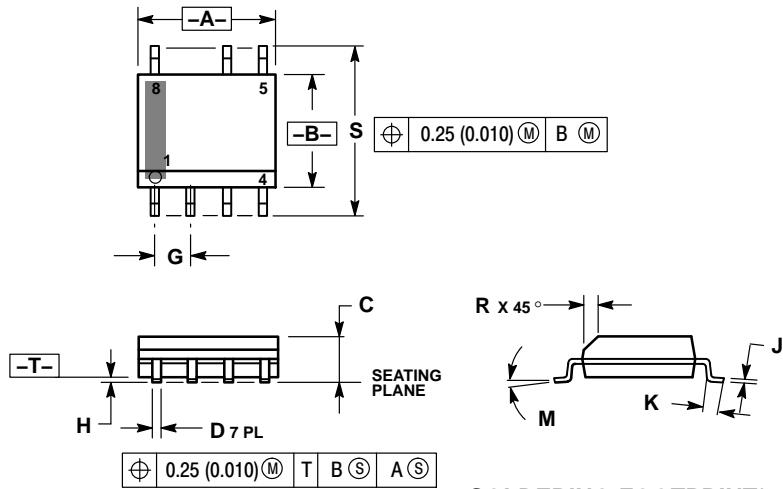

**NOTES:**

1. DIMENSIONING AND TOLERANCING PER ANSI Y14.5M, 1982.
2. CONTROLLING DIMENSION: MILLIMETER.
3. DIMENSION A AND B ARE DATUMS AND T IS A DATUM SURFACE.
4. DIMENSION A AND B DO NOT INCLUDE MOLD PROTRUSION.
5. MAXIMUM MOLD PROTRUSION 0.15 (0.006) PER SIDE.

DIM	MILLIMETERS		INCHES	
	MIN	MAX	MIN	MAX
A	4.80	5.00	0.189	0.197
B	3.80	4.00	0.150	0.157
C	1.35	1.75	0.053	0.069
D	0.33	0.51	0.013	0.020
G	1.27 BSC		0.050 BSC	
H	0.10	0.25	0.004	0.010
J	0.19	0.25	0.007	0.010
K	0.40	1.27	0.016	0.050
M	0° 8°		0° 8°	
N	0.25	0.50	0.010	0.020
S	5.80	6.20	0.228	0.244

### SOLDERING FOOTPRINT\*

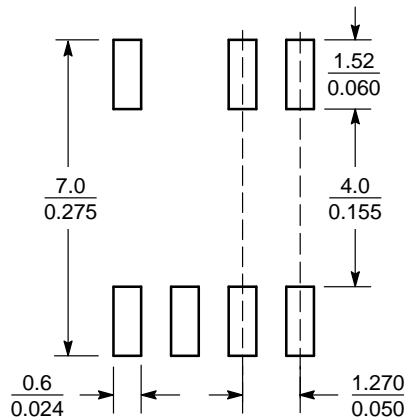

SCALE 6:1 ( $\frac{\text{mm}}{\text{inches}}$ )

\*For additional information on our Pb-Free strategy and soldering details, please download the ON Semiconductor Soldering and Mounting Techniques Reference Manual, SOLDERRM/D.

# NCP1360, NCP1365

## PACKAGE DIMENSIONS

### TSOP-6 CASE 318G-02 ISSUE V

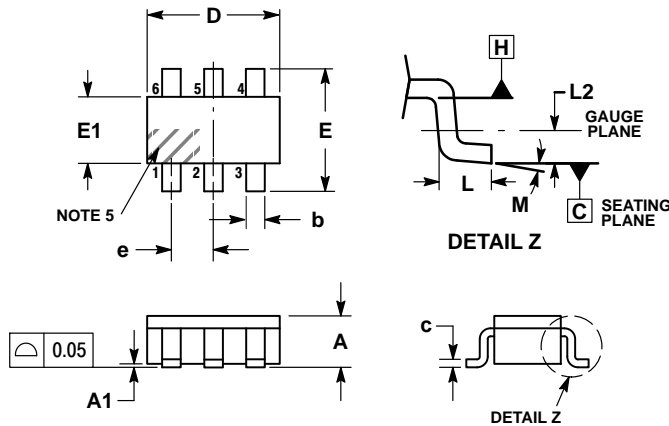

**NOTES:**

1. DIMENSIONING AND TOLERANCING PER ASME Y14.5M, 1994.
2. CONTROLLING DIMENSION: MILLIMETERS.
3. MAXIMUM LEAD THICKNESS INCLUDES LEAD FINISH. MINIMUM LEAD THICKNESS IS THE MINIMUM THICKNESS OF BASE MATERIAL.
4. DIMENSIONS D AND E1 DO NOT INCLUDE MOLD FLASH, PROTRUSIONS, OR GATE BURRS. MOLD FLASH, PROTRUSIONS, OR GATE BURRS SHALL NOT EXCEED 0.15 PER SIDE. DIMENSIONS D AND E1 ARE DETERMINED AT DATUM H.
5. PIN ONE INDICATOR MUST BE LOCATED IN THE INDICATED ZONE.

DIM	MILLIMETERS		
	MIN	NOM	MAX
A	0.90	1.00	1.10
A1	0.01	0.06	0.10
b	0.25	0.38	0.50
c	0.10	0.18	0.26
D	2.90	3.00	3.10
E	2.50	2.75	3.00
E1	1.30	1.50	1.70
e	0.85	0.95	1.05
L	0.20	0.40	0.60
L2	0.25 BSC		
M	-		

0° 10°

### RECOMMENDED SOLDERING FOOTPRINT\*

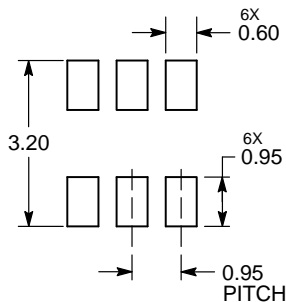

DIMENSIONS: MILLIMETERS

\*For additional information on our Pb-Free strategy and soldering details, please download the ON Semiconductor Soldering and Mounting Techniques Reference Manual, SOLDERRM/D.

ON Semiconductor and are trademarks of Semiconductor Components Industries, LLC dba ON Semiconductor or its subsidiaries in the United States and/or other countries. ON Semiconductor owns the rights to a number of patents, trademarks, copyrights, trade secrets, and other intellectual property. A listing of ON Semiconductor's product/patent coverage may be accessed at [www.onsemi.com/site/pdf/Patent-Marketing.pdf](http://www.onsemi.com/site/pdf/Patent-Marketing.pdf). ON Semiconductor reserves the right to make changes without further notice to any products herein. ON Semiconductor makes no warranty, representation or guarantee regarding the suitability of its products for any particular purpose, nor does ON Semiconductor assume any liability arising out of the application or use of any product or circuit, and specifically disclaims any and all liability, including without limitation special, consequential or incidental damages. Buyer is responsible for its products and applications using ON Semiconductor products, including compliance with all laws, regulations and safety requirements or standards, regardless of any support or applications information provided by ON Semiconductor. "Typical" parameters which may be provided in ON Semiconductor data sheets and/or specifications can and do vary in different applications and actual performance may vary over time. All operating parameters, including "Typicals" must be validated for each customer application by customer's technical experts. ON Semiconductor does not convey any license under its patent rights nor the rights of others. ON Semiconductor products are not designed, intended, or authorized for use as a critical component in life support systems or any FDA Class 3 medical devices or medical devices with a same or similar classification in a foreign jurisdiction or any devices intended for implantation in the human body. Should Buyer purchase or use ON Semiconductor products for any such unintended or unauthorized application, Buyer shall indemnify and hold ON Semiconductor and its officers, employees, subsidiaries, affiliates, and distributors harmless against all claims, costs, damages, and expenses, and reasonable attorney fees arising out of, directly or indirectly, any claim of personal injury or death associated with such unintended or unauthorized use, even if such claim alleges that ON Semiconductor was negligent regarding the design or manufacture of the part. ON Semiconductor is an Equal Opportunity/Affirmative Action Employer. This literature is subject to all applicable copyright laws and is not for resale in any manner.

### PUBLICATION ORDERING INFORMATION

**LITERATURE FULFILLMENT:**  
Literature Distribution Center for ON Semiconductor  
19521 E. 32nd Pkwy, Aurora, Colorado 80011 USA  
**Phone:** 303-675-2175 or 800-344-3860 Toll Free USA/Canada  
**Fax:** 303-675-2176 or 800-344-3867 Toll Free USA/Canada  
**Email:** [orderlit@onsemi.com](mailto:orderlit@onsemi.com)

**N. American Technical Support:** 800-282-9855 Toll Free  
USA/Canada  
**Europe, Middle East and Africa Technical Support:**  
Phone: 421 33 790 2910  
**Japan Customer Focus Center**  
Phone: 81-3-5817-1050

**ON Semiconductor Website:** [www.onsemi.com](http://www.onsemi.com)  
**Order Literature:** <http://www.onsemi.com/orderlit>

For additional information, please contact your local Sales Representative