

Digital color sensor

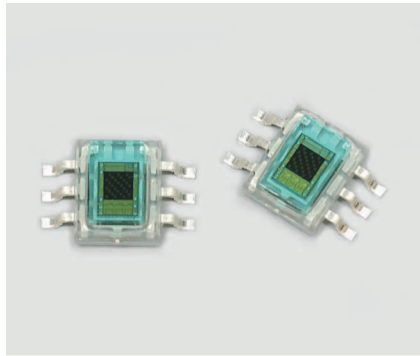

S9706

12-bit digital output

The S9706 is a digital color sensor sensitive to red ($\lambda=615$ nm), green ($\lambda=540$ nm) and blue ($\lambda=465$ nm) regions of the spectrum. Detected signals are serially output as 12-bit digital data. Built-in three 12-bit registers allow simultaneous measurement of RGB three colors. Sensitivity level is adjustable in two steps to cover a wide photometric range.

Features

- 12-bit digital output
- Simultaneous measurement of RGB three colors
- 2-step sensitivity switching (sensitivity ratio of 1 : 9)
- Low voltage (3.3 V) operation
- CMOS monolithic photo IC
- No external components required

Applications

- Display color adjustment
- Various applications involving color detection

Feature 01 12-bit digital output

Light signals detected by the photodiode are amplified and converted into 12-bit digital signals. An amplifier is also formed for each of the RGB photodiode elements arrayed in the mosaic pattern, allowing simultaneous accurate measurement of the RGB components of incident light.

Feature 02 Simultaneous measurement of RGB three colors

The photodiode consists of 9×9 elements arrayed in a mosaic pattern. Each element has an on-chip filter that it sensitive to one color of light, either red ($\lambda_p=615$ nm), green ($\lambda_p=540$ nm) or blue ($\lambda_p=465$ nm).

Block diagram

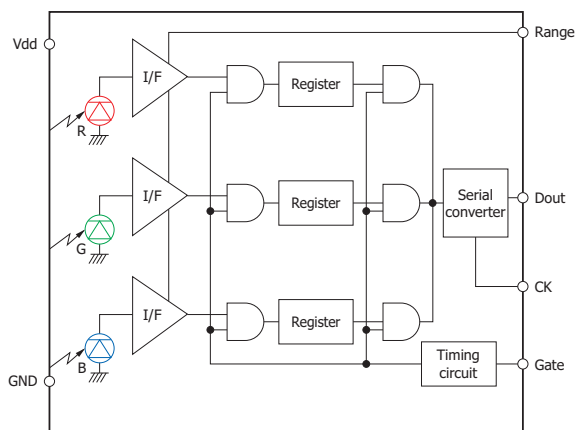

KPIC00110EB

Spectral response

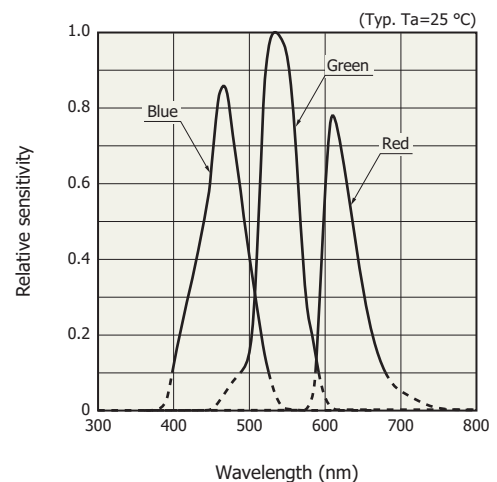

KPICB0089EA

This product does not support lead-free soldering. Solder it by hand.

Feature **03** 2-step sensitivity switching

To enable measurement over a wide range of illuminance, the photodiode sensitivity can be selected from two setting modes (high sensitivity mode and low sensitivity mode). The photodiode photosensitive area used to detect light differs depending on which sensitivity mode is selected (high sensitivity mode: 9 × 9 elements, low sensitivity mode: 3 × 3 elements in center).

☒ Sensitivity setting

Range	Mode	Effective photosensitive area*
High	High sensitivity	9 × 9 elements
Low	Low sensitivity	3 × 3 elements

* The photosensitive area of S9706 consists of 9 × 9 elements in a mosaic pattern.

The effective photosensitive area changes depending on which sensitivity mode is used, "high" or "low", as explained below.

- High sensitivity mode: 9 × 9 elements
- Low sensitivity mode: 3 × 3 elements in center

☒ Details of photosensitive area (unit: μm)

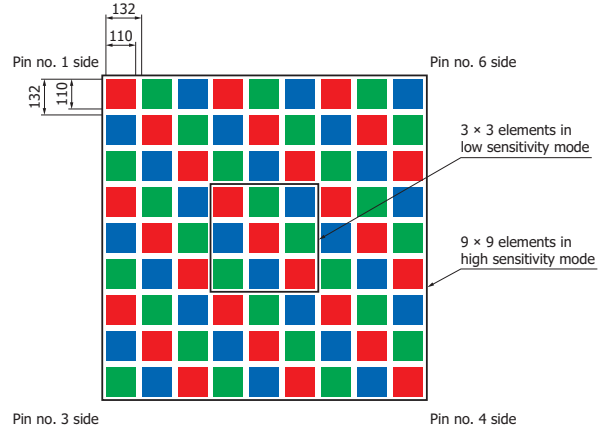

Note: Spacing between elements is light-shielded.

KPIC0124EB

☒ Absolute maximum ratings

Parameter	Symbol	Condition	Value	Unit
Supply voltage	Vdd	Ta=25 °C	-0.3 to 6	V
Load current	Io	Ta=25 °C	±10	mA
Power dissipation	P	Ta=25 °C	100	mW
Operating temperature	Topr		-20 to +85	°C
Storage temperature	Tstg		-20 to +85	°C

Note: Exceeding the absolute maximum ratings even momentarily may cause a drop in product quality. Always be sure to use the product within the absolute maximum ratings.

Electrical and optical characteristics (Ta=25 °C, Vdd=5 V, Tg=100 ms, A light source, unless otherwise noted)

Parameter	Symbol	Condition	Min.	Typ.	Max.	Unit
Photosensitive area size	-	All elements (9 × 9 elements)	-	1.2 × 1.2	-	mm
Effective photosensitive area	-	Per 1 color, High range	-	0.32	-	mm ²
Spectral response range	λ	Blue	-	400 to 540	-	nm
		Green	-	480 to 600	-	
		Red	-	590 to 720	-	
Peak sensitivity wavelength	λp	Blue	-	465	-	nm
		Green	-	540	-	
		Red	-	615	-	
Supply voltage	Vdd		3.0	-	5.5	V
Current consumption	Idd	Dark state, no load	-	5	10	mA
Photosensitivity	Sbl	Blue, Low range	0.15	0.21	0.27	LSB/lx
	Sgl	Green, Low range	0.32	0.45	0.59	
	Srl	Red, Low range	0.45	0.64	0.83	
	Sbh	Blue, High range	1.3	1.9	2.5	
	Sgh	Green, High range	2.8	4.1	5.4	
	Srh	Red, High range	4.0	5.8	7.6	
Incident light power (Conversion value in A light source)	Ibl	Blue, Low range	-	-	240	k/lx
	Igl	Green, Low range	-	-	110	
	Irl	Red, Low range	-	-	78	
	Ibh	Blue, High range	-	-	26	
	Igh	Green, High range	-	-	12	
	Irh	Red, High range	-	-	8.6	
Dark output	Dark	Tg=0.5 s	-	-	1	LSB
Input high level	Vih		Vdd × 0.82	-	-	V
Input low level	Vil		-	-	Vdd × 0.18	V
High level output voltage	Voh	Ioh=-0.5 mA	4.5	-	-	V
Low level output voltage	Vol	Iol=0.5 mA	-	-	0.5	V
Integration time	Tg		Refer to "Output vs. illuminance"			-
Hold time	t1		4	-	-	μs
	t2		3	-	-	μs
	t3		3	-	-	μs
	t4		2000	-	-	μs
	t5		3	-	-	μs
Readout clock period	tck		500	-	-	ns
Readout pulse width (positive)	tw		200	-	-	ns
Readout pulse width (negative)	tck-tw		200	-	-	ns

Output vs. illuminance

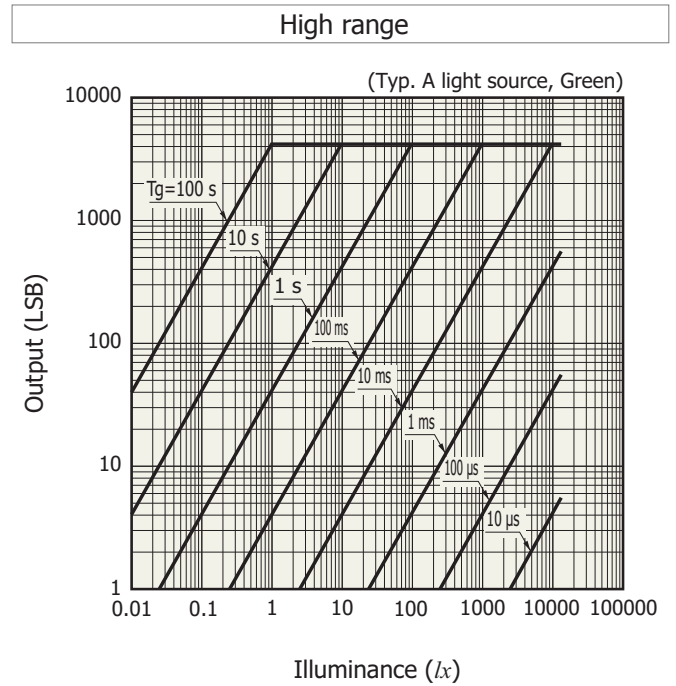
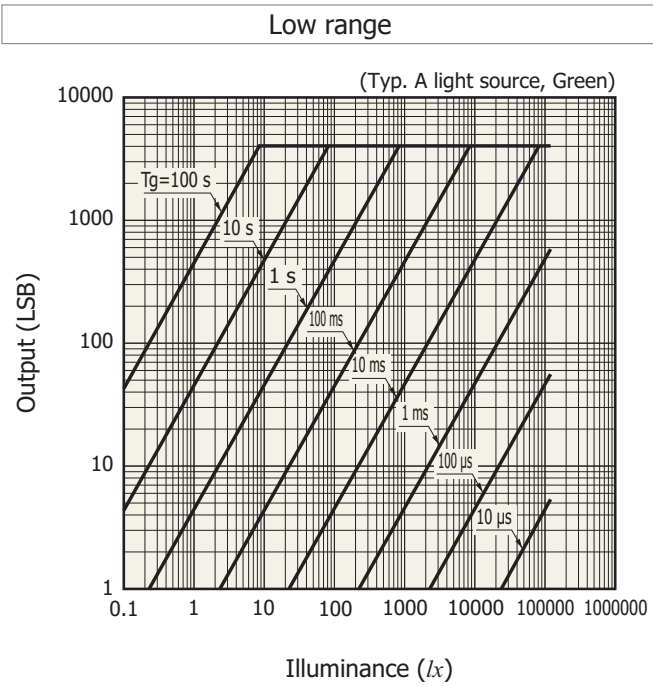

KPIC0099EA

KPIC0100EA

Timing chart

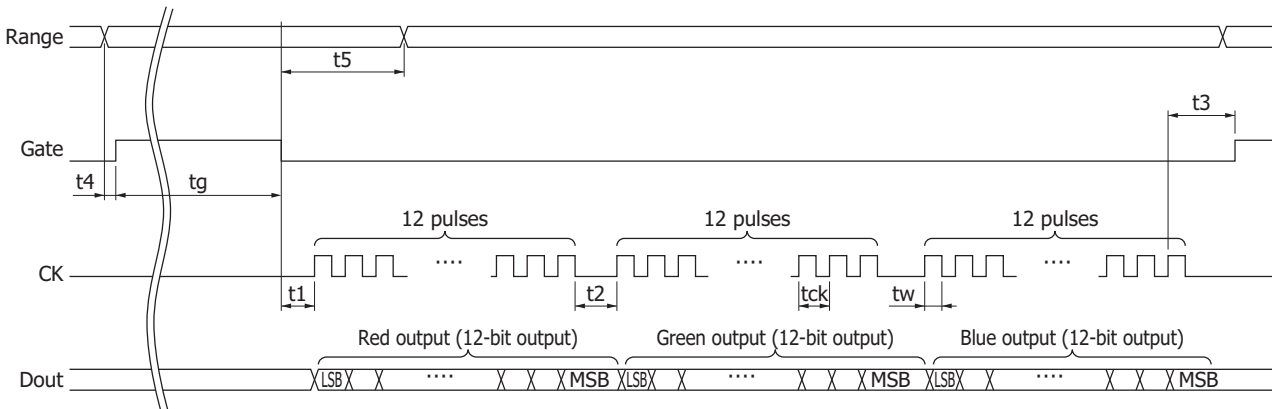

Operating sequence

- (1) Set the Gate terminal and CK terminal to "Low".
- (2) Select the desired sensitivity with the Range terminal.
- (3) Set the Gate terminal from "Low" to "High", to start integrating the light intensity.
- (4) After the desired integration time (t_g) has passed, set the Gate terminal from "High" to "Low" to end the light intensity integration.
- (5) Measurement data is output from the Dout terminal by inputting 36 CK pulses to the CK terminal.

Note 1: A total of 36 CK pulses are required to read out 3-color measurement data. Red data is output by the first 12 pulses, green data by the next 12 pulses, and blue data by the last 12 pulses. Measurement data is output from the LSB side.

Note 2: Measurement data changes at the CK pulse rising edge.

Note 3: Do not switch the Range terminal during integration time (t_g).

KPIC0115EB



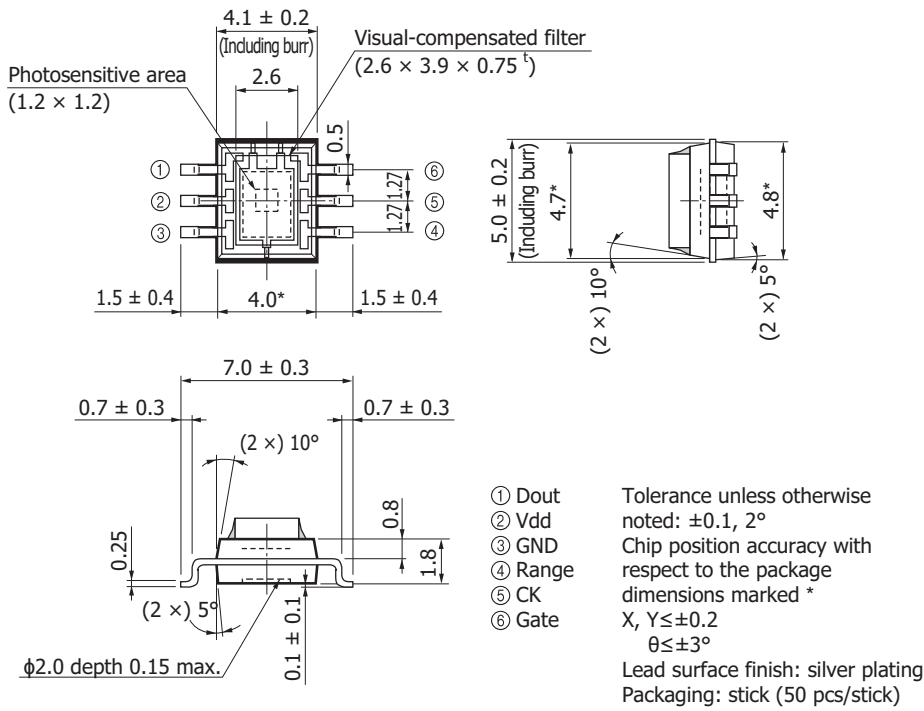











Dimensional outline (unit: mm)

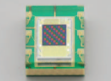

KPICA0060EE

Note: If excessive vibration is continuously applied to the glass filter, there is a risk that the filter may come off, so secure the glass filter with a holder.

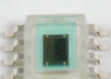
Line-up of RGB color sensors

Type no.	Type	Photosensitive area (mm)	Package (mm)	Peak sensitivity wavelength (nm)	Photosensitivity				Photo		
S9032-02	Photodiode	 $\phi 2.0$	4 × 4.8 × 1.8 ^t 6 pin (filter 0.75 ^t)	B 460	B	0.18 (A/W) [$\lambda=460$ nm]					
				G 540	G	0.23 (A/W) [$\lambda=540$ nm]					
				R 620	R	0.16 (A/W) [$\lambda=620$ nm]					
S9702	Photodiode	 1.0 × 1.0	3 × 4 × 1.3 ^t 4 pin (filter 0.75 ^t)	B 460	B	0.18 (A/W) [$\lambda=460$ nm]					
				G 540	G	0.23 (A/W) [$\lambda=540$ nm]					
				R 620	R	0.16 (A/W) [$\lambda=620$ nm]					
S10917-35GT	Photodiode	 1.0 × 1.0	3 × 1.6 × 1.0 ^t COB (on-chip filter)	B 460	B	0.2 (A/W) [$\lambda=460$ nm]					
				G 540	G	0.23 (A/W) [$\lambda=540$ nm]					
				R 620	R	0.17 (A/W) [$\lambda=620$ nm]					
S10942-01CT	Photodiode	 1.0 × 1.0	3 × 1.6 × 1.0 ^t COB (on-chip filter)	*	B	0.21 (A/W) [$\lambda=460$ nm]					
					G	0.25 (A/W) [$\lambda=540$ nm]					
					R	0.45 (A/W) [$\lambda=640$ nm]					
S9706	Digital photo IC	 1.2 × 1.2	4 × 4.8 × 1.8 ^t 6 pin (filter 0.75 ^t)	B 465	Low	B	0.21 (LSB/lx)	High	B	1.9 (LSB/lx)	
				G 540		G	0.45 (LSB/lx)		G	4.1 (LSB/lx)	
				R 615		R	0.64 (LSB/lx)		R	5.8 (LSB/lx)	
S11012-01CR	Digital photo IC	 1.2 × 1.2	3.43 × 3.8 × 1.6 ^t COB (on-chip filter)	*	Low	B	0.3 (LSB/lx)	High	B	2.6 (LSB/lx)	
						G	0.6 (LSB/lx)		G	5.3 (LSB/lx)	
						R	1.4 (LSB/lx)		R	12.9 (LSB/lx)	
S11059-02DT /-03DS	I ² C compatible color sensor	 0.56 × 1.22	3 × 4.2 × 1.3 ^t 10 pin (on-chip filter)	B 460	Low	B	4.4 (count/lx)	High	B	44.8 (count/lx)	
				G 530		G	8.3 (count/lx)		G	85.0 (count/lx)	
				R 615		R	11.2 (count/lx)		R	117.0 (count/lx)	
				IR 855		IR	3.0 (count/lx)		IR	30.0 (count/lx)	
S11059-01WT	I ² C compatible color sensor	 1.22 × 0.56	1.68 × 1.18 × 0.58 ^t WL-CSP (on-chip filter)	B 460	Low	B	3.35 (count/lx)	High	B	31.7 (count/lx)	
				G 530		G	7.61 (count/lx)		G	76.2 (count/lx)	
				R 615		R	9.48 (count/lx)		R	94.5 (count/lx)	
				IR 855		IR	1.66 (count/lx)		IR	15.3 (count/lx)	

* Refer to the spectral response of each product's datasheet.

Related information

www.hamamatsu.com/sp/ssd/doc_en.html

Precautions

- Disclaimer
- Metal, ceramic, plastic package products
- Surface mount type products

Information described in this material is current as of August, 2015.

Product specifications are subject to change without prior notice due to improvements or other reasons. This document has been carefully prepared and the information contained is believed to be accurate. In rare cases, however, there may be inaccuracies such as text errors. Before using these products, always contact us for the delivery specification sheet to check the latest specifications.

The product warranty is valid for one year after delivery and is limited to product repair or replacement for defects discovered and reported to us within that one year period. However, even if within the warranty period we accept absolutely no liability for any loss caused by natural disasters or improper product use. Copying or reprinting the contents described in this material in whole or in part is prohibited without our prior permission.

HAMAMATSU

www.hamamatsu.com

HAMAMATSU PHOTONICS K.K., Solid State Division

1126-1 Ichino-cho, Higashi-ku, Hamamatsu City, 435-8558 Japan, Telephone: (81) 53-434-3311, Fax: (81) 53-434-5184

U.S.A.: Hamamatsu Corporation: 360 Foothill Road, Bridgewater, N.J. 08807, U.S.A., Telephone: (1) 908-231-0960, Fax: (1) 908-231-1218

Germany: Hamamatsu Photonics Deutschland GmbH: Arzbergerstr. 10, D-82211 Herrsching am Ammersee, Germany, Telephone: (49) 8152-375-0, Fax: (49) 8152-265-8

France: Hamamatsu Photonics France S.A.R.L.: 19, Rue du Saule Trapu, Parc du Moulin de Massy, 91882 Massy Cedex, France, Telephone: 33-(1) 69 53 71 00, Fax: 33-(1) 69 53 71 10

United Kingdom: Hamamatsu Photonics UK Limited: 2 Howard Court, 10 Tewin Road, Welwyn Garden City, Hertfordshire AL7 1BW, United Kingdom, Telephone: (44) 1707-294888, Fax: (44) 1707-325777

North Europe: Hamamatsu Photonics Norden AB: Torshamnsgatan 35 16440 Kista, Sweden, Telephone: (46) 8-509-031-00, Fax: (46) 8-509-031-01

Italy: Hamamatsu Photonics Italia S.r.l.: Strada della Moia, 1 int. 6, 20020 Arese (Milano), Italy, Telephone: (39) 02-93581733, Fax: (39) 02-93581741

China: Hamamatsu Photonics (China) Co., Ltd.: B1201, Jiaiming Center, No.27 Dongsanhuan Beilu, Chaoyang District, Beijing 100020, China, Telephone: (86) 10-6586-6006, Fax: (86) 10-6586-2866