

N-channel 60 V, 0.0021 Ω typ., 120 A, STripFET™ F7 Power MOSFET in a TO-220 package

Datasheet - production data

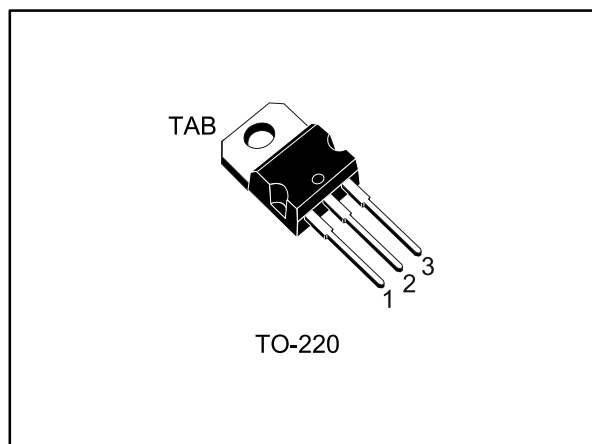

Features

Order code	V _{DS}	R _{DS(on)max}	I _D	P _{TOT}
STP220N6F7	60 V	0.0024 Ω	120 A	237 W

- Among the lowest R_{DS(on)} on the market
- Excellent figure of merit (FoM)
- Low C_{rss}/C_{iss} ratio for EMI immunity
- High avalanche ruggedness

Applications

- Switching applications

Description

This N-channel Power MOSFET utilizes STripFET™ F7 technology with an enhanced trench gate structure that results in very low on-state resistance, while also reducing internal capacitance and gate charge for faster and more efficient switching.

Figure 1: Internal schematic diagram

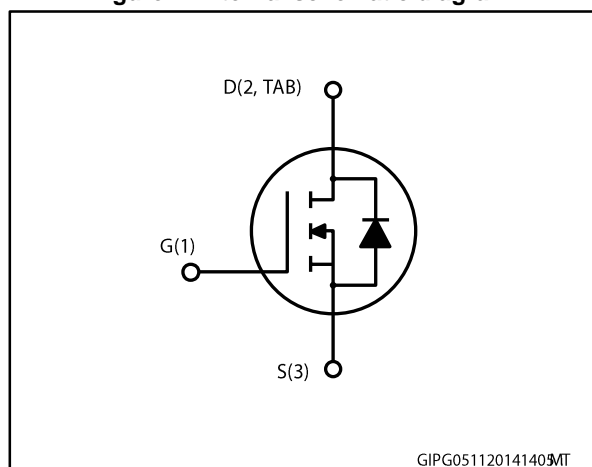

Table 1: Device summary

Order code	Marking	Package	Packaging
STP220N6F7	220N6F7	TO-220	Tube

Contents

1	Electrical ratings	3
2	Electrical characteristics	4
	2.1 Electrical characteristics (curves).....	6
3	Test circuits	8
4	Package mechanical data	9
	4.1 TO-220 package mechanical data	10
5	Revision history	12

1 Electrical ratings

Table 2: Absolute maximum ratings

Symbol	Parameter	Value	Unit
V_{DS}	Drain-source voltage	60	V
V_{GS}	Gate-source voltage	± 20	V
$I_D^{(1)}$	Drain current (continuous)	120	A
$I_D^{(1)}$	Drain current (continuous) at $T_C = 100\text{ }^\circ\text{C}$	120	A
$I_{DM}^{(2)}$	Drain current (pulsed) $T_C = 25\text{ }^\circ\text{C}$	480	A
P_{TOT}	Total dissipation at $T_C = 25\text{ }^\circ\text{C}$	237	W
$E_{AS}^{(3)}$	Single pulse avalanche energy	1	J
T_J	Operating junction temperature	-55 to 175	$^\circ\text{C}$
T_{stg}	Storage temperature		$^\circ\text{C}$

Notes:

(1)Current limited by package

(2)Pulse width is limited by safe operating area

(3)Starting $T_J = 25\text{ }^\circ\text{C}$, $I_d = 20\text{ A}$, $V_{dd} = 50\text{ V}$

Table 3: Thermal data

Symbol	Parameter	Value	Unit
$R_{thj-case}$	Thermal resistance junction-case max	0.63	$^\circ\text{C/W}$
$R_{thj-amb}$	Thermal resistance junction-ambient max	62.5	$^\circ\text{C/W}$

2 Electrical characteristics

($T_C = 25\text{ °C}$ unless otherwise specified)

Table 4: On /off states

Symbol	Parameter	Test conditions	Min.	Typ.	Max.	Unit
$V_{(BR)DSS}$	Drain-source breakdown voltage	$V_{GS} = 0, I_D = 1\text{ mA}$	60			V
I_{DSS}	Zero gate voltage drain current	$V_{GS} = 0, V_{DS} = 60\text{ V}$			1	μA
		$V_{GS} = 0, V_{DS} = 60\text{ V}, T_C = 125\text{ °C}$			100	μA
I_{GSS}	Gate-body leakage current	$V_{DS} = 0, V_{GS} = +20\text{ V}$			100	nA
$V_{GS(th)}$	Gate threshold voltage	$V_{DS} = V_{GS}, I_D = 250\text{ }\mu\text{A}$	2		4	V
$R_{DS(on)}$	Static drain-source on- resistance	$V_{GS} = 10\text{ V}, I_D = 60\text{ A}$		0.002 1	0.002 4	Ω

Table 5: Dynamic

Symbol	Parameter	Test conditions	Min.	Typ.	Max.	Unit
C_{iss}	Input capacitance	$V_{GS} = 0, V_{DS} = 25\text{ V}, f = 1\text{ MHz}$	-	6400	-	pF
C_{oss}	Output capacitance		-	3880	-	pF
C_{rss}	Reverse transfer capacitance		-	175	-	pF
Q_g	Total gate charge	$V_{DD} = 30\text{ V}, I_D = 120\text{ A}, V_{GS} = 10\text{ V}$ (see Figure 14: "Test circuit for gate charge behavior")	-	100	-	nC
Q_{gs}	Gate-source charge		-	36	-	nC
Q_{gd}	Gate-drain charge		-	24	-	nC

Table 6: Switching times

Symbol	Parameter	Test conditions	Min.	Typ.	Max.	Unit
$t_{d(on)}$	Turn-on delay time	$V_{DD} = 30\text{ V}, I_D = 60\text{ A}, R_G = 4.7\text{ }\Omega, V_{GS} = 10\text{ V}$ (see Figure 13: "Test circuit for resistive load switching times")	-	33	-	ns
t_r	Rise time		-	103	-	ns
$t_{d(off)}$	Turn-off delay time		-	54	-	ns
t_f	Fall time		-	29	-	ns

Table 7: Source drain diode

Symbol	Parameter	Test conditions	Min	Typ	Max	Unit
$V_{SD}^{(1)}$	Forward on voltage	$V_{GS} = 0, I_{SD} = 120 \text{ A}$	-	-	1.1	V
t_{rr}	Reverse recovery time	$I_{SD} = 120 \text{ A},$ $di/dt = 100 \text{ A}/\mu\text{s}$ $V_{DD} = 48 \text{ V}, T_J = 150 \text{ }^\circ\text{C}$ (see Figure 15: "Test circuit for inductive load switching and diode recovery times")	-	69		ns
Q_{rr}	Reverse recovery charge		-	104		nC
I_{RRM}	Reverse recovery current		-	3		A

Notes:

⁽¹⁾Pulsed: pulse duration = 300 μs , duty cycle 1.5%

2.1 Electrical characteristics (curves)

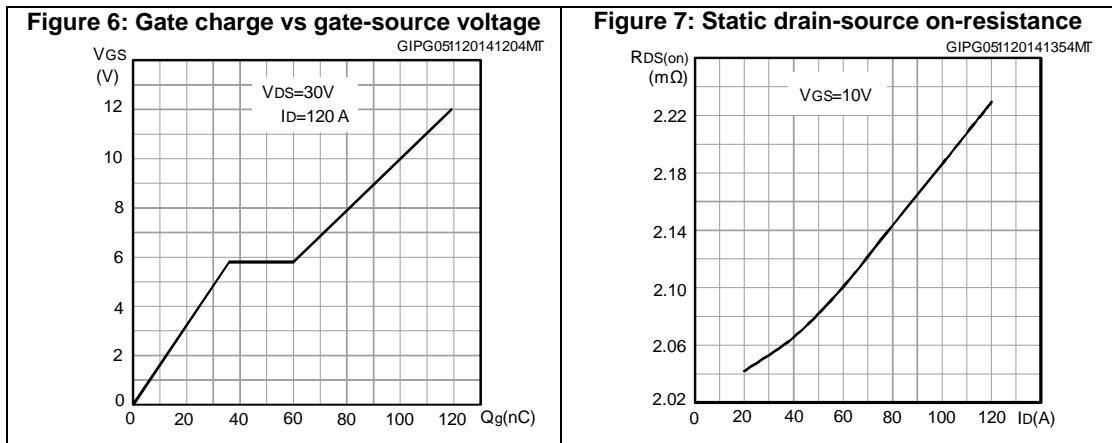
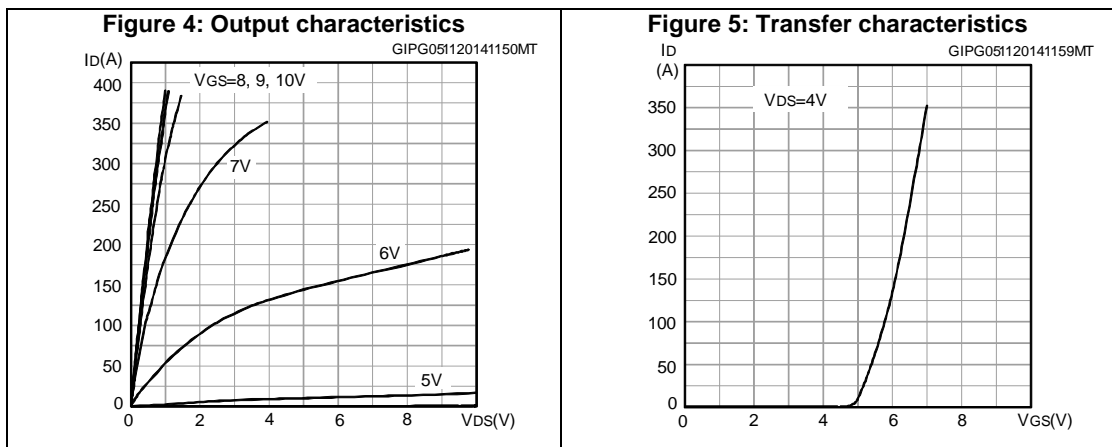
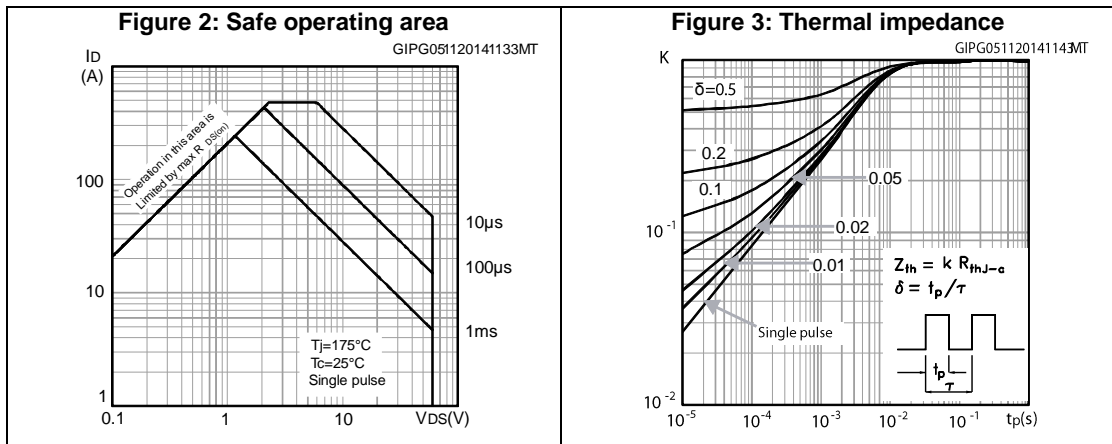

Figure 8: Capacitance variations

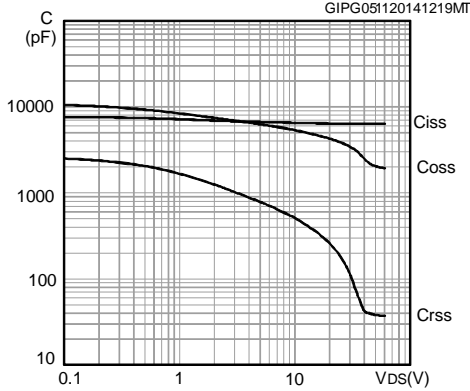

Figure 9: Normalized gate threshold voltage vs temperature

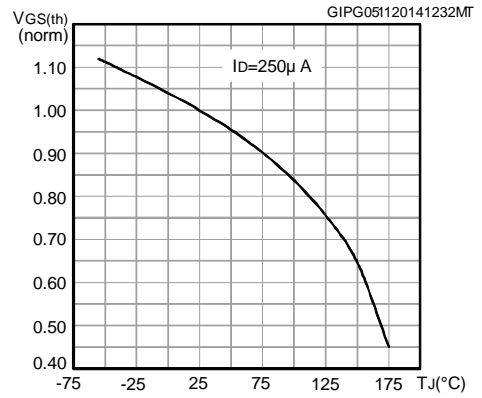

Figure 10: Normalized on-resistance vs temperature

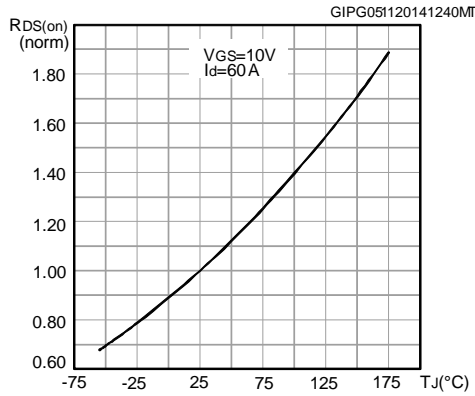

Figure 11: Normalized V(BR)DSS vs temperature

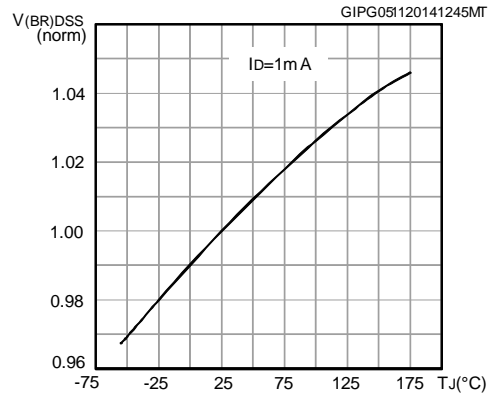
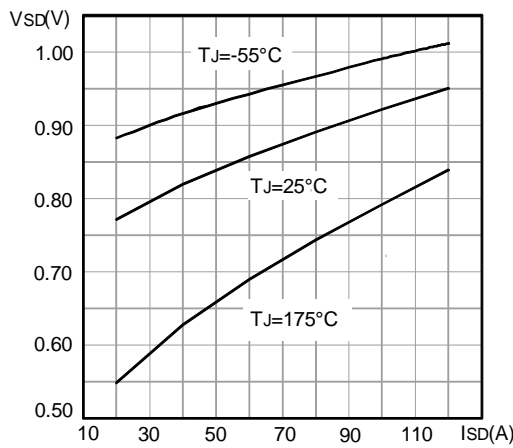

Figure 12: Source-drain diode forward characteristics



3 Test circuits

Figure 13: Test circuit for resistive load switching times



AM01468v1

Figure 14: Test circuit for gate charge behavior



AM01469v1

Figure 15: Test circuit for inductive load switching and diode recovery times

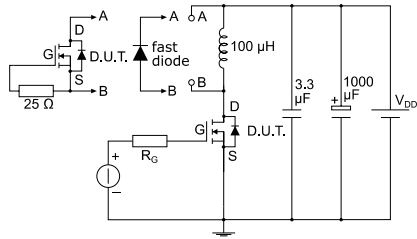

AM01470v1

Figure 16: Unclamped inductive load test circuit

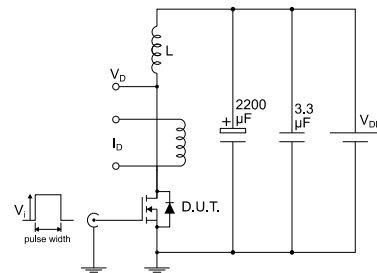

AM01471v1

Figure 17: Unclamped inductive waveform

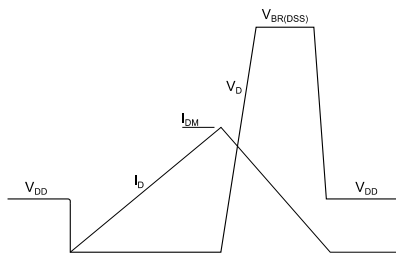

AM01472v1

Figure 18: Switching time waveform

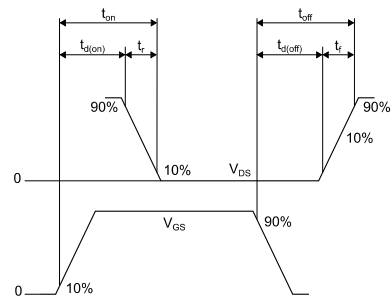

AM01473v1

4 Package mechanical data

In order to meet environmental requirements, ST offers these devices in different grades of ECOPACK® packages, depending on their level of environmental compliance. ECOPACK® specifications, grade definitions and product status are available at: www.st.com. ECOPACK® is an ST trademark.

4.1 TO-220 package mechanical data

Figure 19: TO-220 type A package outline

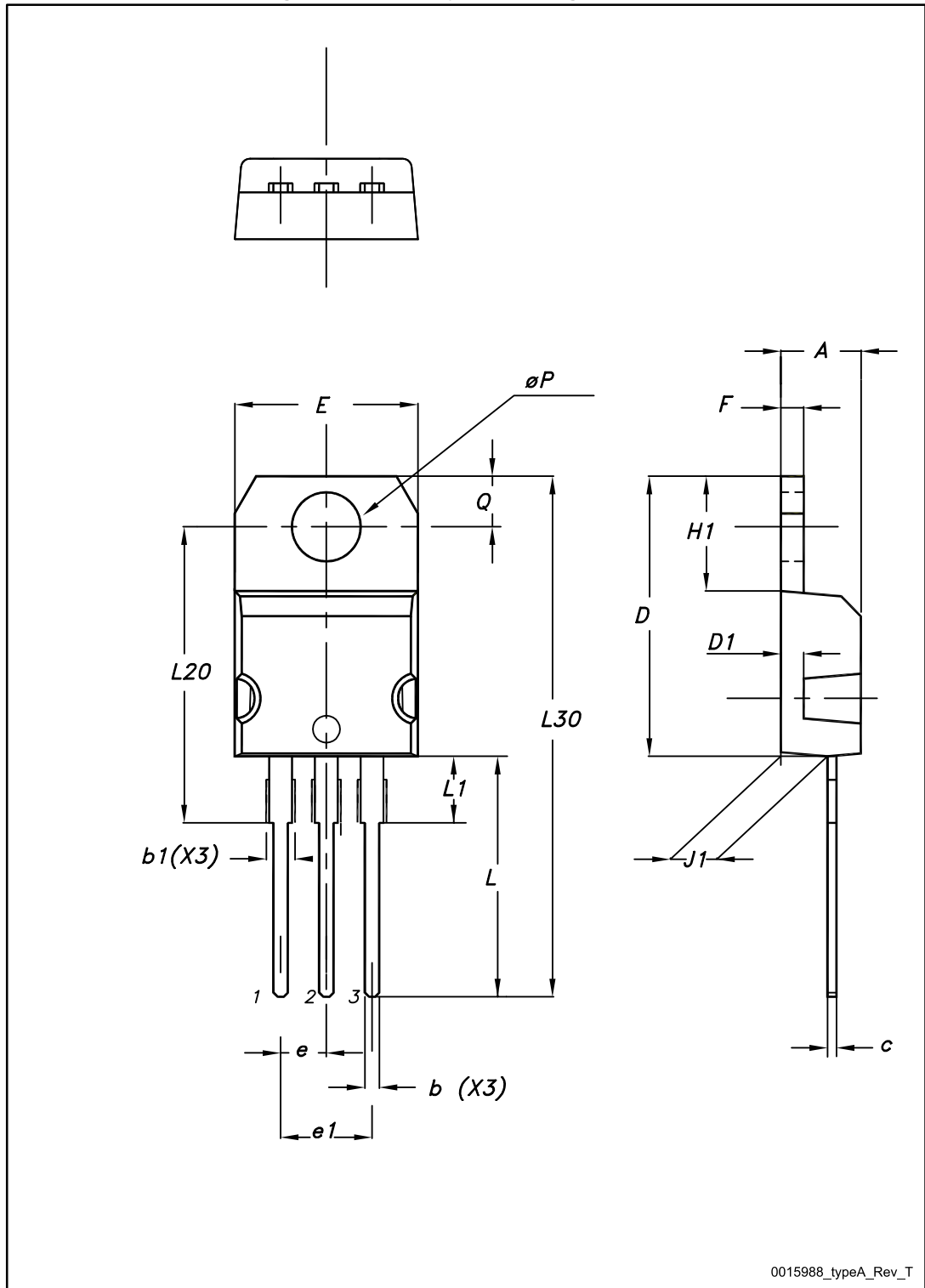

0015988_typeA_Rev_T

Table 8: TO-220 type A mechanical data

Dim.	mm		
	Min.	Typ.	Max.
A	4.40		4.60
b	0.61		0.88
b1	1.14		1.70
c	0.48		0.70
D	15.25		15.75
D1		1.27	
E	10		10.40
e	2.40		2.70
e1	4.95		5.15
F	1.23		1.32
H1	6.20		6.60
J1	2.40		2.72
L	13		14
L1	3.50		3.93
L20		16.40	
L30		28.90	
øP	3.75		3.85
Q	2.65		2.95

5 Revision history

Table 9: Document revision history

Date	Revision	Changes
17-Jun-2014	1	Initial release.
05-Nov-2014	2	Updated title and features in cover page. Updated Electrical rating and Electrical characteristics. Added Electrical characteristics (curves) . Minor text changes.
07-Oct-2015	3	Document status promoted from preliminary to production data.

IMPORTANT NOTICE – PLEASE READ CAREFULLY

STMicroelectronics NV and its subsidiaries ("ST") reserve the right to make changes, corrections, enhancements, modifications, and improvements to ST products and/or to this document at any time without notice. Purchasers should obtain the latest relevant information on ST products before placing orders. ST products are sold pursuant to ST's terms and conditions of sale in place at the time of order acknowledgement.

Purchasers are solely responsible for the choice, selection, and use of ST products and ST assumes no liability for application assistance or the design of Purchasers' products.

No license, express or implied, to any intellectual property right is granted by ST herein.

Resale of ST products with provisions different from the information set forth herein shall void any warranty granted by ST for such product.

ST and the ST logo are trademarks of ST. All other product or service names are the property of their respective owners.

Information in this document supersedes and replaces information previously supplied in any prior versions of this document.

© 2015 STMicroelectronics – All rights reserved