



## 1 Amp Schottky Barrier Rectifiers

Qualified per MIL-PRF-19500/586

Qualified Levels\*:  
JAN, JANTX, JANTXV  
and JANS

### DESCRIPTION

This 1 Amp schottky barrier rectifier is metallurgically bonded and offers military grade qualifications for the part numbers of 1N5819UR-1 and 1N6761UR-1 for high-reliability applications. This small diode is hermetically sealed and bonded into a DO-213AB MELF glass package.



**DO-213AB (MELF, LL41) Package**

**Important:** For the latest information, visit our website <http://www.microsemi.com>.

### FEATURES

- JEDEC registered 1N5818, 1N5819 and 1N6761 numbers.
- Hermetically sealed DO-41 glass package.
- Metallurgically bonded.
- \*1N5819UR-1 and 1N6761UR-1 only are available in JAN, JANTX, JANTXV and JANS qualifications per MIL-PRF-19500/586.  
(See [part nomenclature](#) for all available options.)
- RoHS compliant versions available (commercial grade only).

Also available in:

**DO-41 package**

(axial-leaded)

 [1N5818-1, 1N5819-1, 1N6759-1 – 1N6761-1 and DSB variants](#)

### APPLICATIONS / BENEFITS

- Small size for high density mounting using flexible thru-hole leads (see package illustration).
- Low reverse (leakage) currents.
- Non-sensitive to ESD per MIL-STD-750 test method 1020 (human body model).
- Inherently radiation hard as described in Microsemi "[MicroNote 050](#)".

### MAXIMUM RATINGS @ T<sub>A</sub> = +25 °C unless otherwise specified

Parameters/Test Conditions	Symbol	Value	Unit
Storage Temperature	T <sub>STG</sub>	-65 to +150	°C
Junction Temperature	T <sub>J</sub>	-65 to +125 -65 to +150	°C
Thermal Resistance, Junction-to-Lead	R <sub>θJEC</sub>	40	°C/W
Thermal Resistance, Junction-to-Ambient	R <sub>θJA</sub>	220	°C/W
Average Rectified Output Current @ T <sub>A</sub> = 55 °C on PCB board	I <sub>O</sub>	1.0	A
Surge Peak Forward Current	I <sub>FSM</sub>	25	A
Solder Temperature @ 10 s		260	°C

**NOTE:** 1. T<sub>EC</sub> = 55 °C for the 1N5819UR-1 and T<sub>EC</sub> = 37 °C for the 1N6761UR-1.

#### **MSC – Lawrence**

6 Lake Street,  
Lawrence, MA 01841  
Tel: 1-800-446-1158 or  
(978) 620-2600  
Fax: (978) 689-0803

#### **MSC – Ireland**

Gort Road Business Park,  
Ennis, Co. Clare, Ireland  
Tel: +353 (0) 65 6840044  
Fax: +353 (0) 65 6822298

**Website:**

[www.microsemi.com](http://www.microsemi.com)

**MECHANICAL and PACKAGING**

- CASE: Hermetically sealed glass DO-213AB MELF (LL41) package.
- TERMINALS: Tin/lead or RoHS compliant matte-tin finished copper clad steel available (commercial grade only). Solderable per MIL-STD-750, method 2026.
- MARKING: Cathode band.
- POLARITY: Diode to be operated with the banded end positive with respect to the opposite end for Zener regulation.
- MOUNTING SURFACE SELECTION: The Axial Coefficient of Expansion (COE) of this device is approximately +6PPM/°C. The COE of the Mounting Surface System should be selected to provide a suitable match with this device.
- TAPE & REEL optional: Standard per EIA-481-1-A with 12 mm tape. Consult factory for quantities.
- WEIGHT: Approximately 0.05 grams.
- See [Package Dimensions](#) on last page.

**PART NOMENCLATURE**

1N5818UR-1, 1N5819UR-1\* and 1N6761UR-1\*:

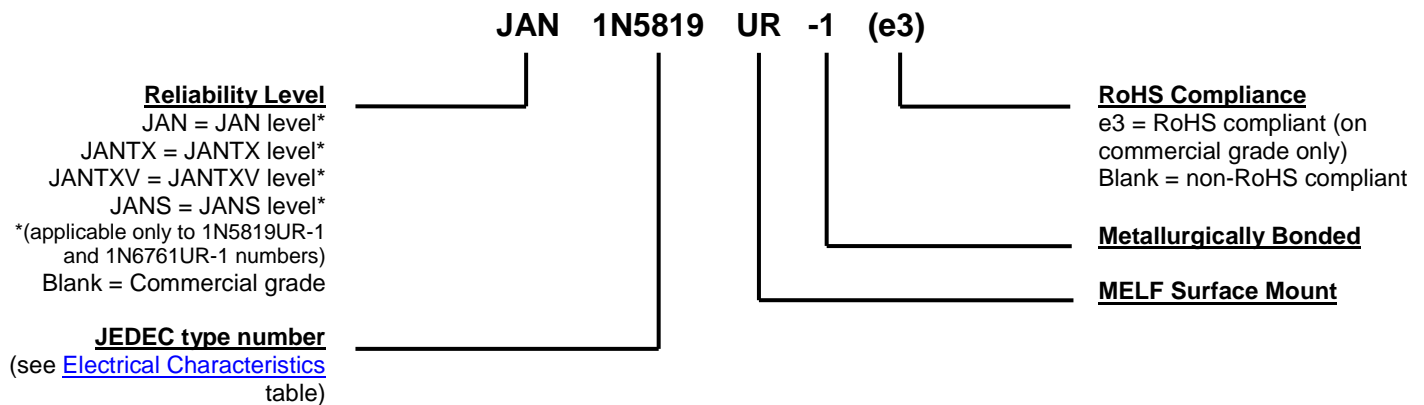

CDLL6759 – CDLL6761:

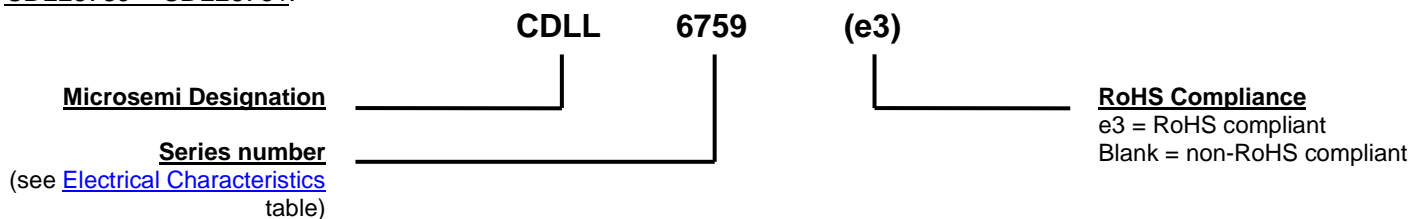

CDLL1A20 – CDLL1A100:

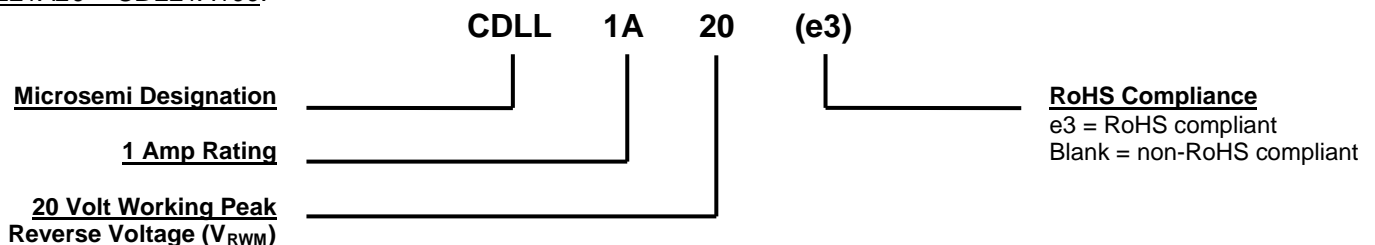

**SYMBOLS & DEFINITIONS**

Symbol	Definition
$C_T$	Total Capacitance: The total small signal capacitance between the diode terminals of a complete device.
$f$	frequency
$I_{FSM}$	Surge Peak Forward Current: The forward current including all nonrepetitive transient currents but excluding all repetitive transients (ref JESD282-B)
$I_R$	Reverse Current: The dc current flowing from the external circuit into the cathode terminal at the specified voltage $V_R$ .
$I_O$	Average Rectified Output Current: The output current averaged over a full cycle with a 50 Hz or 60 Hz sine-wave input and a 180 degree conduction angle.
$V_{(BR)}$	Minimum Breakdown Voltage: The minimum voltage the device will exhibit at a specified current.
$V_F$	Forward Voltage: The positive anode-cathode voltage the device will exhibit at a specified $I_F$ current.
$V_R$	Reverse Voltage: The dc voltage applied in the reverse direction below the breakdown region.
$V_{RWM}$	Working Peak Reverse Voltage: The maximum peak voltage that can be applied over the operating temperature range excluding all transient voltages (ref JESD282-B). Also sometimes known as PIV.

**\*ELECTRICAL CHARACTERISTICS @  $T_A = 25^\circ\text{C}$  unless otherwise specified**

TYPE NUMBER	WORKING PEAK REVERSE VOLTAGE <sup>(1)</sup>	MAXIMUM FORWARD VOLTAGE		MAXIMUM REVERSE LEAKAGE CURRENT AT RATED VOLTAGE		MAXIMUM CAPACITANCE @ $V_R = 5$ VOLTS $f \leq 1.0$ MHz
		$V_F @ 0.1\text{A}$	$V_F @ 1.0\text{A}$	$I_{RM} @ 25^\circ\text{C}$	$I_{RM} @ 100^\circ\text{C}$	
	$V_{RWM}$ Volts	Volts	Volts	mA	mA	$C_T$ pF
1N5818UR-1*	30	0.36	0.60	0.10	5.0	0.9
†1N5819UR-1*	45	0.34	0.49	0.05	5.0	70
CDLL6759	60	0.38	0.69	0.10	6.0	NA
CDLL6760	80	0.38	0.69	0.10	6.0	NA
†1N6761UR-1*	100	0.38	0.69	0.10	12.0	70
CDLL1A20	20	0.36	0.60	0.10	5.0	0.9
CDLL1A30	30	0.36	0.60	0.10	5.0	0.9
CDLL1A40	40	0.36	0.60	0.10	5.0	0.9
CDLL1A50	50	0.36	0.60	0.10	5.0	0.9
CDLL1A60	60	0.38	0.69	0.10	12.0	NA
CDLL1A80	80	0.38	0.69	0.10	12.0	NA
CDLL1A100	100	0.38	0.69	0.10	12.0	NA

\*Part number may also be ordered as CDLL5818 or CDLL5819 or CDLL6761.

† Also available with JAN, JANTX, JANTXV, and JANS military qualifications.

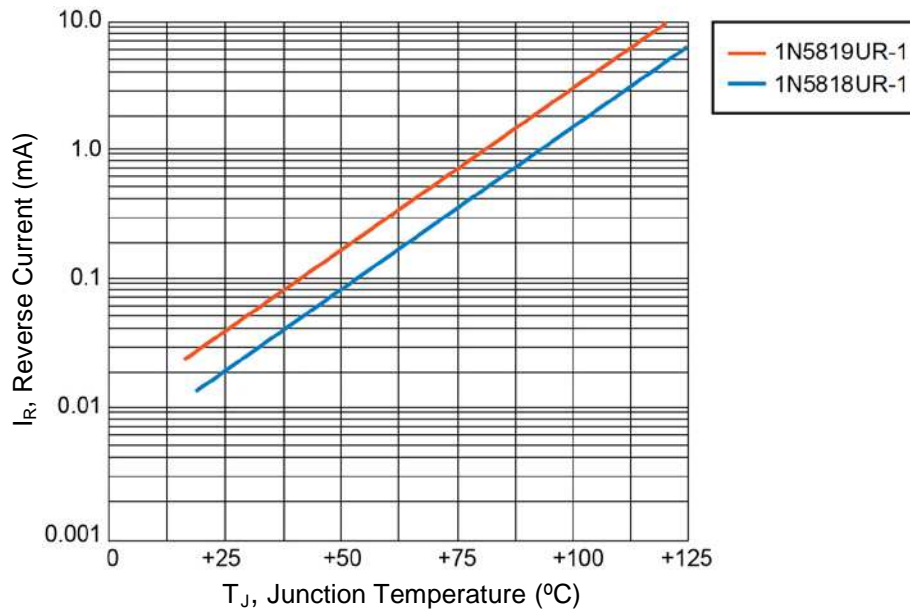
**GRAPHS**

**FIGURE 1**  
Typical Reverse Leakage Current at Rated PIV (PULSED)

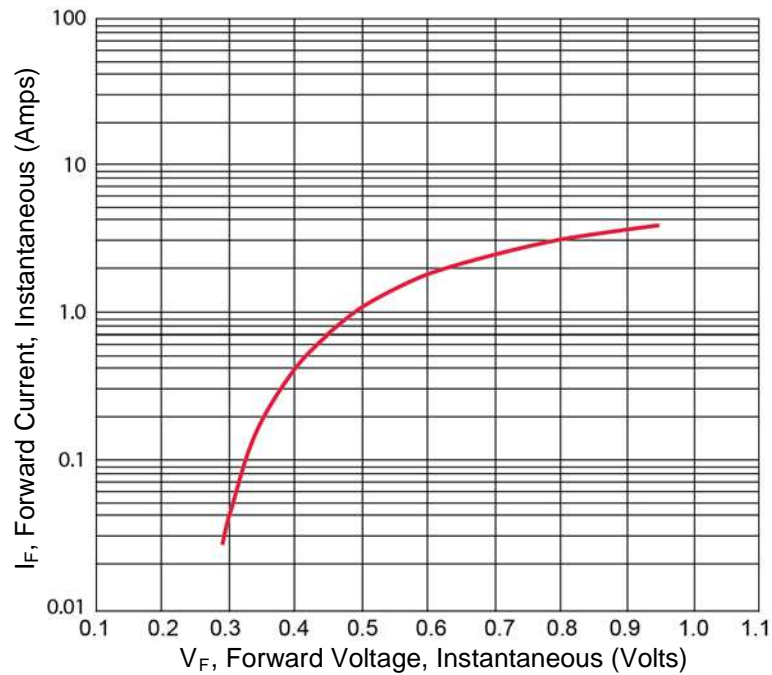

**FIGURE 2**  
Typical Forward Voltage for 1N5819UR-1

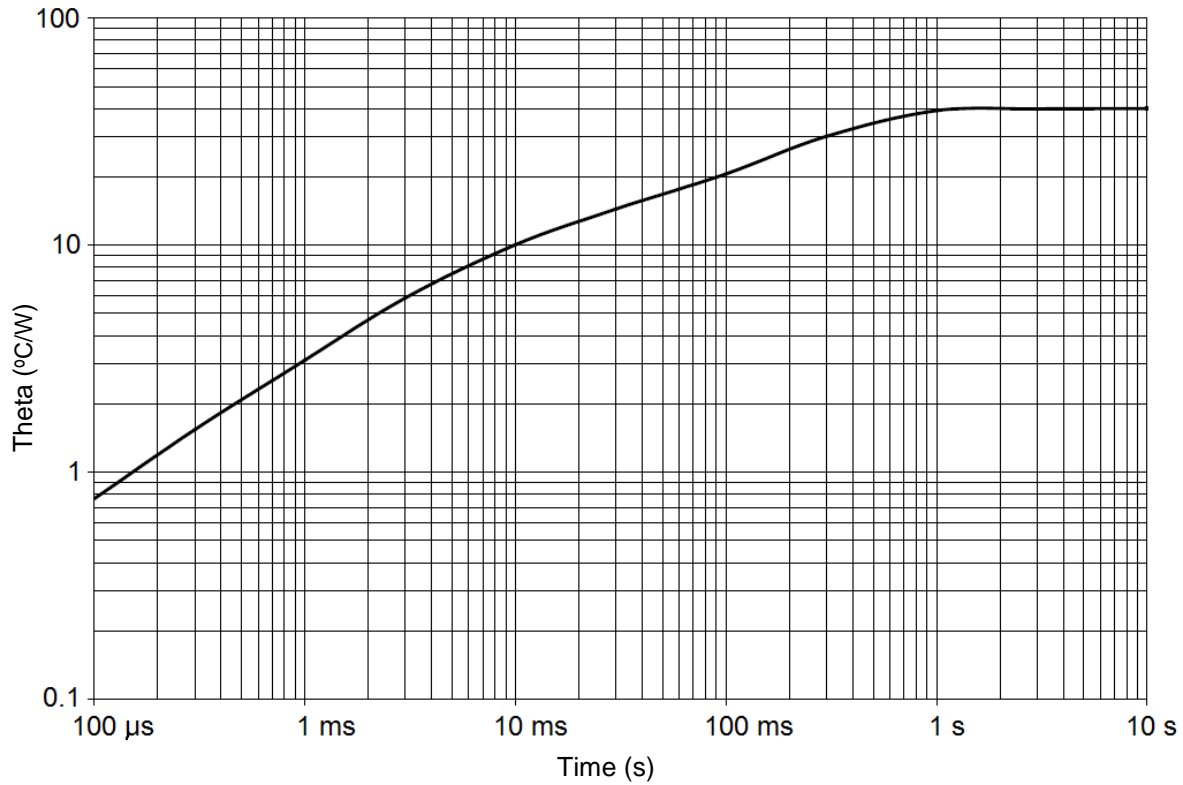
**GRAPHS (continued)****FIGURE 3**

Thermal impedance for 1N5819UR-1 and 1N6761UR-1 (DO-213AB)

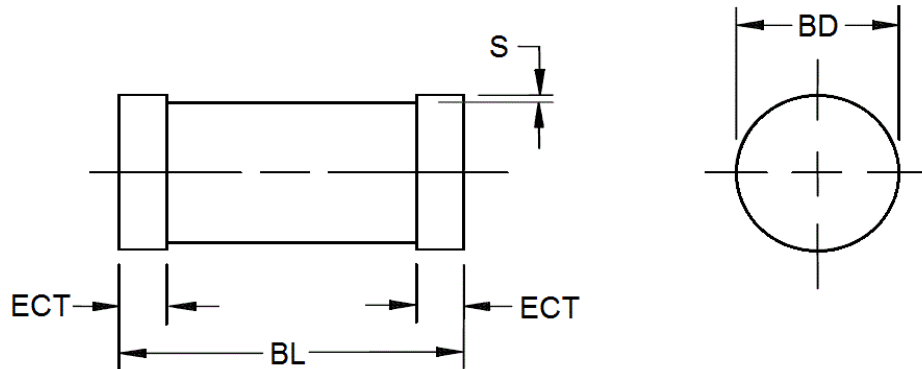
**PACKAGE DIMENSIONS**

Symbol	Dimensions			
	Inch		Millimeters	
	Min	Max	Min	Max
<b>BD</b>	0.094	0.105	2.39	2.67
<b>BL</b>	0.189	0.205	4.80	5.21
<b>ECT</b>	0.016	0.022	0.41	0.56
<b>S</b>	0.001 min		0.03 min	

**NOTES:**

1. Dimensions are in inches. Millimeters are given for information only.
2. Gap not controlled, shape of body and gap not controlled.
3. In accordance with ASME Y14.5M, diameters are equivalent to  $\Phi$ x symbology.

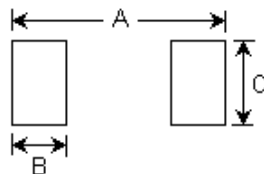
**PAD LAYOUT**

Ltr	Inch	mm
<b>A</b>	0.276	7.00
<b>B</b>	0.070	1.8
<b>C</b>	0.110	2.8