



CMAXQUSB User's Guide

General Description

The Maxim Command Module (CMAXQUSB) receives commands from an IBM PC through the USB to create an SPI™ or SMBus™/I²C-compatible interface. Maxim evaluation kits (EV kits) that make use of the CMAXQUSB require custom software and can be ordered together as an evaluation system (EV system). Ordering information for EV systems is included in the EV kit's corresponding data sheet.

An EV system is an EV kit combined with an interface board such as a CMAXQUSB and custom software. Refer to the appropriate EV kit data sheet for quick start and detailed operating instructions.

The use of the CMAXQUSB as a MAXQ2000 development target is not supported. Rather, use the *MAXQ2000 EV kit* (available at www.maxim-ic.com/MAXQ2000-KIT) for this purpose.

The CMAXQUSB has been tested on Windows® 98 Second Edition, Windows 2000, and Windows XP®.

Features

- ◆ PC-Controlled I/O Platform
- ◆ USB Powered
- ◆ Provides 2.5V, 3.3V, or 5V to EV Kit
- ◆ SPI Bus: 8MHz Burst
- ◆ I²C/2-Wire Bus: Fast 400kHz/Standard 100kHz
- ◆ Optional 1.5kΩ I²C Bus Pullup Resistors

Ordering Information

PART	PC INTERFACE	OPERATING SYSTEMS SUPPORTED
CMAXQUSB+	USB	Windows 98SE/2000/XP

+Denotes lead(Pb)-free and RoHS compliant.

Component List

DESIGNATION	QTY	DESCRIPTION
C1, C2, C3	3	22µF ±10%, 16V X5R ceramic capacitors (1210) TDK C3225X5R1C226K
C4	1	4.7µF ±10%, 10V X7R ceramic capacitor (0805) TDK C2012X5R1A475K
C5	1	0.033µF ±10%, 6.3V (min) X7R ceramic capacitor (0603) TDK C1608X7R1E333K Murata GRM188R71E333K Taiyo Yuden EMK107BJ333KA
C6, C7	2	22pF ±5% C0G ceramic capacitors (0603) TDK C1608C0G1H220J Murata GRM1885C1H220J
C8, C9	2	10pF ±5% C0G ceramic capacitors (0603) Murata GRM1885C1H100J TDK C1608C0G1H100J
C10–C16, C23–C32 (on back of board)	17	0.1µF ±10%, 10V (min) X7R ceramic capacitors (0603) TDK C1608X7R1E104K

DESIGNATION	QTY	DESCRIPTION
C17–C22 (on back of board)	6	1µF, 6.3V (min) X7R ceramic capacitors (0603) TDK C1608X5R0J105K Murata GRM188R60J105K Taiyo Yuden JMK107BJ105MA
D1	1	100V, 1A bridge rectifier (D-70/DIP-6) Diodes Inc. DF005M
J2, J3, JU2–JU5	0	Not installed, 2-pin headers
LED1, LED2	2	Red LEDs (T1-3/4) Panasonic LN21RPH
LED3	1	Yellow (amber) LED (T1-3/4) Panasonic LN41YPH
LED4	1	Green LED (T1-3/4) Panasonic LN31GCPH
P2	1	USB type-B, right-angle PC-mount receptacle
P3	1	20-pin (2 x 10) right-angle male header
P4	1	40-pin (2 x 20) right-angle male header
P5 (JTAG)	1	10-pin (2 x 5) vertical header, keyed pin 7

SPI is a trademark of Motorola, Inc.

SMBus is a trademark of Intel Corp.

Windows and Windows XP are registered trademarks of Microsoft Corp.

For pricing, delivery, and ordering information, please contact Maxim Direct at 1-888-629-4642, or visit Maxim's website at www.maxim-ic.com.

Evaluates: SPI and SMBus/I²C-Compatible Parts

CMAXQUSB User's Guide

Evaluates: SPI and SMBus/I²C-Compatible Parts

Component List (continued)

DESIGNATION	QTY	DESCRIPTION
P1	0	Not installed (2mm power jack)
P6	1	3-pin header
P7	1	4-pin header
P8	1	6-pin header
R1	1	2.2k Ω \pm 5% resistor (1206)
R2, R5, R6	3	1.5k Ω \pm 5% resistors (1206)
R7, R8–R11	5	470k Ω \pm 5% resistors (1206)
R12, R13	2	27 Ω \pm 5% resistors (1206)
R14	1	10k Ω \pm 5% resistor (1206)
R18	1	4.7k Ω \pm 5% resistor (1206)
R19	1	100k Ω \pm 5% resistor (1206)
SW1	1	2-circuit DIP switch (DIP-4)
U1	1	Low-power microcontroller (68 QFN) Maxim MAXQ2000-RAX+
U2	1	FTDI FT232BL (32 TQFP, 7mm x 7mm)
U3	1	LDO linear regulator (5 SC70) Maxim MAX8511EXK25+T (Top Mark: ADV)
U4	1	93C46 type 3-wire EEPROM (8 SO) 16-bit architecture
U5	1	Low-voltage, p-channel MOSFET (8 SO) Maxim MAX890LESA+
U6, U7, U8	3	8-channel level translators (20 TSSOP) Maxim MAX3001EEUP+

DESIGNATION	QTY	DESCRIPTION
U9	1	Low-voltage level translator (8 SOT23) Maxim MAX3373EKA+T (Top Mark: AAKS)
U10	1	Low-voltage level translator (14 TSSOP) Maxim MAX3390EEUD+
U11	1	LDO linear regulator (5 SC70) Maxim MAX8511EXK33+T (Top Mark: AEI)
Y1	1	16MHz crystal (HC49/US) Parallel resonant, 20pF load Suntsu SCS20B-16.000MHz-I
Y2	1	6MHz crystal (HC49/US) Parallel resonant, 20pF load Suntsu SCS22B-6.000MHz-I
Y3	0	Not installed, 32.768kHz crystal
—	1	Vertical header 2 x 3 pins
—	4	Rubber bumpers, 0.100in H x 0.400in W square
—	1	USB high-speed A-to-B cable, 5ft (1.5m)
—	1	Shunt
—	1	PCB: COMMAND MODULE (CMAXQUSB)

CMAXQUSB User's Guide

Component Suppliers

SUPPLIER	PHONE	WEBSITE
Murata Electronics North America, Inc.	770-436-1300	www.murata-northamerica.com
Panasonic Corp.	800-344-2112	www.panasonic.com
Suntsu Frequency Control	949-305-0220	www.suntsuinc.com
Taiyo Yuden	800-348-2496	www.t-yuden.com
TDK Corp.	847-803-6100	www.component.tdk.com

Note: Indicate that you are using the CMAXQUSB or MAXQ2000 when contacting these component suppliers.

Quick Start

Maxim EV systems whose ordering number ends in EVCMAXQU are two-board sets, comprising a CMAXQUSB interface board and an EV kit board specific to the device being evaluated. For example, the MAX6870EVCMAXQU would be a two-board set consisting of the MAX6870EVKIT and the CMAXQUSB. The following generic quick start procedure assumes that the CMAXQUSB board will be used with a companion EV kit.

Required Equipment

- Any Maxim EV system with the EVCMAXQU suffix, such as the MAX6870EVCMAXQU
 - Device-specific EV kit board
 - CMAXQUSB interface board
 - USB type A-to-B cable (*included with the CMAXQUSB*)
- Computer running Windows 98SE/2000/XP with a spare USB port

Administrator privileges may be required when first installing the device on Windows 2000/XP.

Procedure

Do not turn on the power until all connections are complete.

- Select 2.5V, 3.3V, or 5V logic by setting the CMAXQUSB **VDD SELECT** jumper. See the *Jumper Tables* section.
- Ensure that the companion EV kit board's jumper settings are correct. Refer to your companion EV kit's documentation.
- Connect the boards together.
- Install the evaluation software on your computer by running the INSTALL.EXE program on the installation disk. The program files are copied and icons are created for them in the Windows **Start** menu.
- Connect the USB cable between the CMAXQUSB and the computer. When you plug in the CMAXQUSB

board for the first time, the Windows plug-and-play system detects the new hardware and automatically runs the Add New Hardware Wizard (if the Add New Hardware Wizard does not appear after a minute, unplug the board from the USB and plug it in again). Make certain to specify the search location. Maxim software designed for CMAXQUSB includes a copy of the device driver in the installed software directory. Refer to Application Note 3601: *Troubleshooting Windows Plug-and-Play and USB for Maxim Evaluation Kits* for more details.

- During device driver installation, Windows XP shows a warning message indicating that the device driver Maxim uses does not contain a digital signature. This is not an error condition and it is safe to proceed with the installation.
- Start the EV kit software by clicking its icon in the Windows **Start** menu.
- Refer to the companion EV kit's documentation for further instructions demonstrating its custom software.

Detailed Description of Hardware

The low-voltage RISC microcontroller, MAXQ2000-RAX (U1), processes commands sent by a program running on the PC. Each particular EV kit has its own custom software specific to that kit.

The FTDI FT232BM (U2) provides the USB engine. The USB 5V power is regulated down to 3.3V by U11 and down to 2.5V by U3. LED1 indicates USB 5V power is present. LED2, LED3, LED4 are general-purpose indicators.

Level translators U6–U10 convert the MAXQ2000's 2.5V logic signals to the external VDD logic level, which is jumper-selectable for 2.5V, 3.3V, or 5V logic. U9, the MAX3372, is a bidirectional level translator specially designed for the I²C bus. DIP switch SW1 optionally disables the on-board 1.5k Ω termination resistors, allowing the use of external, user-supplied I²C pullup resistors. Level translator U10 is designed for SPI.

CMAXQUSB User's Guide

Connectors P3 and P4 are designed to allow hardware compatibility with previous Maxim EV kit module designs. Headers P7 and P8 allow convenient probing of SMBus/I²C and SPI bus signals.

Connector P5 is used during factory test to program the MAXQ2000 in-circuit using the JTAG interface. The connector pinout is compatible with the MAXQ2000 EV kit's MAXQ-JTAG-001 board.

Platform Capabilities and Limitations

General-Purpose Input and Output (GPIO) Pins

LED1 is lit when VDD is powered. LED2, LED3, and LED4 are general-purpose software-controlled indicators, which also connect to GPIO lines. When driven as inputs, the output impedance should be less than 6000Ω.

SMBus/I²C/2-Wire Interface

The CMAXQUSB module offers "bit-banged" I²C at 400kHz (full speed, the default) or 100kHz (slow speed). Optional user-switchable SCL/SDA pullup resistors are provided on-board. Your PC and its software limits attainable throughput. The SMBus/I²C bus runs in bursts at rated speed, but there is some variable "dead time" between transfers due to communications overhead. Properly written PC software can minimize this dead time but cannot completely eliminate it.

SPI/3-Wire Interface

The CMAXQUSB module offers SPI at up to 8MHz, using the default pin configuration. All four CPOL/CPHA modes are supported. Your PC and its software limits attainable throughput. The SPI bus runs in bursts at rated speed, but there is some variable "dead time" between transfers, due to communications overhead. Properly written PC software can minimize this dead time but cannot completely eliminate it.

Power Supply

The CMAXQUSB is powered by the host PC's universal serial bus (USB). The VDD system voltage can be configured for direct USB 5V power, 3.3V, or 2.5V using one of two on-board linear regulators. An optional external 9V DC plug-in transformer ("wall wart") can be connected for any EV kit board that requires this unregulated 9V DC power supply. Both the unregulated 9V DC and regulated VDD power-supply voltages are provided to the EV kit board on the 2 x 10 (P3) and 2 x 20 (P4) connectors. Current available to a companion EV kit is 80mA.

During USB suspend, the FT232BM drives the MAX890 into a partially powered mode, bringing VDD up to

approximately 1.8V. No commands are sent to the firmware during this mode, so there is no impact. However, custom designs not requiring USB suspend should consider removing the MAX890 to avoid this problem.

Scripting and Data Acquisition

The CMAXQUSB can store a script of commands in its internal memory to eliminate communication "dead time." A script may be repeated up to 256 times, but branching and decision making are not supported. A script may also have a maximum of 126 command/data bytes. Up to 1024 bytes of data may be collected.

SMBus/I²C/2-Wire Bus Pullup Resistors

SMBus/I²C requires a pullup resistor on both SCL and SDA. The CMAXQUSB provides 1.5kΩ pullup resistors, enabled by setting both circuits of DIP switch SW1 "ON." If there are pullup resistors already on the bus, disable the CMAXQUSB's pullup resistors by setting both circuits of SW1 "OFF."

Jumper Tables

JUMPER	POSITION	FUNCTION
JU1 VDD SELECT	2.5V	V _{DD} = 2.5V
	3.3V	V _{DD} = 3.3V
	5V	V _{DD} = 5V
J2 (underneath SW1)	Open	Factory assembly option: replaces SW1-1.
J3 (underneath SW1)	Open	Factory assembly option: replaces SW1-2.
JU2	Closed	Connects MAXQ2000 P6.2 to P6.3, supporting the Maxim 1-Wire® interface.
JU4	Open	JTAG connector P5 does not connect to the +5V supply.
	Closed	JTAG connector P5 connects to the +5V supply.
JU5	Open	Optional higher voltage unregulated power supply is left unconnected; connector P1 is not used.
	Closed	Enable optional unregulated power supply from P1 to connectors P3 and P4.

1-Wire is a registered trademark of Maxim Integrated Products, Inc.

CMAXQUSB User's Guide

Evaluates: SPI and SMBus/I²C-Compatible Parts

Connector P3

Connector P3 is a 20-pin, dual-row header that connects to SMBus/I²C-based kits. The pinout is compatible with Maxim's previous SMBus/I²C solution, the MAXSMBus board. See Table 1.

If designing a custom EV kit board, beware: **the ground return system does not connect pin 20.**

Connector P4

Connector P4 is a 40-pin, dual-row header that connects to SPI and 8-bit parallel kits. The pinout is compatible with Maxim's previous SPI solution, the 68HC16MODULE board. See Table 2.

GPIO pins K1–K8 and K1'–K15' must be driven with a 4.7k Ω or lower impedance source to turn around the bidirectional level translators.

Table 1. Connector P3 Description

P3 PIN	LABEL	FUNCTION
1	VDD	Power Supply. 2.5V, 3.3V, or 5V selected by CMAXQUSB VDD select jumper.
2, 4, 5, 6, 8, 10, 12, 14, 16, 18, 19	GND	Ground Return
3	SDA	SMBus/I ² C SDA (Data)
7	SCL	SMBus/I ² C SCL (Clock)
9	K6	General-Purpose I/O Designated as K6. Can be used for SMBus SUSPEND output.
11	K1	General-Purpose I/O Designated as K1. Can be used for SMBus ALERT input.
13	K2	General-Purpose I/O Designated as K2
15	K3	General-Purpose I/O Designated as K3
17	K4	General-Purpose I/O Designated as K4
20	+12V*	Optional Unregulated Higher Voltage (7.5V to 16.5V) Power Supply. Enabled only if CMAXQUSB jumper JU5 is installed and closed, and if external power is applied through connector P1.

*This +12V signal is provided only for legacy systems and is normally unpowered.

Table 2. Connector P4 Description

P4 PIN	LABEL	GPIO DESIGNATOR	FUNCTION
1–4	GND	—	Ground Return
5, 6	+12V*	—	Optional Unregulated Higher Voltage (7.5V to 16.5V) Power Supply. Enabled only if CMAXQUSB jumper JU5 is closed, and if external power is applied through connector P1.
7, 8	VDD	—	Power Supply. 2.5V, 3.3V, or 5V selected by CMAXQUSB VDD select jumper.
9	\overline{RD}	K13 when K0 = 1	Active-Low Read Strobe
10	\overline{WR}	K14 when K0 = 1	Active-Low Write Strobe
11	$\overline{CS0}$	K15 when K0 = 1	Active-Low Memory Chip-Select Strobe
12, 13, 14	—	—	No Connection. Reserved for additional memory chip-select strobes.
15	A0	K9 when K0 = 1	Memory Address LSB
16	A1	K10 when K0 = 1	Memory Address
17	A2	K11 when K0 = 1	Memory Address
18	A3	K12 when K0 = 1	Memory Address MSB
19	D0	K1 when K0 = 1	Memory Data LSB

*This +12V signal is provided only for legacy systems and is normally unpowered.

CMAXQUSB User's Guide

Table 2. Connector P4 Description (continued)

P4 PIN	LABEL	GPIO DESIGNATOR	FUNCTION
20	D1	K2 when K0 = 1	Memory Data
21	D2	K3 when K0 = 1	Memory Data
22	D3	K4 when K0 = 1	Memory Data
23	D4	K5 when K0 = 1	Memory Data
24	D5	K6 when K0 = 1	Memory Data
25	D6	K7 when K0 = 1	Memory Data
26	D7	K8 when K0 = 1	Memory Data MSB
27	K1	K1	General-Purpose I/O
28	K2	K2	General-Purpose I/O
29	K3	K3	General-Purpose I/O
30	K4	K4	General-Purpose I/O
31	K5	K5	General-Purpose I/O
32	K6	K6	General-Purpose I/O
33	K7	K7	General-Purpose I/O
34	K8	K8	General-Purpose I/O
35	MISO	K11	SPI Master-In, Slave-Out (MISO) Data
36	MOSI	K12	SPI Master-Out, Slave-In (MOSI) Data
37	SCLK	K10	SPI Clock
38	CS	K9	SPI Chip Select. Configurable active high or active low.
39	OW	K15	General-Purpose I/O, Maxim 1-Wire Bus
40	—	—	No Connection

*This +12V signal is provided only for legacy systems and is normally unpowered.

Connector P5: JTAG Debug/Programming Interface

Connector P5 is used during factory test to program the firmware into the MAXQ2000. This connector pinout is identical to the MAXQ2000 EV kit, MAXQ2000-KIT. See Table 3.

Table 3. Connector P5 Description

P5 PIN	LABEL	FUNCTION
1	TCK	TCK to MAXQ2000 Test Access Port (P4.0)
2, 10	GND	Ground Return
3	TDO	TDO to MAXQ2000 Test Access Port (P4.3)
4	VDDIO	MAXQ2000 VDDIO Power Supply
5	TMS	TMS to MAXQ2000 Test Access Port (P4.2)
6	RESET	Active-High Reset to MAXQ2000
7	KEY	No Connection. Pin is physically removed.
8	+5V	Optional +5V Connection
9	TDI	TDI from MAXQ2000 Test Access Port

Connector P6: Maxim 1-Wire Interface

Although there are currently no mating EV kits that use this feature, the MAXQ2000's 1-Wire interface signal connects to header P6. See Table 4.

Table 4. Connector P6 Description

P6 PIN	LABEL	FUNCTION
1	VDD	VDD Power Supply
2	OW	Maxim 1-Wire Interface, Through Level Translator U6
3	GND	Ground Return

CMAXQUSB User's Guide

Connector P7: SMBus/I²C Test Points

For convenience, the SMBus/I²C interface signals are connected to labeled pins on header P7. See Table 5.

Table 5. Connector P7 Description

P7 PIN	LABEL	FUNCTION
1	VDD	VDD Power Supply
2	SDA	SMBus/I ² C SDA (Data)
3	GND	Ground Return
4	SCL	SMBus/I ² C SCL (Clock)

Connector P8: SPI Test Points

For convenience, the SPI interface signals are connected to labeled pins on header P8. See Table 6.

Table 6. Connector P8 Description

P8 PIN	LABEL	FUNCTION
1	VDD	VDD Power Supply
2	MISO	Master-In, Slave-Out Data
3	MOSI	Master-Out, Slave-In Data
4	SCLK	SPI Clock
5	CS	Chip Select. Configurable active high or active low.
6	GND	Ground Return

Detailed Description of Firmware

The CMAXQUSB firmware was developed using the MAX-IDE assembly language development environment. Full source code is available at www.maxim-ic.com/tools/evkit under the project name **CMAXQUSB Firmware**.

If designing a custom EV kit board requiring an interrupt service routine in custom firmware, GPIO signals K5–K8 are the suggested locations for the interrupt signal. The standard CMAXQUSB firmware does not service interrupts on any GPIO pins.

Troubleshooting

Problem: Software reports it cannot find the board.

- Verify that the CMAXQUSB power LED is lit.
- Verify that the USB cable is connected.
- Verify that Windows plug-and-play detected the board. Bring up Control Panel -> System -> Device Manager, and look at what device nodes are indicated for the USB. If there is an “unknown device” node attached to the USB, delete it—this forces plug-and-play to try again.

Problem: Unable to find SMBus/I²C device.

- Verify that the SCL and SDA signals are pulled up to VDD. CMAXQUSB DIP switch SW1 enables the on-board resistors. There must be pullup resistors somewhere on the bus.
- If using wires to connect the CMAXQUSB to your target board, make certain that you have not swapped the SCL and SDA signals. Verify that the ground return is connected.

CMAXQUSB User's Guide

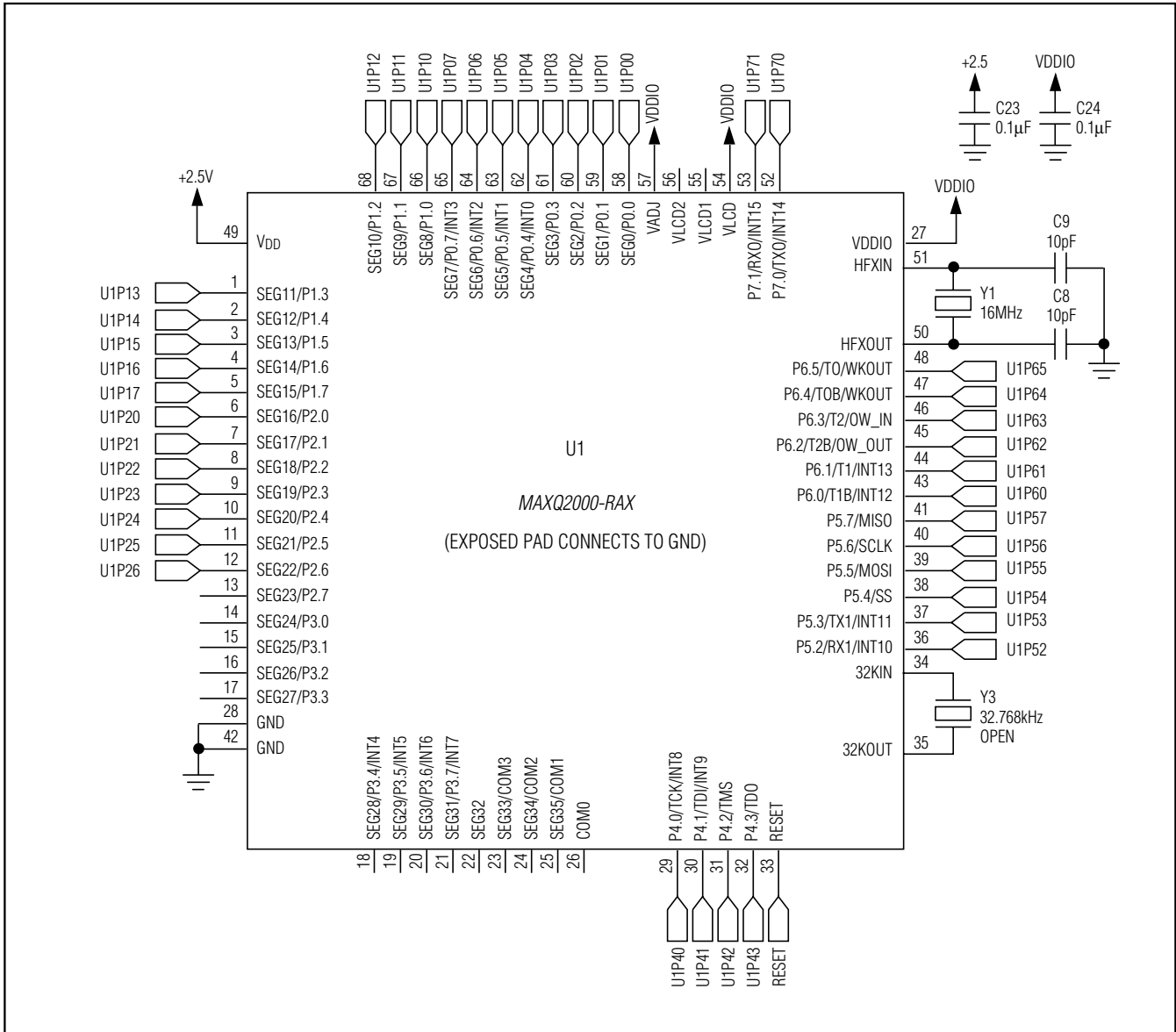

Figure 1a. CMAXQUSB Schematic (Sheet 1 of 4)

Evaluates: SPI and SMBus/I²C-Compatible Parts

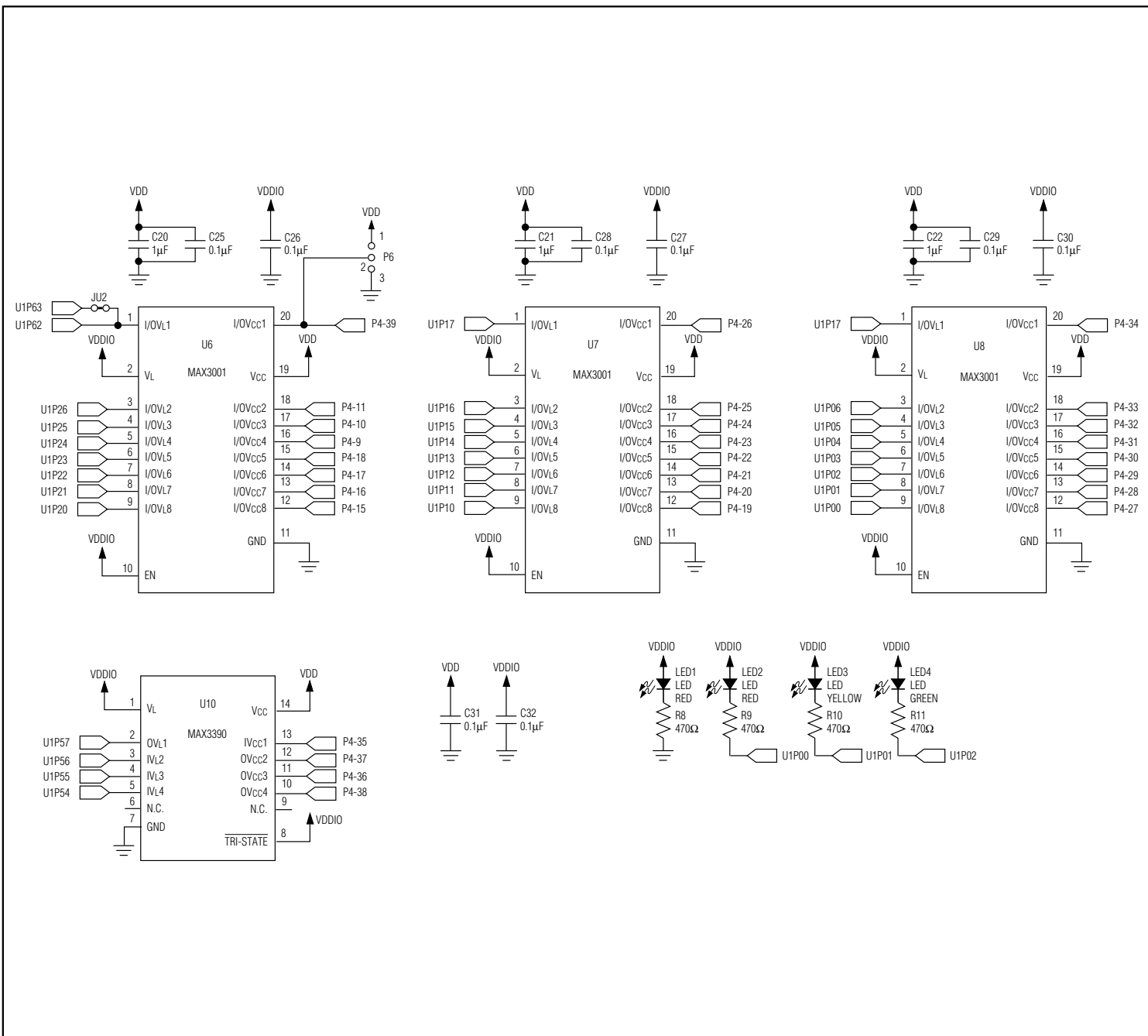
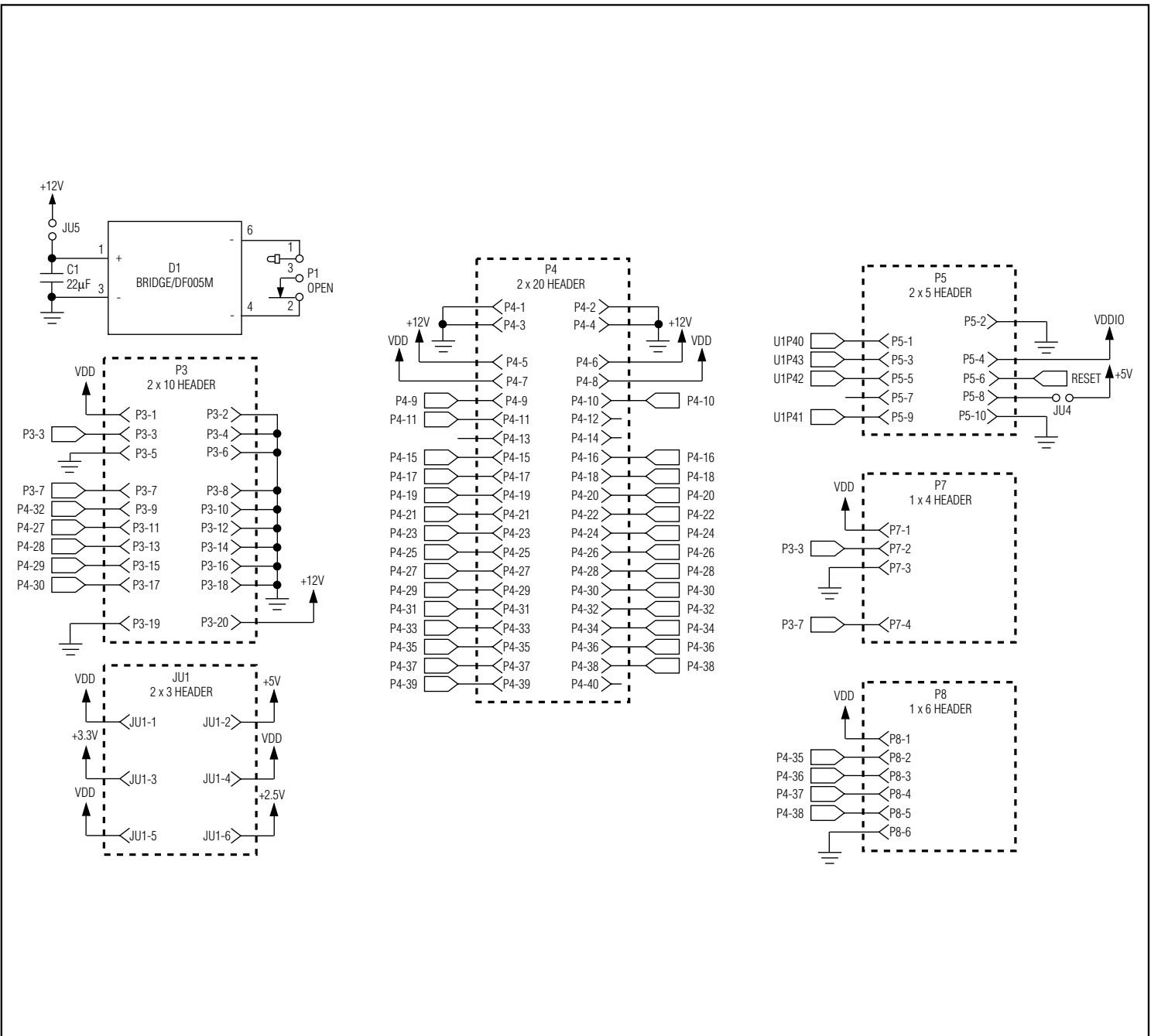

Figure 1c. CMAXQUSB Schematic (Sheet 3 of 4)



Evaluates: SPI and SMBus/I²C-Compatible Parts

Figure 1d. CMAXQUSB Schematic (Sheet 4 of 4)

CMAXQUSB User's Guide

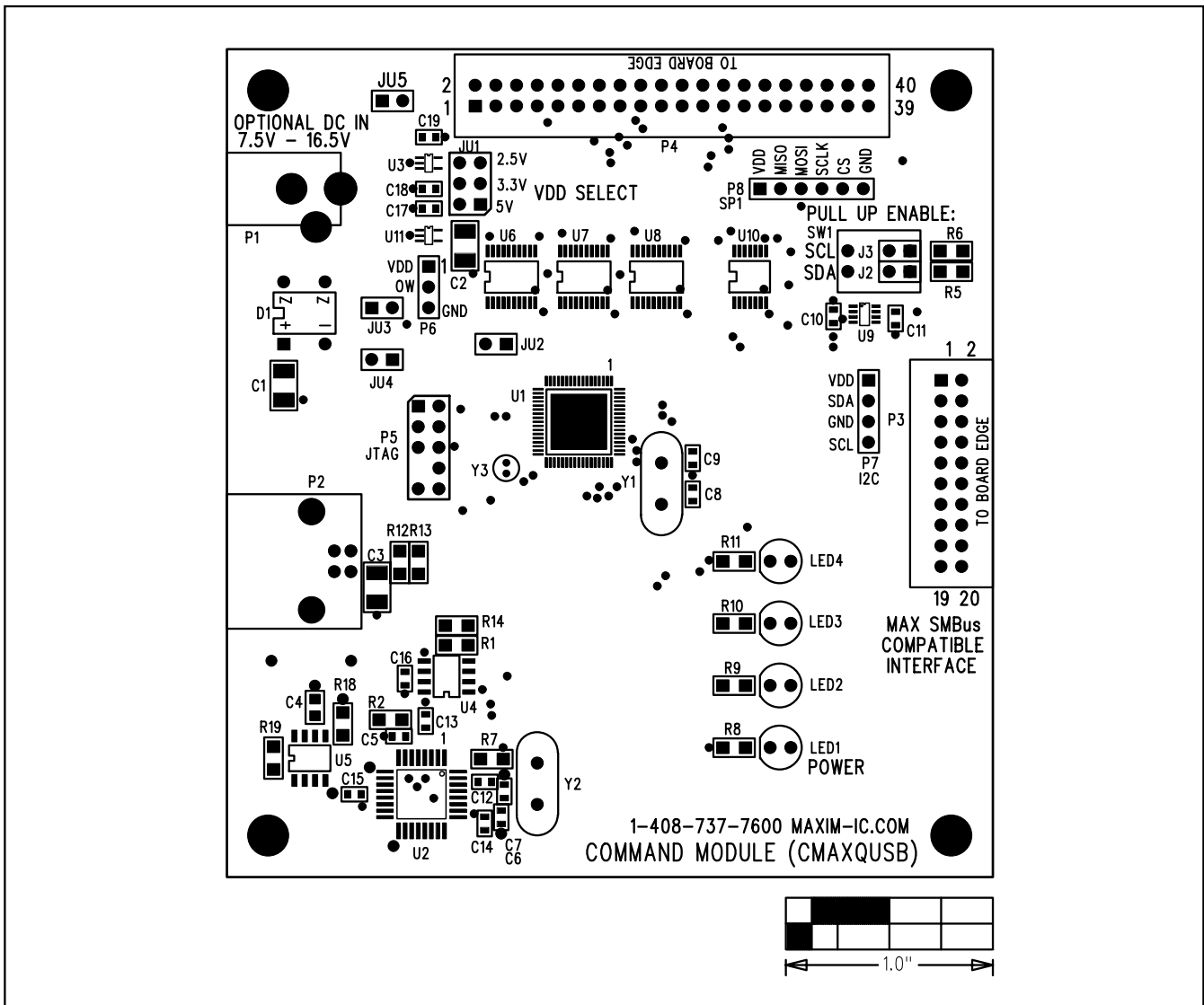

Figure 2. CMAXQUSB Component Placement Guide—Component Side (Top Silkscreen)

CMAXQUSB User's Guide

Evaluates: SPI and SMBus/I²C-Compatible Parts

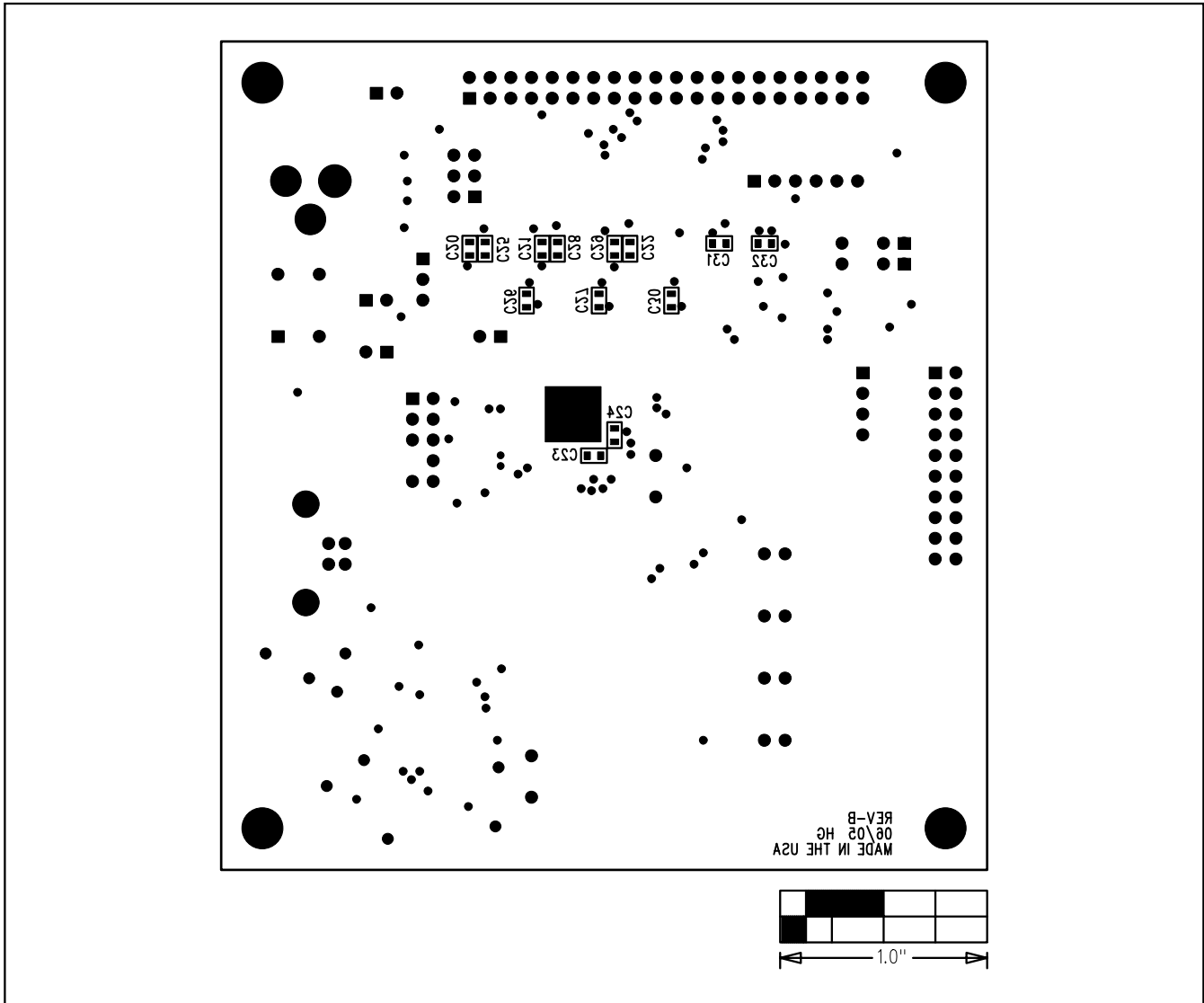

Figure 3. CMAXQUSB Component Placement Guide—Solder Side (Bottom Silkscreen)

CMAXQUSB User's Guide

Evaluates: SPI and SMBus/I²C-Compatible Parts

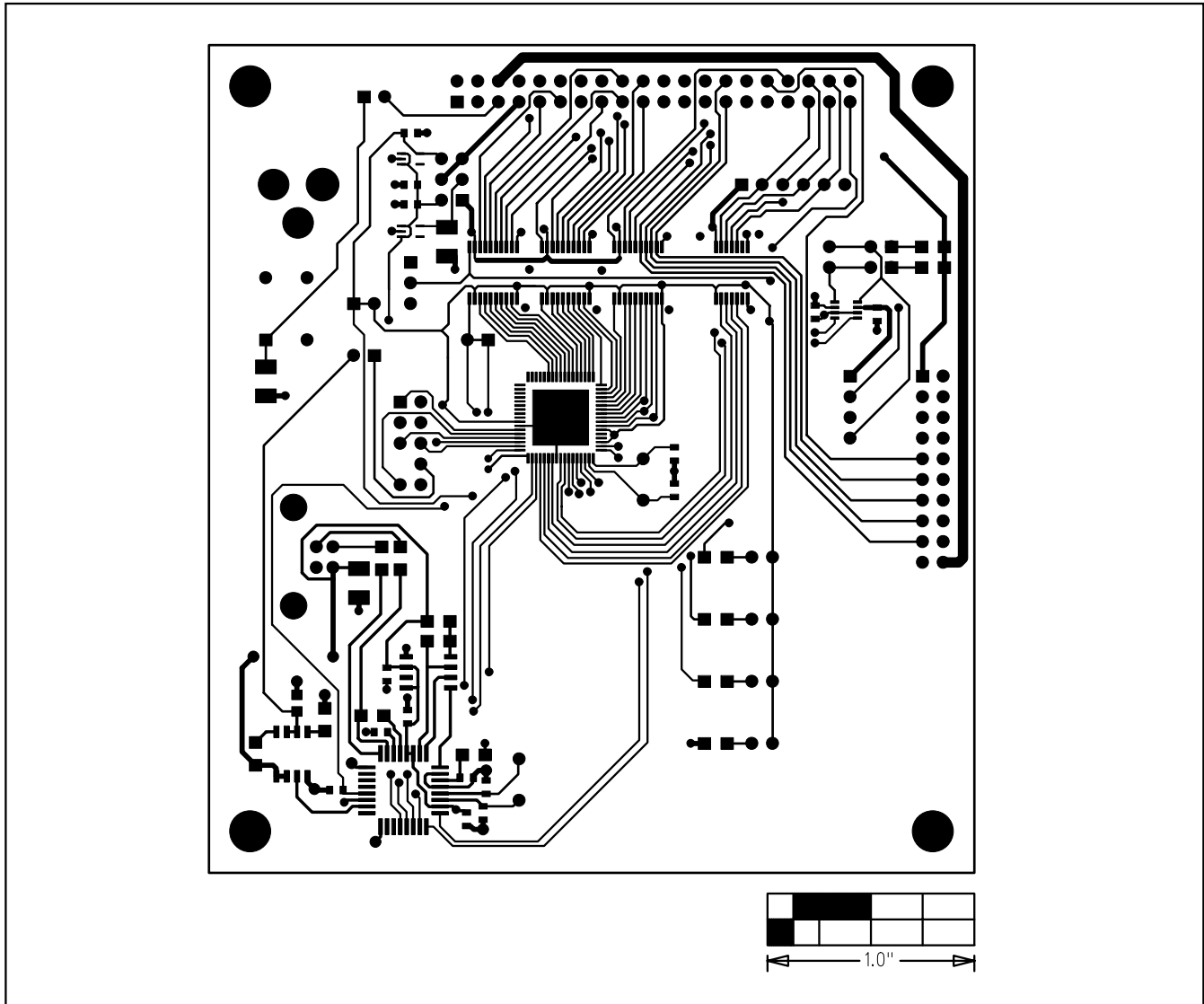

Figure 4. CMAXQUSB PCB Layout—Component Side

CMAXQUSB User's Guide

Evaluates: SPI and SMBus/I²C-Compatible Parts

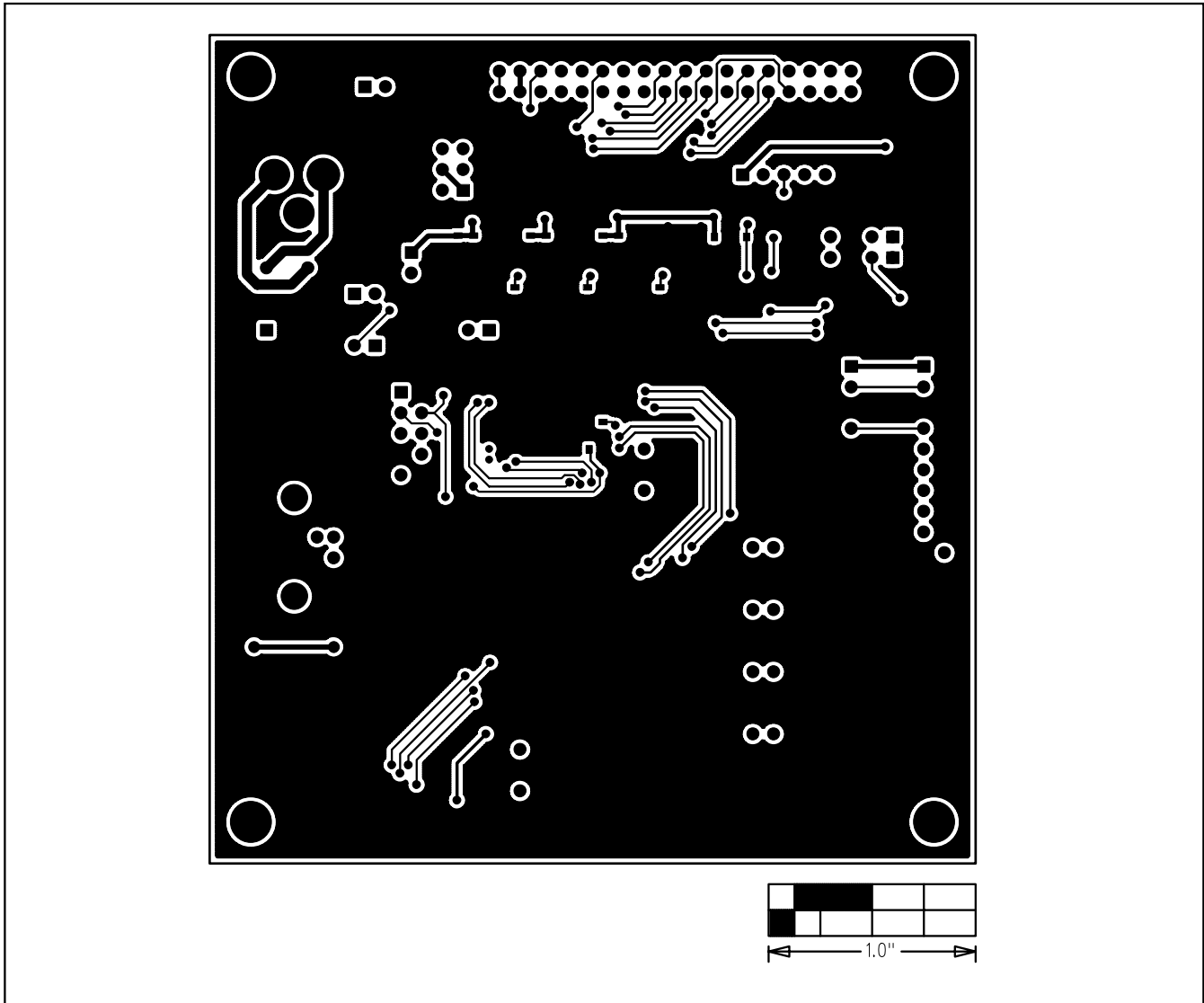

Figure 5. CMAXQUSB PCB Layout—Solder Side

CMAXQUSB User's Guide

Revision History

REVISION NUMBER	REVISION DATE	DESCRIPTION	PAGES CHANGED
2	12/10	Updated Y3 in <i>Component List</i> and Figure 1a	2, 8

Maxim cannot assume responsibility for use of any circuitry other than circuitry entirely embodied in a Maxim product. No circuit patent licenses are implied. Maxim reserves the right to change the circuitry and specifications without notice at any time. The parametric values (min and max limits) shown in the Electrical Characteristics table are guaranteed. Other parametric values quoted in this data sheet are provided for guidance.

16 _____ **Maxim Integrated Products, Inc. 160 Rio Robles, San Jose, CA 95134 USA 1-408-601-1000**