

CTVP Series

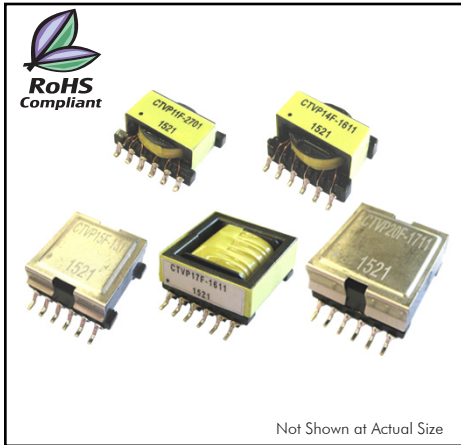

CHARACTERISTICS

Description: SMD six winding transformers and inductors

Applications (Transformer): flyback, feed forward, push-pull, multiple, etc.

Applications (Inductor): buck, boost, coupled, choke, filter, differential, forward, common mode.

Features:

- High efficiency, low profile and low radiation
- Frequency range to over 1MHz
- 500VAC isolation winding to winding
- Can be used as Transformer or Inductor
- Ferrite core material

Operating Temperature: -40°C to +85°C

Storage Temperature: -55°C to +125°C

Solder reflow temperature: +250°C for 10 seconds maximum

Miscellaneous: **RoHS Compliant.**

Samples available. See website for ordering information.

SPECIFICATIONS

Part Number	⁽¹⁾ Inductance Nom. (μ H)	⁽²⁾ Isat Typ. (A)	⁽³⁾ Leakage Inductance Typ. (μ H)	⁽⁴⁾ DCR Max. (Ω)	⁽⁵⁾ Irms Typ. (A)
CTVP11F-2011	201.6 \pm 30%	0.04	0.22	0.35	0.55
CTVP11F-9001	89.6 \pm 30%	0.06	0.10	0.15	0.85
CTVP11F-2701	27.4 \pm 20%	0.29	0.22	0.35	0.55
CTVP11F-1201	12.2 \pm 20%	0.43	0.10	0.15	0.85
CTVP11F-1501	14.7 \pm 20%	0.53	0.22	0.35	0.55
CTVP11F-0651	6.5 \pm 20%	0.80	0.10	0.15	0.85
CTVP11F-1101	10.9 \pm 20%	0.72	0.22	0.35	0.55
CTVP11F-0491	4.9 \pm 20%	1.06	0.10	0.15	0.85
CTVP11F-0851	8.5 \pm 20%	0.92	0.22	0.35	0.55
CTVP11F-0381	3.8 \pm 20%	1.37	0.10	0.15	0.85
CTVP14F-1611	160 \pm 30%	0.07	0.17	0.16	0.95
CTVP14F-7801	78.4 \pm 30%	0.10	0.09	0.09	1.26
CTVP14F-2201	21.6 \pm 20%	0.53	0.17	0.16	0.95
CTVP14F-1101	10.6 \pm 20%	0.76	0.09	0.09	1.26
CTVP14F-1201	11.6 \pm 20%	0.99	0.17	0.16	0.95
CTVP14F-0601	5.7 \pm 20%	1.41	0.09	0.09	1.26
CTVP14F-0831	8.3 \pm 20%	1.39	0.17	0.16	0.95
CTVP14F-0411	4.1 \pm 20%	1.95	0.09	0.09	1.26
CTVP14F-0661	6.6 \pm 20%	1.74	0.17	0.16	0.95
CTVP14F-0321	3.2 \pm 20%	2.50	0.09	0.09	1.26

SPECIFICATIONS

Part Number	⁽¹⁾ Inductance Nom. (μ H)	⁽²⁾ I _{sat} Typ. (A)	⁽³⁾ Leakage Inductance Typ. (μ H)	⁽⁴⁾ DCR Max. (Ω)	⁽⁵⁾ I _{rms} Typ. (A)
CTVP15F-1311	132 \pm 30%	0.07	0.13	0.14	0.97
CTVP15F-6301	63.2 \pm 30%	0.10	0.06	0.06	1.47
CTVP15F-2301	23.3 \pm 20%	0.41	0.13	0.14	0.97
CTVP15F-1101	11.2 \pm 20%	0.59	0.06	0.06	1.47
CTVP15F-1401	14.2 \pm 20%	0.67	0.13	0.14	0.97
CTVP15F-0681	6.8 \pm 20%	0.97	0.06	0.06	1.47
CTVP15F-0931	9.3 \pm 20%	1.02	0.13	0.14	0.97
CTVP15F-0451	4.5 \pm 20%	1.46	0.06	0.06	1.47
CTVP15F-0791	7.94 \pm 20%	1.19	0.13	0.14	0.97
CTVP15F-0381	3.8 \pm 20%	1.73	0.06	0.06	1.47
CTVP17F-1611	159.7 \pm 30%	0.11	0.16	0.09	1.41
CTVP17F-8701	87.0 \pm 30%	0.15	0.08	0.06	1.70
CTVP17F-2401	23.7 \pm 20%	0.65	0.16	0.09	1.41
CTVP17F-1101	11.3 \pm 20%	0.95	0.08	0.06	1.70
CTVP17F-1301	12.7 \pm 20%	1.21	0.16	0.09	1.41
CTVP17F-0601	6.1 \pm 20%	1.75	0.08	0.06	1.70
CTVP17F-1001	10.1 \pm 20%	1.52	0.16	0.09	1.41
CTVP17F-0491	4.9 \pm 20%	2.18	0.08	0.06	1.70
CTVP17F-0791	7.94 \pm 20%	1.94	0.16	0.09	1.41
CTVP17F-0381	3.8 \pm 20%	2.81	0.08	0.06	1.70
CTVP20F-1711	173 \pm 30%	0.14	0.24	0.07	1.70
CTVP20F-7701	76.8 \pm 30%	0.20	0.11	0.05	2.08
CTVP20F-2201	22.3 \pm 20%	1.05	0.24	0.07	1.70
CTVP20F-0991	9.9 \pm 20%	1.60	0.11	0.05	2.08
CTVP20F-1201	12 \pm 20%	1.96	0.24	0.07	1.70
CTVP20F-0531	5.3 \pm 20%	2.95	0.11	0.05	2.08
CTVP20F-0971	9.65 \pm 20%	2.43	0.24	0.07	1.70
CTVP20F-0431	4.3 \pm 20%	3.63	0.11	0.05	2.08
CTVP20F-0761	7.63 \pm 20%	3.07	0.24	0.07	1.70
CTVP20F-0301	3.4 \pm 20%	4.59	0.11	0.05	2.08

NOTES FROM TABLES

1. L(nom) = Nominal Inductance of a single winding.
2. Peak current that will result in 30% saturation of the core. This current value assumes that equal current flows in all six windings.
3. CTVP11F and CTVP14F: Pins 4-1 with other pins shorted.
CTVP15F, CTVP17F and CTVP20F: Pins 1-12 with other pins shorted.
4. Maximum DC Resistance of each winding.
5. RMS current that results in a surface temperature of approximately 40°C above ambient. The 40°C rise occurs when the specified current flows through each of the six windings.

PHYSICAL DIMENSIONS

CTVP11F Series (Unit: mm)

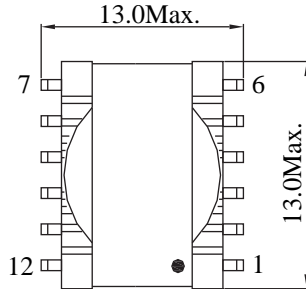

Top View

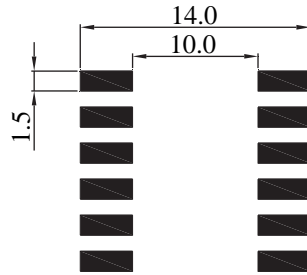

Suggested Pad Layout

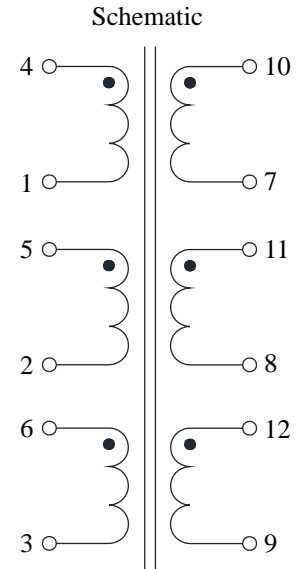
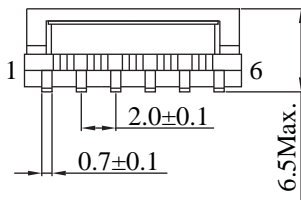

1:1:1:1:1±3%

CTVP14F Series (Unit: mm)

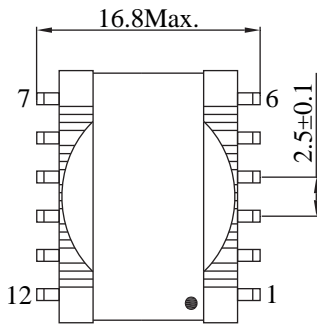

Top View

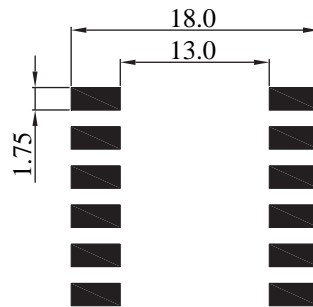

Suggested Pad Layout

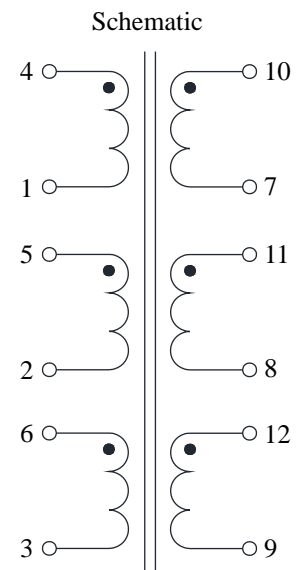
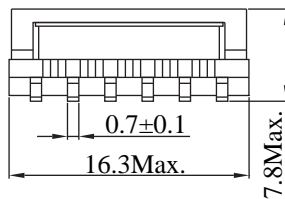

1:1:1:1:1±3%

PHYSICAL DIMENSIONS

CTVP15F Series

(Unit: mm)

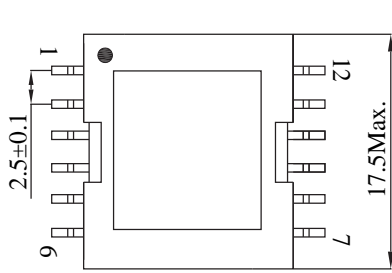

Top View

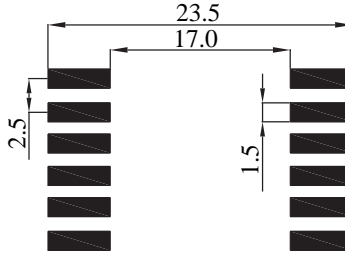

Suggested Pad Layout

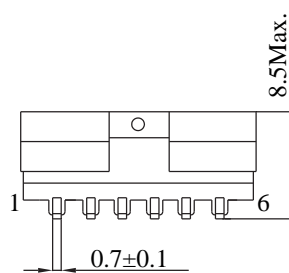
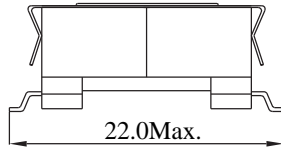

Schematic

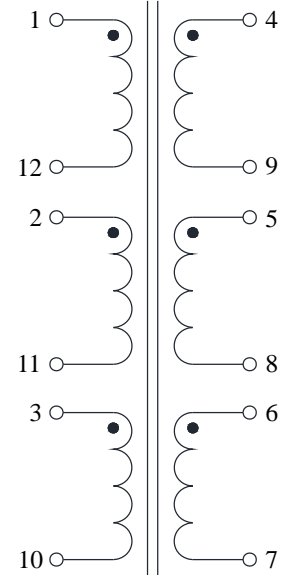

1:1:1:1:1:1±3%

CTVP17F Series

(Unit: mm)

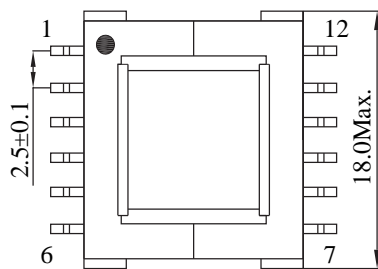

Top View

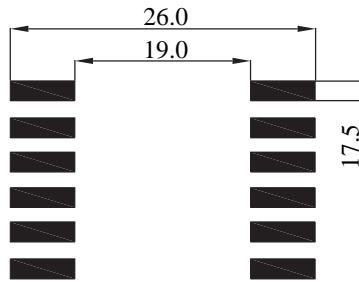

Suggested Pad Layout

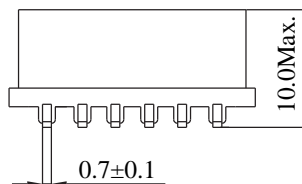
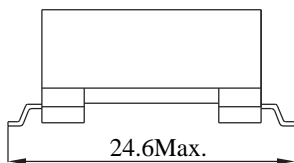

Schematic

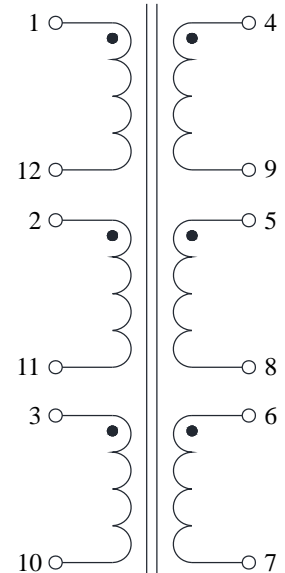

1:1:1:1:1:1±3%

PHYSICAL DIMENSIONS

CTVP20F Series
(Unit: mm)

