

IR OSLUX (810nm) - 20° Version 1.1

SFH 4780S

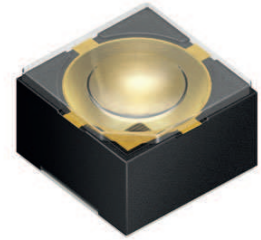

Features:

- IR lightsource with high efficiency
- Double stack emitter
- Low thermal resistance (Max. 25 K/W)
- Centroid wavelength 810 nm
- Narrow half angle (+/- 10°)

Applications

- Infrared Illumination

Notes

Depending on the mode of operation, these devices emit highly concentrated non visible infrared light which can be hazardous to the human eye. Products which incorporate these devices have to follow the safety precautions given in IEC 60825-1 and IEC 62471.

Ordering Information

Type:	Radiant Intensity I_e [mW/sr] $I_F = 1 \text{ A}, t_p = 10 \text{ ms}$	Ordering Code
SFH 4780S	2900 (≥ 2200)	Q65111A6054

Note: measured at a solid angle of $\Omega = 0.001 \text{ sr}$

Maximum Ratings ($T_A = 25\text{ °C}$)

Parameter	Symbol	Values	Unit
Operation and storage temperature range	$T_{op}; T_{stg}$	-40 ... 85	°C
Junction temperature	T_j	145	°C
Reverse voltage	V_R	1	V
Forward current	I_F	500	mA
Surge current ($t_p \leq 200\ \mu\text{s}$, $D = 0$)	I_{FSM}	2	A
Power consumption	P_{tot}	1.8	W
ESD withstand voltage (acc. to ANSI/ ESDA/ JEDEC JS-001 - HBM)	V_{ESD}	2	kV
Thermal resistance junction - solder point	R_{thJS}	25	K / W

Note: For the forward current and power consumption please see "maximum permissible forward current" diagram

Characteristics ($T_A = 25\text{ °C}$)

Parameter	Symbol	Values	Unit
Peak wavelength ($I_F = 1\text{ A}$, $t_p = 10\text{ ms}$)	λ_{peak}	820	nm
Centroid wavelength ($I_F = 1\text{ A}$, $t_p = 10\text{ ms}$)	$\lambda_{centroid}$	810	nm
Spectral bandwidth at 50% of I_{max} ($I_F = 1\text{ A}$, $t_p = 10\text{ ms}$)	$\Delta\lambda$	30	nm
Half angle	φ	± 10	°
Dimensions of active chip area	L x W	0.75 x 0.75	mm x mm
Rise and fall times of I_e (10% and 90% of $I_{e,max}$) ($I_F = 1\text{ A}$, $R_L = 50\ \Omega$)	t_r / t_f	8/ 14	ns
Forward voltage ($I_F = 0.5\text{ A}$, $t_p = 100\ \mu\text{s}$)	V_F	3.3 (≤ 3.6)	V
Forward voltage ($I_F = 1\text{ A}$, $t_p = 100\ \mu\text{s}$)	V_F	3.6	V
Total radiant flux ($I_F = 1\text{ A}$, $t_p = 100\ \mu\text{s}$)	Φ_e	680	mW
Total radiant flux ($I_F = 1\text{ A}$, $t_p = 10\text{ ms}$)	Φ_e	600	mW

Parameter		Symbol	Values	Unit
Temperature coefficient of I_e or Φ_e ($I_F = 1$ A, $t_p = 10$ ms)	(typ)	TC_I	-0.3	% / K
Temperature coefficient of V_F ($I_F = 1$ A, $t_p = 10$ ms)	(typ)	TC_V	-2	mV / K
Temperature coefficient of wavelength ($I_F = 1$ A, $t_p = 10$ ms)	(typ)	TC_λ	0.3	nm / K

Grouping ($T_A = 25$ °C)

Group	Min Radiant Intensity	Max Radiant Intensity	Typ Radiant Intensity
	$I_F = 1$ A, $t_p = 10$ ms $I_{e, \min}$ [mW / sr]	$I_F = 1$ A, $t_p = 10$ ms $I_{e, \max}$ [mW / sr]	$I_F = 1$ A, $t_p = 10$ ms $I_{e, \text{typ}}$ [mW / sr]
SFH 4780S	2200	4400	2900

Note: measured at a solid angle of $\Omega = 0.001$ sr

Only one group in one packing unit (variation lower 2:1).

Relative Spectral Emission ^{1) page 12}

$I_{\text{rel}} = f(\lambda)$, $T_A = 25$ °C, $I_F = 1$ A, Single pulse, $t_p = 10$ ms

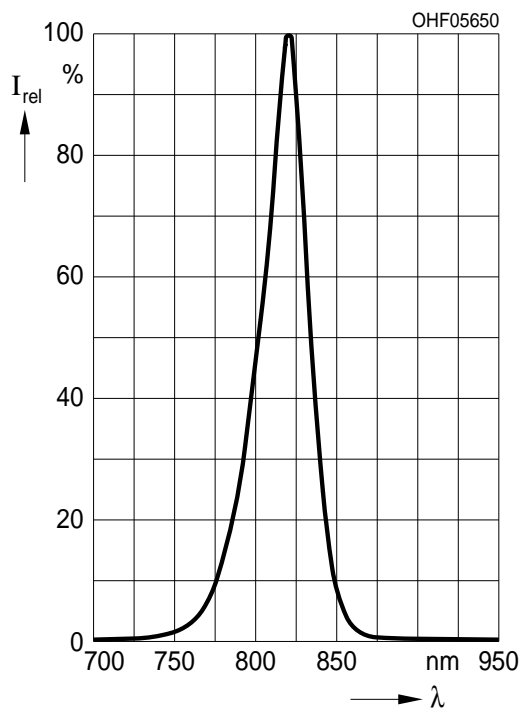

Radiant Intensity ^{1) page 12}

$I_e / I_e(1 \text{ A}) = f(I_F)$, single pulse, $t_p = 100$ μ s, $T_A = 25$ °C

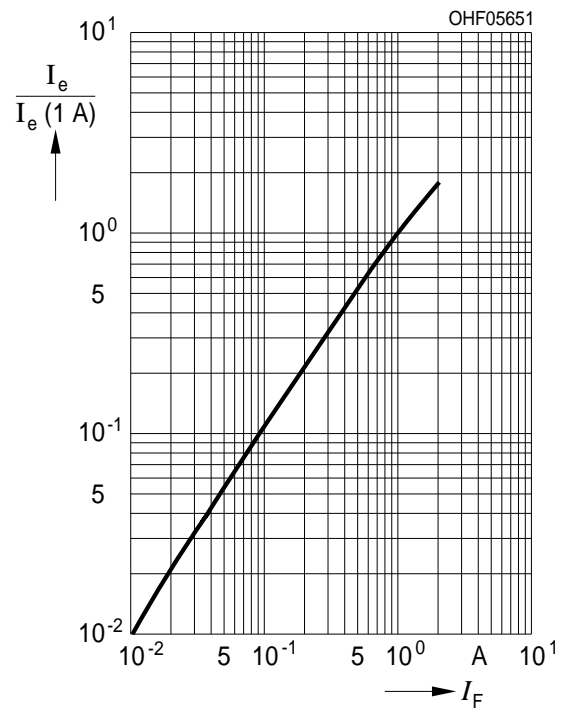

Max. Permissible Forward Current

$I_F = f(T_S), R_{thJS} = 25 \text{ K/W}$

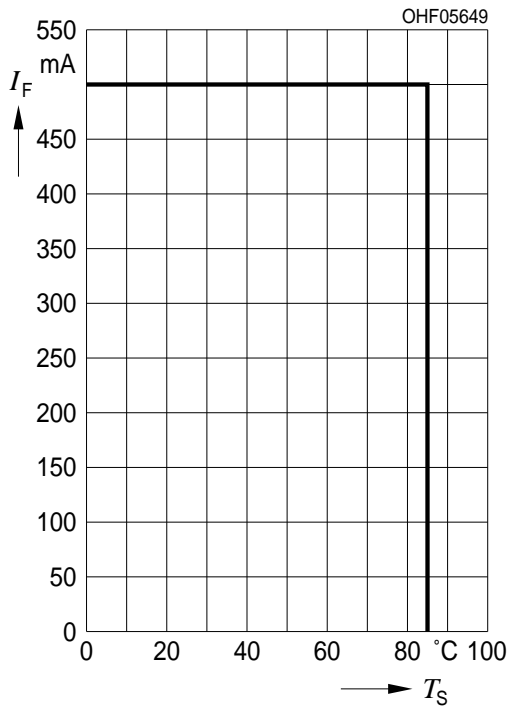

Forward Current ^{1) page 12}

$I_F = f(V_F), T_A = 25^\circ\text{C}, \text{ Single pulse, } t_p = 100 \mu\text{s},$

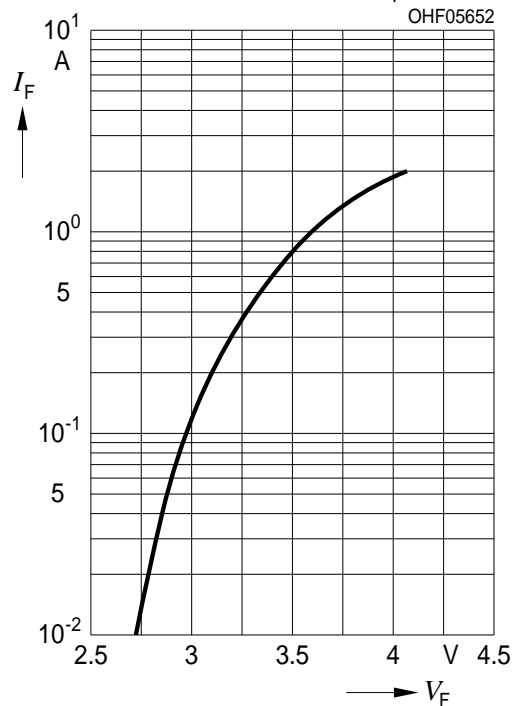

Permissible Pulse Handling Capability

$I_F = f(t_p), T_S = 85^\circ\text{C}, \text{ Duty cycle } D = \text{parameter}$

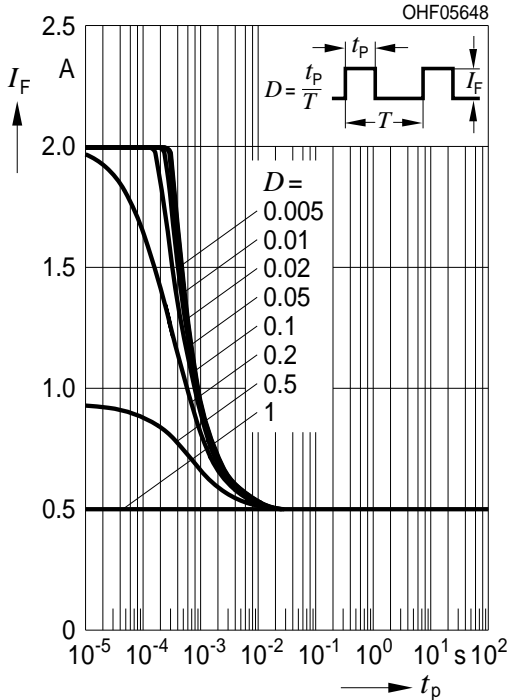

Radiation Characteristics ^{1) page 12}

$I_{rel} = f(\phi), T_A = 25^\circ C$

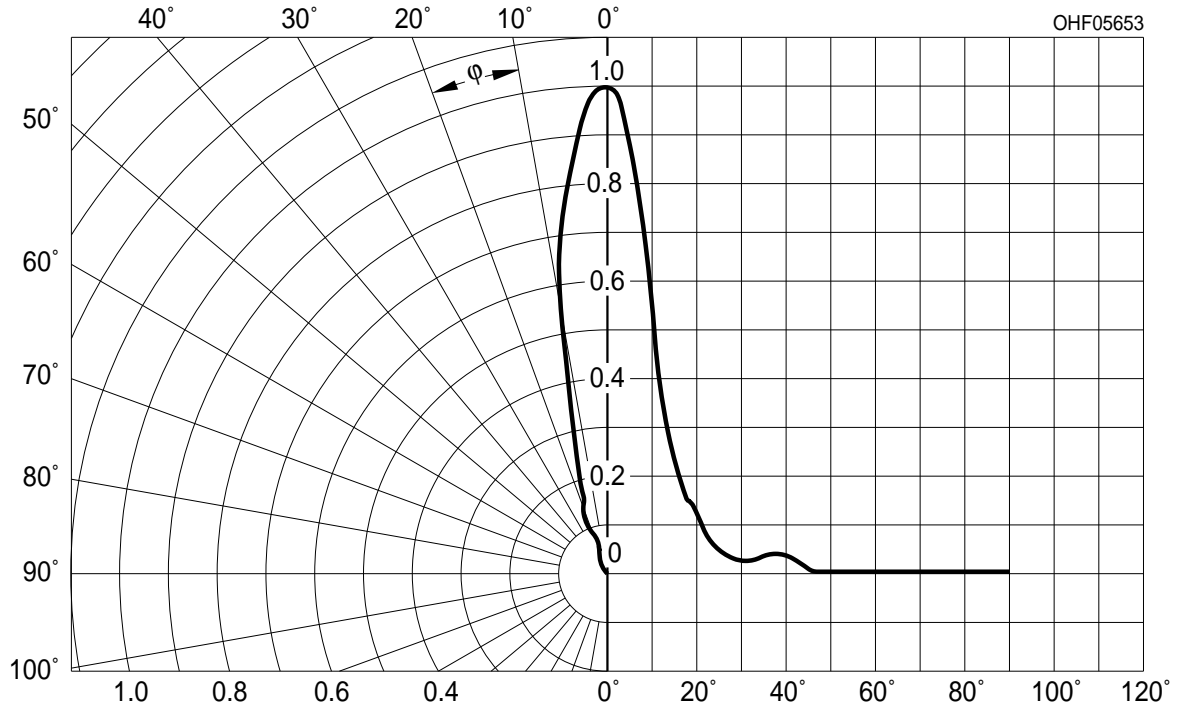

Package Outline

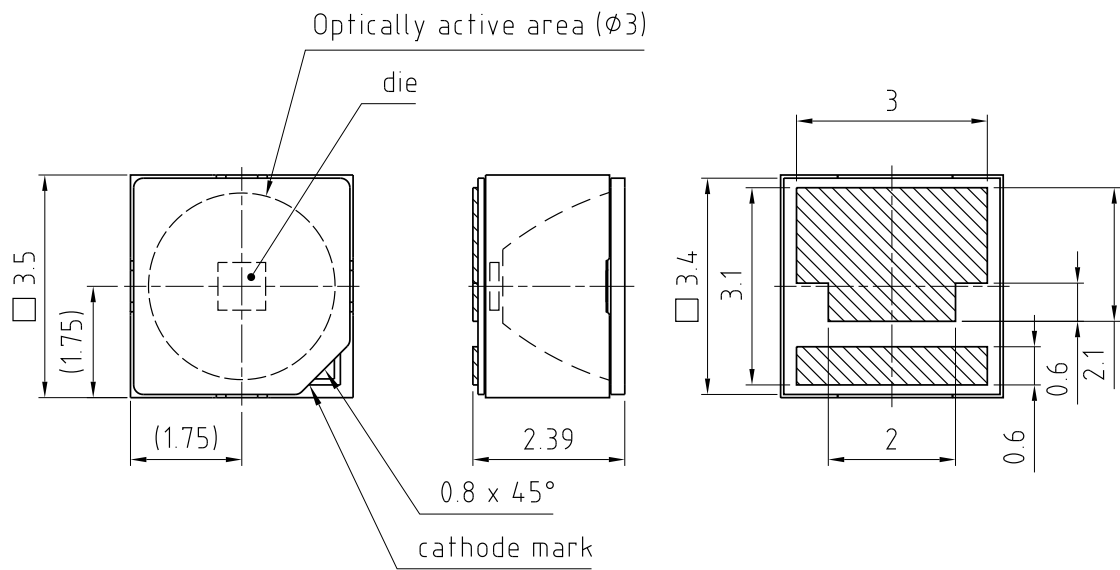

general tolerance ± 0.1

lead finish Au

E062.5594.08-02

Dimensions in mm.

Package
IR OSLUX

Approximate Weight:

32 mg

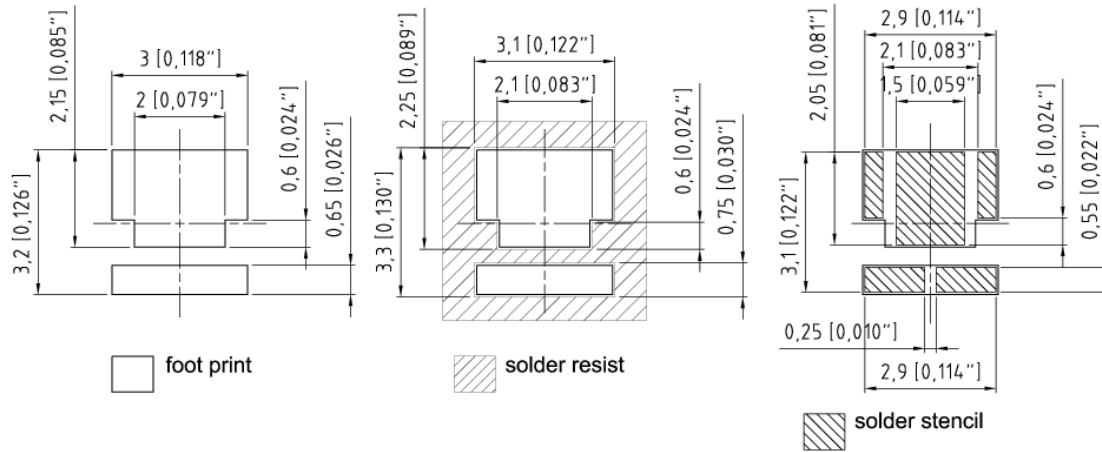
Recommended Solder Pad*Dimensions in mm [inch].*

Reflow Soldering Profile

Product complies to MSL Level 3 acc. to JEDEC J-STD-020D.01

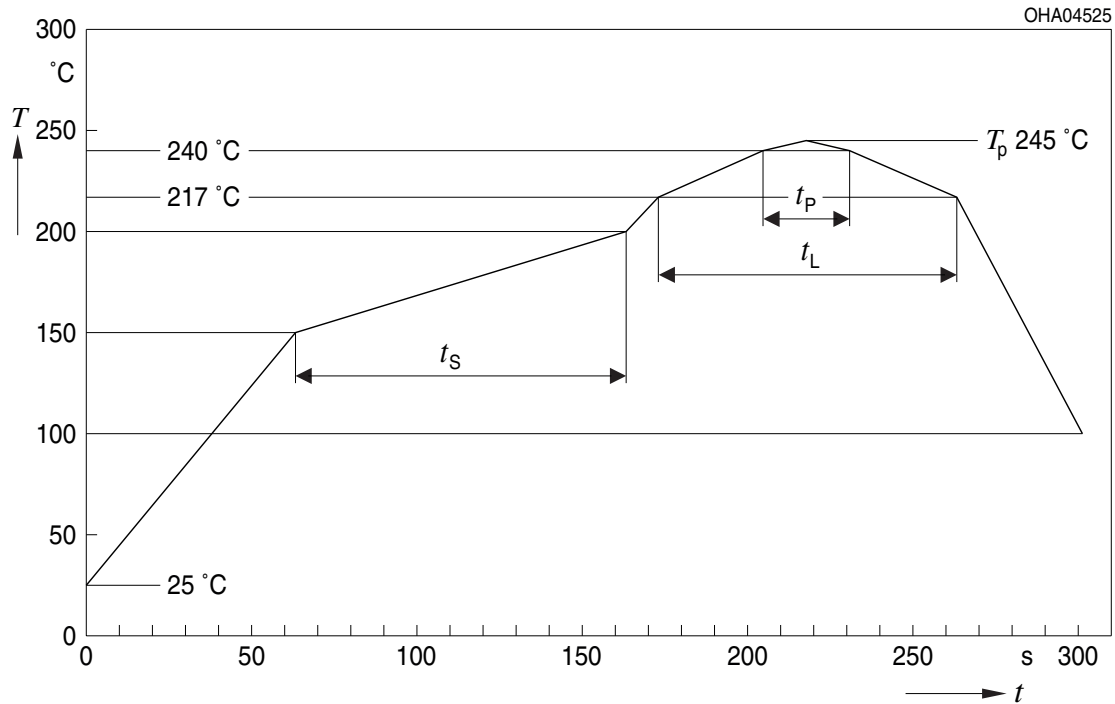

OHA04612

Profile Feature Profil-Charakteristik	Symbol Symbol	Pb-Free (SnAgCu) Assembly			Unit Einheit
		Minimum	Recommendation	Maximum	
Ramp-up rate to preheat*) 25 °C to 150 °C			2	3	K/s
Time t_s T_{Smin} to T_{Smax}	t_s	60	100	120	s
Ramp-up rate to peak*) T_{Smax} to T_p			2	3	K/s
Liquidus temperature	T_L		217		°C
Time above liquidus temperature	t_L		80	100	s
Peak temperature	T_p		245	260	°C
Time within 5 °C of the specified peak temperature $T_p - 5$ K	t_p	10	20	30	s
Ramp-down rate* T_p to 100 °C			3	6	K/s
Time 25 °C to T_p				480	s

All temperatures refer to the center of the package, measured on the top of the component

* slope calculation DT/Dt : Dt max. 5 s; fulfillment for the whole T-range

Taping

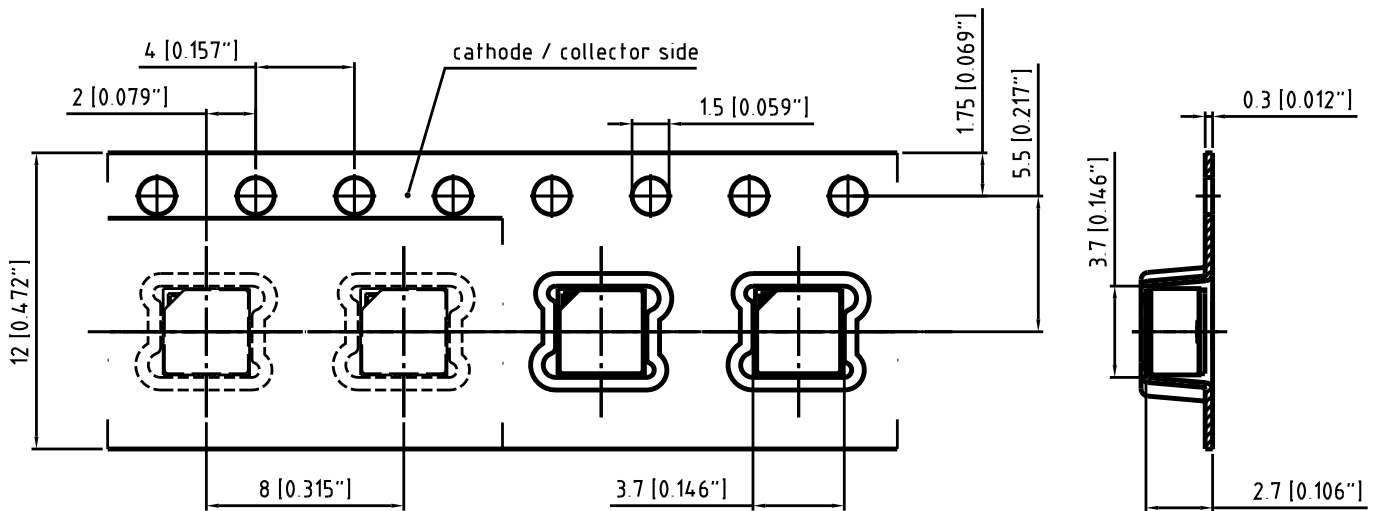

C63062-A4242-B1-03

Dimensions in mm [inch].

Tape and Reel

12 mm tape with 2500 pcs. on Ø 330 mm reel

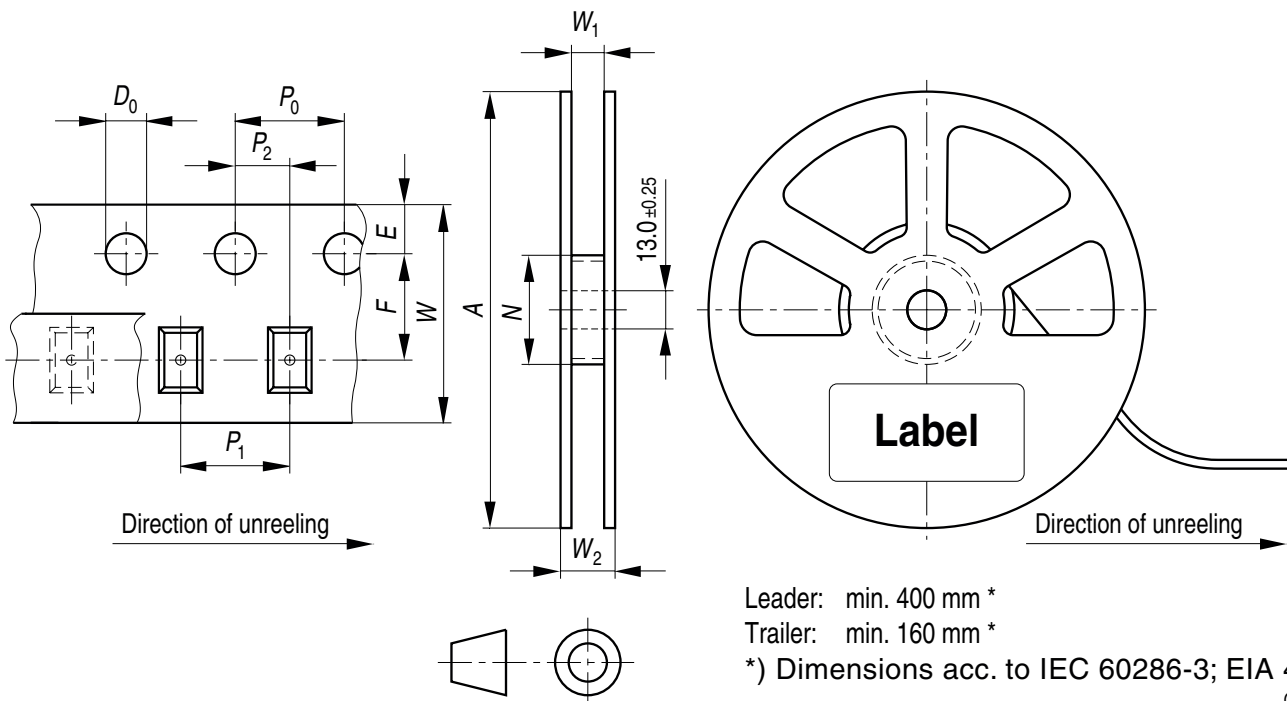

Tape dimensions [mm]

W	P ₀	P ₁	P ₂	D ₀	E	F
12 + 0.3 / - 0.1	4 ± 0.1	4 ± 0.1 or 8 ± 0.1	2 ± 0.05	1.5 ± 0.1	1.75 ± 0.1	5.5 ± 0.05

Reel dimensions [mm]

A	W	N _{min}	W ₁	W _{2max}
330	12	60	12.4 + 2	18.4

Barcode-Product-Label (BPL)

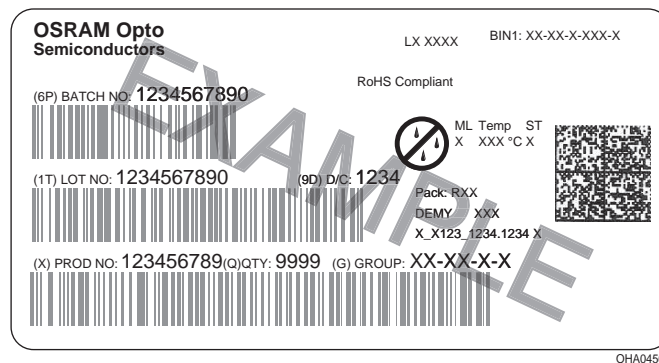

Dry Packing Process and Materials



Note:

Moisture-sensitive product is packed in a dry bag containing desiccant and a humidity card. Regarding dry pack you will find further information in the internet. Here you will also find the normative references like JEDEC.

Transportation Packing and Materials

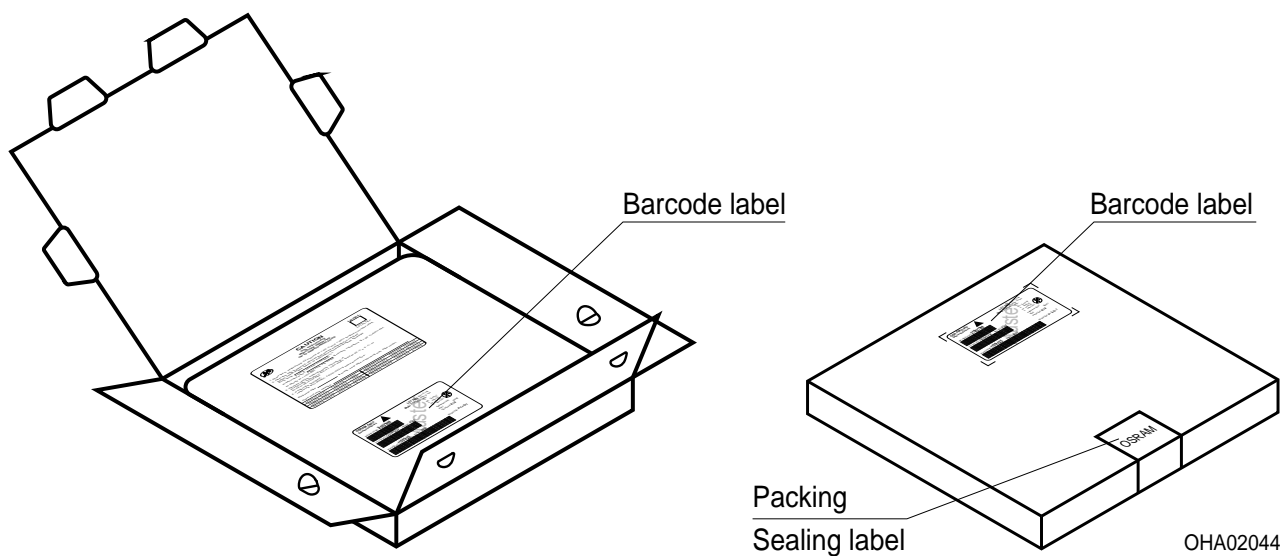

Dimensions of transportation box in mm

Width	Length	Height
349 ± 5	349 ± 5	33 ± 5

Disclaimer

Language english will prevail in case of any discrepancies or deviations between the two language wordings.

Attention please!

The information describes the type of component and shall not be considered as assured characteristics.

Terms of delivery and rights to change design reserved. Due to technical requirements components may contain dangerous substances.

For information on the types in question please contact our Sales Organization.

If printed or downloaded, please find the latest version in the Internet.

Packing

Please use the recycling operators known to you. We can also help you – get in touch with your nearest sales office.

By agreement we will take packing material back, if it is sorted. You must bear the costs of transport. For packing material that is returned to us unsorted or which we are not obliged to accept, we shall have to invoice you for any costs incurred.

Components used in life-support devices or systems must be expressly authorized for such purpose!

Critical components* may only be used in life-support devices** or systems with the express written approval of OSRAM OS.

*) A critical component is a component used in a life-support device or system whose failure can reasonably be expected to cause the failure of that life-support device or system, or to affect its safety or the effectiveness of that device or system.

**) Life support devices or systems are intended (a) to be implanted in the human body, or (b) to support and/or maintain and sustain human life. If they fail, it is reasonable to assume that the health and the life of the user may be endangered.

Glossary

- ¹⁾ **Typical Values:** Due to the special conditions of the manufacturing processes of LED, the typical data or calculated correlations of technical parameters can only reflect statistical figures. These do not necessarily correspond to the actual parameters of each single product, which could differ from the typical data and calculated correlations or the typical characteristic line. If requested, e.g. because of technical improvements, these typ. data will be changed without any further notice.

Published by OSRAM Opto Semiconductors GmbH
Leibnizstraße 4, D-93055 Regensburg
www.osram-os.com © All Rights Reserved.

EU RoHS and China RoHS compliant product



此产品符合欧盟 RoHS 指令的要求；
按照中国的相关法规和标准，不含有毒有害物质或元素。