

## N-channel Enhanced mode TO-220F/TO-220SF/TO-251/ TO-252/TO-220 MOSFET

### Features

- High ruggedness
- Low  $R_{DS(ON)}$  (Typ 0.5Ω) @  $V_{GS}=10V$
- Low Gate Charge (Typ 21nC)
- Improved dv/dt Capability
- 100% Avalanche Tested
- Application: Charge, LED, PC Power

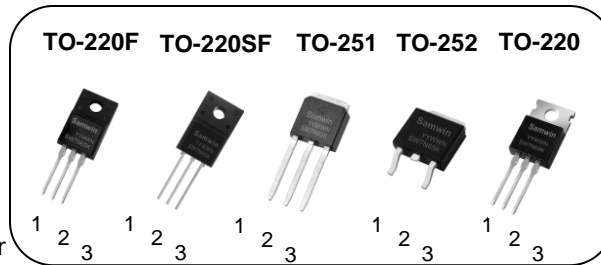

1. Gate 2. Drain 3. Source

$BV_{DSS}$  : 650V

$I_D$  : 7A

$R_{DS(ON)}$  : 0.5 Ω

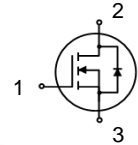

### General Description

This power MOSFET is produced with advanced technology of SAMWIN.

This technology enable the power MOSFET to have better characteristics, including fast switching time, low on resistance, low gate charge and especially excellent avalanche characteristics.



### Order Codes

Item	Sales Type	Marking	Package	Packaging
1	SW F 7N65K	SW7N65K	TO-220F	TUBE
2	SW MN 7N65K	SW7N65K	TO-220SF	TUBE
3	SW I 7N65K	SW7N65K	TO-251	TUBE
4	SWD 7N65K	SW7N65K	TO-252	REEL
5	SWP 7N65K	SW7N65K	TO-220	TUBE

### Absolute maximum ratings

Symbol	Parameter	Value				Unit
		TO-220F/ TO-220SF	TO-251	TO-252	TO-220	
$V_{DSS}$	Drain to source voltage	650				V
$I_D$	Continuous drain current (@ $T_C=25^\circ C$ )	7*				A
	Continuous drain current (@ $T_C=100^\circ C$ )	4.4*				A
$I_{DM}$	Drain current pulsed (note 1)	28				A
$V_{GS}$	Gate to source voltage	$\pm 30$				V
$E_{AS}$	Single pulsed avalanche energy (note 2)	150				mJ
$E_{AR}$	Repetitive avalanche energy (note 1)	7.6				mJ
dv/dt	Peak diode recovery dv/dt (note 3)	5				V/ns
$P_D$	Total power dissipation (@ $T_C=25^\circ C$ )	22.4	152.6	148.8	161.7	W
	Derating factor above 25°C	0.18	1.22	1.19	1.29	W/°C
$T_{STG}, T_J$	Operating junction temperature & storage temperature	-55 ~ + 150				°C
$T_L$	Maximum lead temperature for soldering purpose, 1/8 from case for 5 seconds.	300				°C

\*. Drain current is limited by junction temperature.

### Thermal characteristics

Symbol	Parameter	Value				Unit
		TO-220F/ TO-220SF	TO-251	TO-252	TO-220	
$R_{thjc}$	Thermal resistance, Junction to case	5.57	0.82	0.84	0.77	°C/W
$R_{thja}$	Thermal resistance, Junction to ambient	49.1	81.9		56	°C/W

Electrical characteristic (  $T_C = 25^\circ\text{C}$  unless otherwise specified )

Symbol	Parameter	Test conditions	Min.	Typ.	Max.	Unit
<b>Off characteristics</b>						
$BV_{DSS}$	Drain to source breakdown voltage	$V_{GS}=0V, I_D=250\mu A$	650			V
$\Delta BV_{DSS} / \Delta T_J$	Breakdown voltage temperature coefficient	$I_D=250\mu A$ , referenced to $25^\circ\text{C}$		0.4		$V/^\circ\text{C}$
$I_{DSS}$	Drain to source leakage current	$V_{DS}=650V, V_{GS}=0V$			1	$\mu A$
		$V_{DS}=520V, T_C=125^\circ\text{C}$			50	$\mu A$
$I_{GSS}$	Gate to source leakage current, forward	$V_{GS}=30V, V_{DS}=0V$			100	nA
	Gate to source leakage current, reverse	$V_{GS}=-30V, V_{DS}=0V$			-100	nA
<b>On characteristics</b>						
$V_{GS(TH)}$	Gate threshold voltage	$V_{DS}=V_{GS}, I_D=250\mu A$	2.5		4.0	V
$R_{DS(ON)}$	Drain to source on state resistance	$V_{GS}=10V, I_D=3.5A$		0.5	0.6	$\Omega$
$G_{fs}$	Forward transconductance	$V_{DS}=30V, I_D=3.5A$		4.8		S
<b>Dynamic characteristics</b>						
$C_{iss}$	Input capacitance	$V_{GS}=0V, V_{DS}=200V, f=1\text{MHz}$		638		pF
$C_{oss}$	Output capacitance			22		
$C_{riss}$	Reverse transfer capacitance			2.5		
$t_{d(on)}$	Turn on delay time	$V_{DS}=325V, I_D=7A, V_{GS}=10V, R_G=25\Omega$ (note 4,5)		11		ns
$t_r$	Rising time			29		
$t_{d(off)}$	Turn off delay time			48		
$t_f$	Fall time			28		
$Q_g$	Total gate charge	$V_{DS}=520V, V_{GS}=10V, I_D=7A$ (note 4,5)		21		nC
$Q_{gs}$	Gate-source charge			5		
$Q_{gd}$	Gate-drain charge			10		

### Source to drain diode ratings characteristics

Symbol	Parameter	Test conditions	Min.	Typ.	Max.	Unit
$I_S$	Continuous source current	Integral reverse p-n Junction diode in the MOSFET			7	A
$I_{SM}$	Pulsed source current				28	A
$V_{SD}$	Diode forward voltage drop.	$I_S=7A, V_{GS}=0V$			1.4	V
$t_{rr}$	Reverse recovery time	$I_S=7A, V_{GS}=0V, di_f/dt=100A/\mu s$		220		ns
$Q_{rr}$	Reverse recovery charge				2.4	$\mu C$

※. Notes

1. Repetitive rating : pulse width limited by junction temperature.
2.  $L=33\text{mH}, I_{AS}=3A, V_{DD}=50V, R_G=25\Omega$ , Starting  $T_J=25^\circ\text{C}$
3.  $I_{SD} \leq 7A, di/dt = 100A/\mu s, V_{DD} \leq BV_{DSS}$ , Starting  $T_J=25^\circ\text{C}$
4. Pulse Test : Pulse Width  $\leq 300\mu s$ , duty cycle  $\leq 2\%$ .
5. Essentially independent of operating temperature.

**Fig. 1. On-state characteristics**

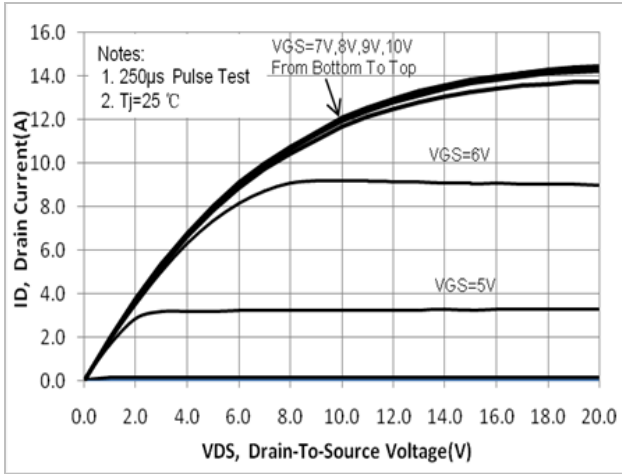

**Fig. 2. On-resistance variation vs. drain current and gate voltage**

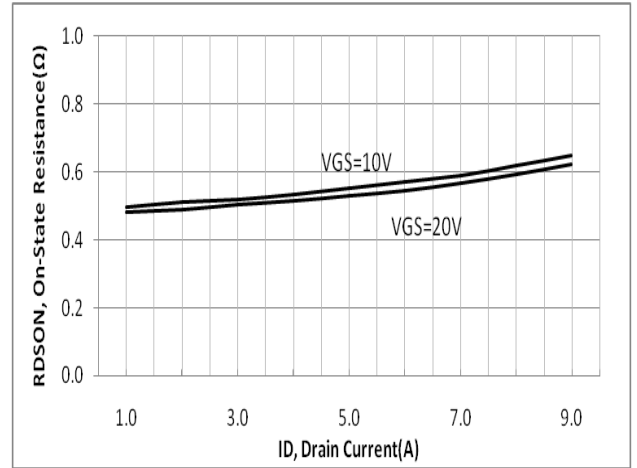

**Fig. 3. Gate charge characteristics**

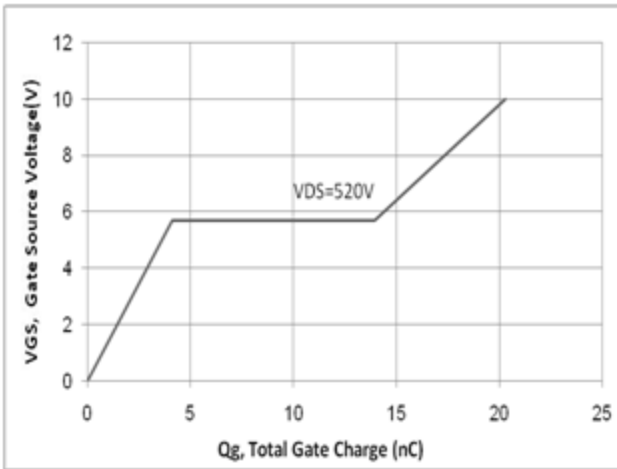

**Fig. 4. On state current vs. diode forward voltage**

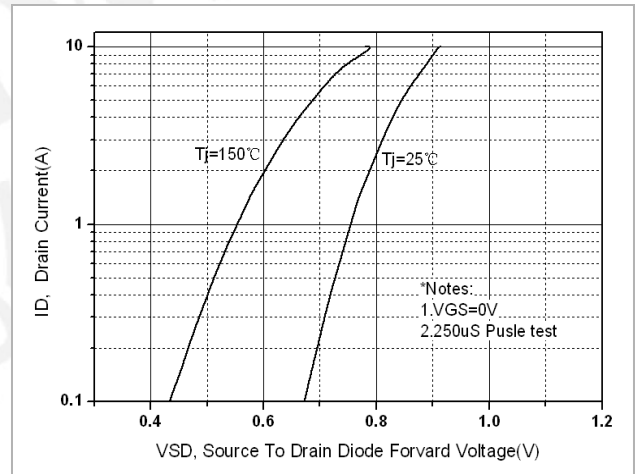

**Fig 5. Breakdown Voltage Variation vs. Junction Temperature**

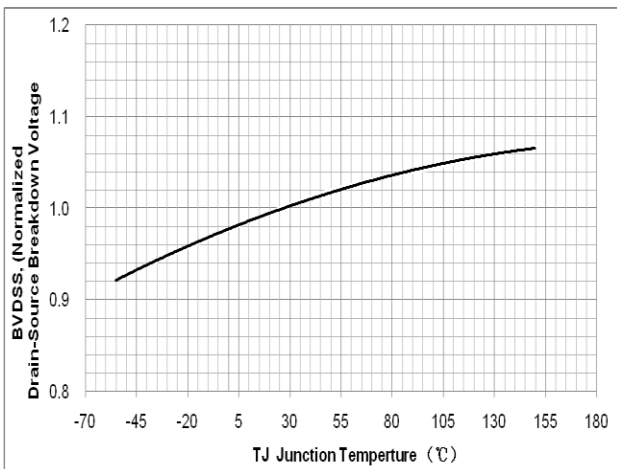

**Fig. 6. On resistance variation vs. junction temperature**

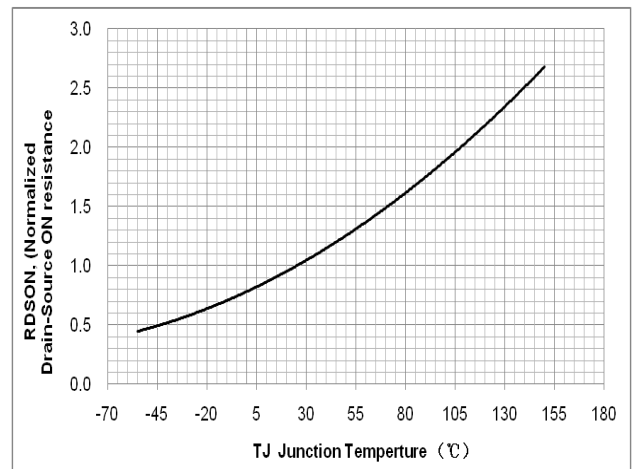

**Fig. 7. Maximum safe operating area (TO-220F/TO-220SF)**

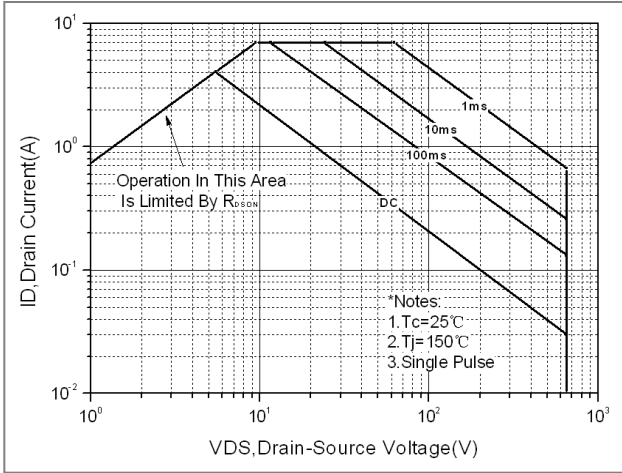

**Fig. 8. Maximum safe operating area(TO-251)**

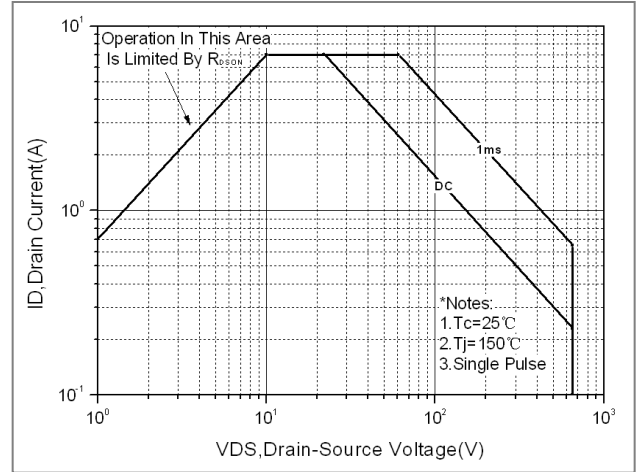

**Fig. 9. Maximum safe operating area(TO-252)**

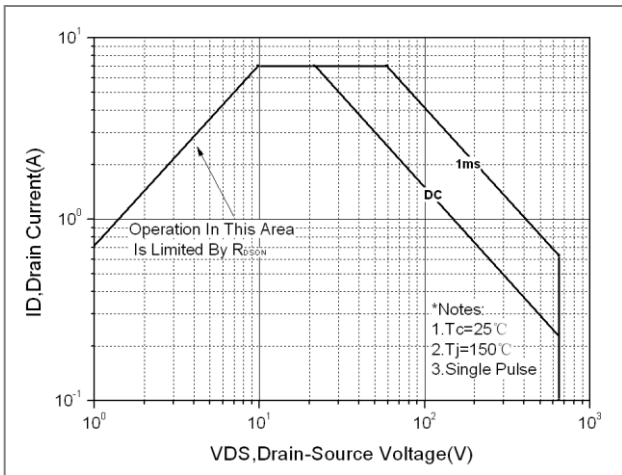

**Fig. 10. Maximum safe operating area(TO-220)**

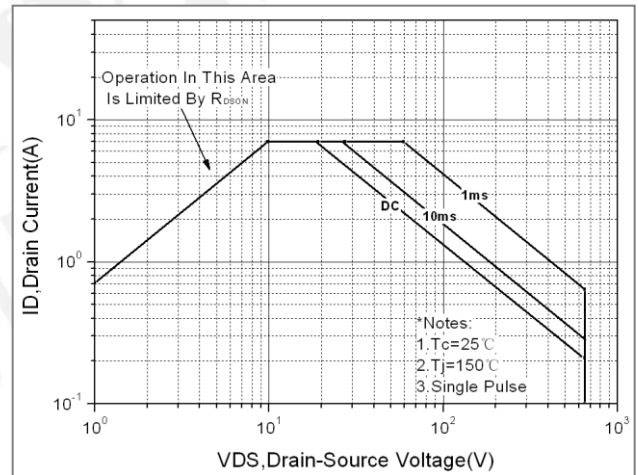

**Fig. 11. Capacitance Characteristics**

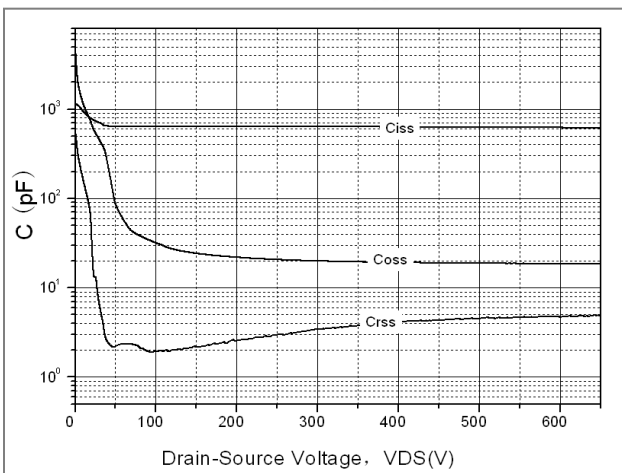

Fig. 12. Transient thermal response curve (TO-220F/TO-220SF)

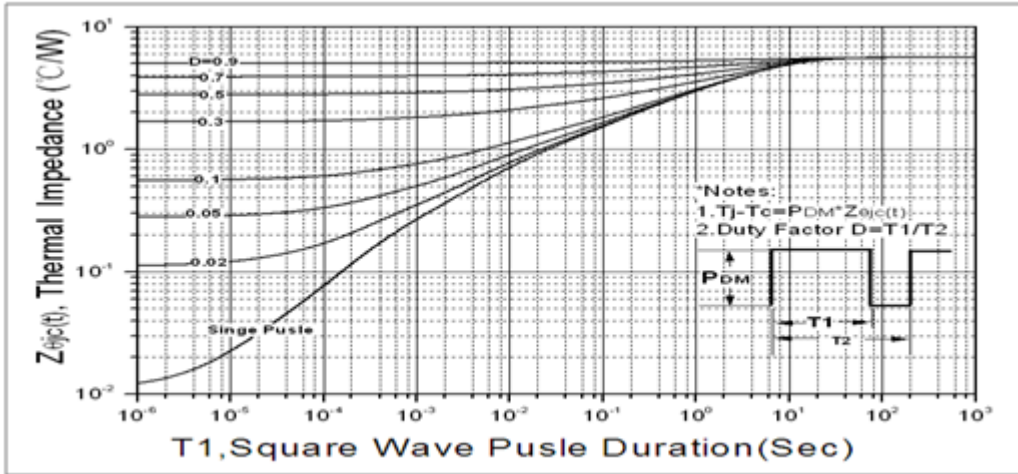

Fig. 13. Transient thermal response curve(TO-251)

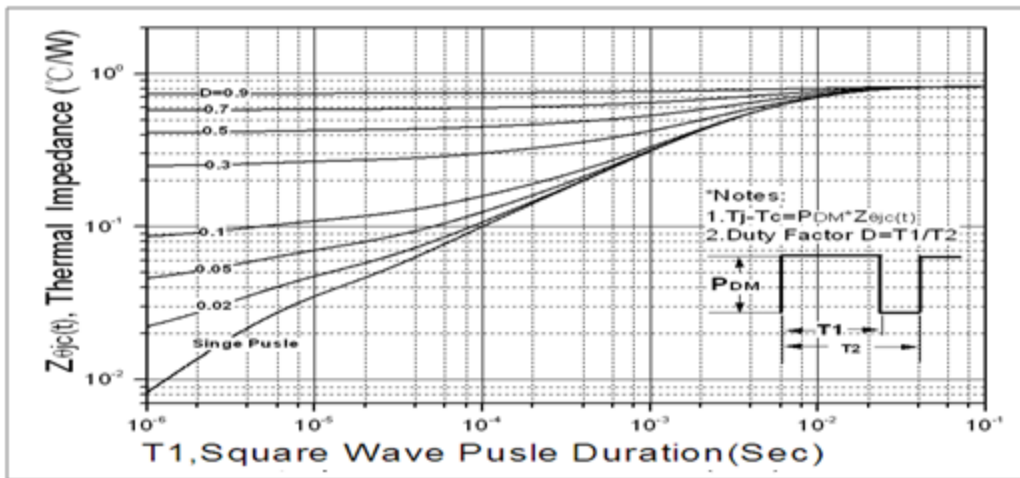

Fig. 14. Transient thermal response curve(TO-252)

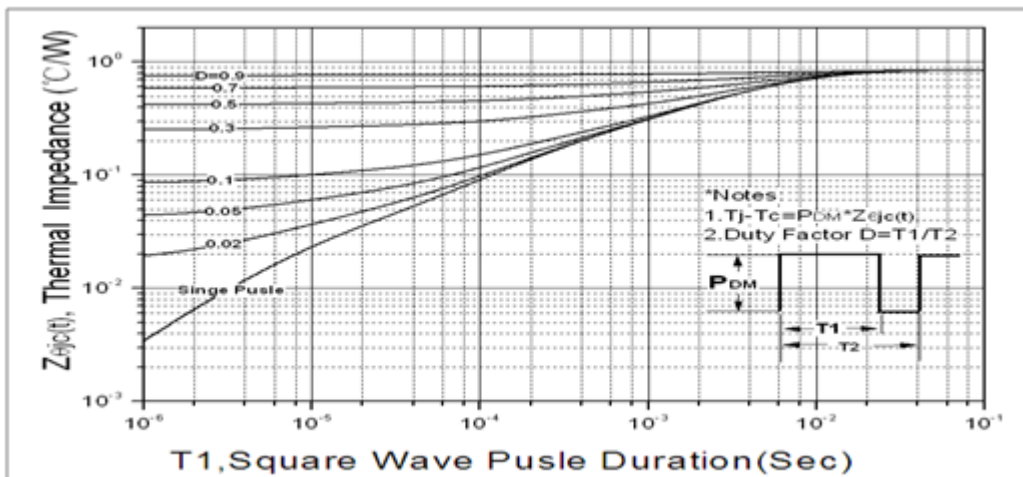

Fig. 15. Transient thermal response curve(TO-220)

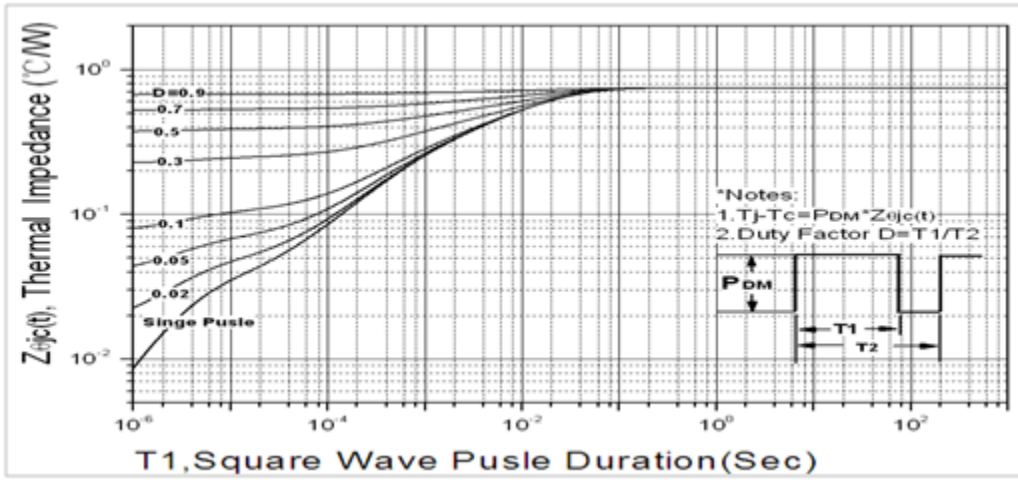

Fig. 16. Gate charge test circuit & waveform

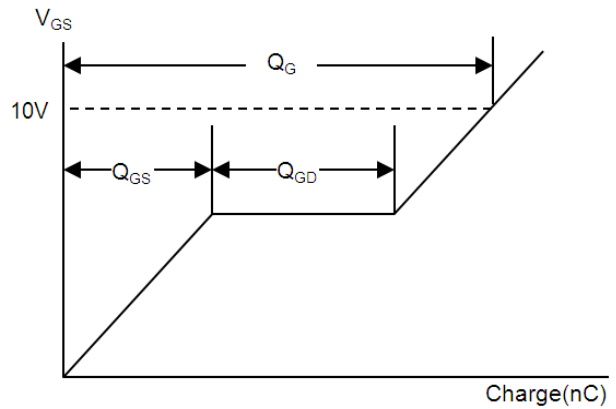
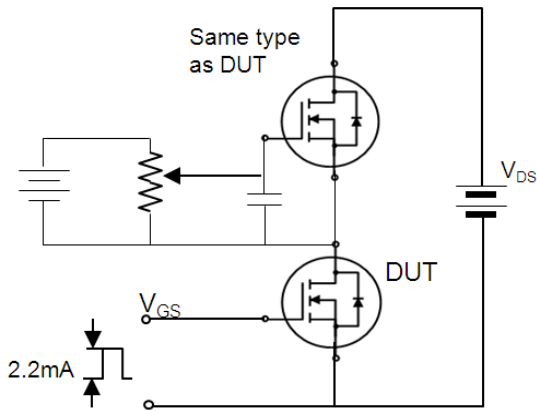

Fig. 17. Switching time test circuit & waveform

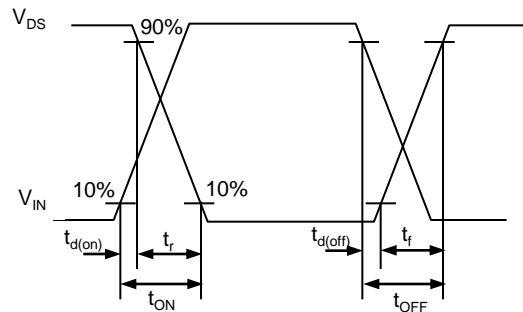
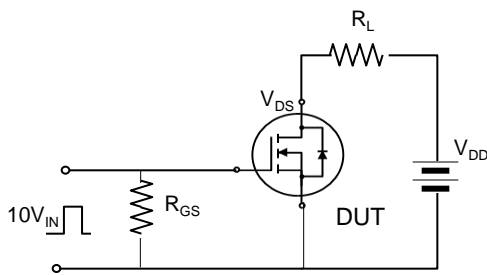

Fig. 18. Unclamped Inductive switching test circuit & waveform

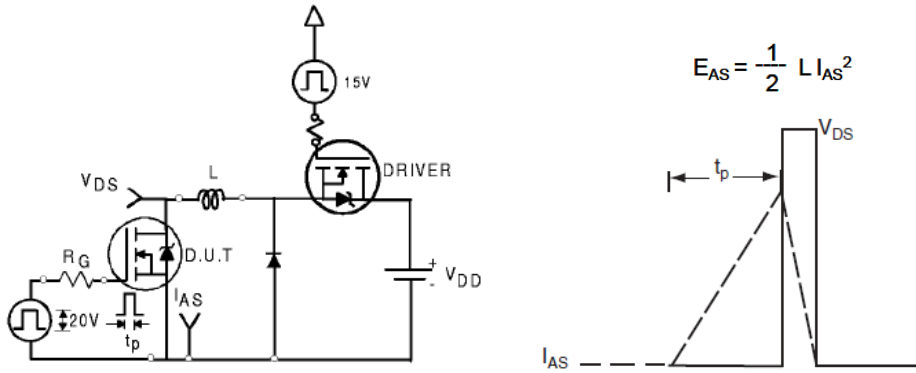
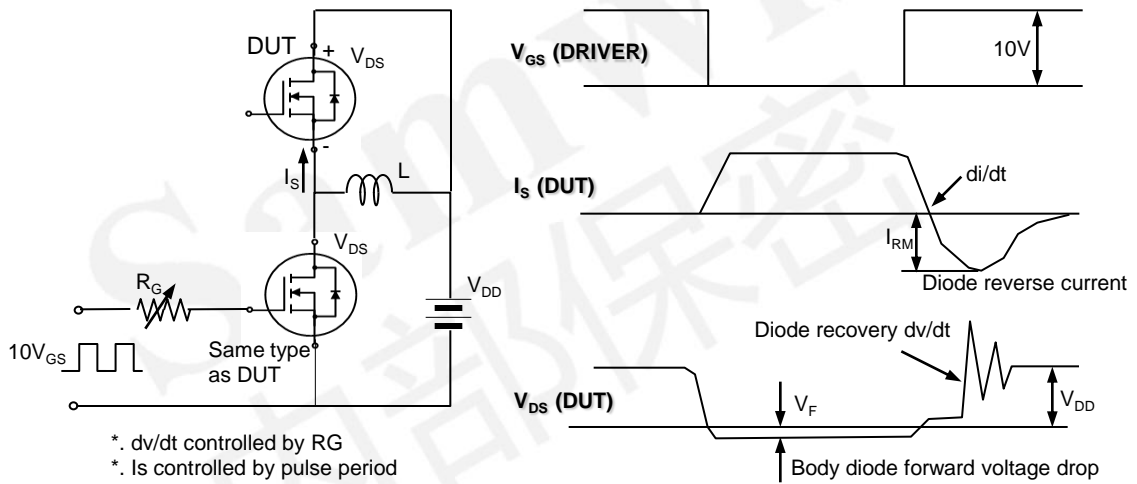

Fig. 19. Peak diode recovery dv/dt test circuit & waveform



### DISCLAIMER

\* All the data & curve in this document was tested in XI' AN SEMIPOWER TESTING & APPLICATION CENTE R.

\* This product has passed the PCT,TC,HTRB,HTGB,HAST,PC and Solderdunk reliability test.

\* Qualification standards can also be found on the Web site (<http://www.semipower.com.cn>)

\* Suggestions for improvement are appreciated, Please send your suggestions to [samwin@samwinsemi.com](mailto:samwin@samwinsemi.com)