

## Features

- Bidirectional TVS 3.3 V
- Low capacitance - 13 pF
- ESD protection 15 kV
- 0402 DFN package
- RoHS compliant\*

## Applications

- Computers and peripherals
- Communication systems
- Audio & video equipment
- Portable instrumentation
- Handheld portable devices

# CDDFN2-T3.3B - Surface Mount TVS Diode

## General Information

The Bourns® Model CDDFN2-T3.3B low capacitance device provides ESD, EFT and surge protection for external ports of electronic devices such as cellular phones, handheld electronics and other portable electronic devices.

The device measures 1.0 mm x 0.60 mm x 0.55 mm and is available in a DFN-2 package intended to be mounted directly onto an FR4 printed circuit board. The device will fit a 0402 footprint.

The device is designed to meet IEC 61000-4-2 (ESD), IEC 61000-4-4 (EFT) and IEC61000-4-5 (Surge) protection requirements.

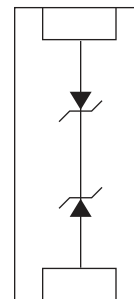

## Maximum Ratings (@ T<sub>A</sub> = 25 °C Unless Otherwise Noted)

Parameter	Symbol	Value	Unit
Storage Temperature	T <sub>STG</sub>	-55 to +150	°C
Operating Temperature	T <sub>OPR</sub>	-55 to +85	°C
ESD Protection per IEC 61000-4-2	Contact Discharge	ESD	15
	Air Discharge	ESD	15
EFT Protection per IEC 61000-4-4 (5/50 ns)	EFT	50	A
Peak Pulse Current per IEC 61000-4-5 (8/20 μs)	I <sub>pp</sub>	5	A

## Electrical Characteristics (@ T<sub>A</sub> = 25 °C Unless Otherwise Noted)

Parameter	Symbol	Min.	Typ.	Max.	Unit
Working Peak Voltage	V <sub>WM</sub>	-3.3		3.3	V
Breakdown Voltage @ 1 mA	V <sub>BR</sub>	4		6.5	V
Leakage Current @ 3.3 V	I <sub>L</sub>		0.1	1.0	μA
Capacitance @ 0 V, 1 MHz	C <sub>J</sub>		13.5	16.5	pF
Clamping Voltage @ I <sub>pp</sub> = 5 A, 8/20 μs	V <sub>C</sub>		6.5	8	V

**BOURNS®**

**Asia-Pacific:** Tel: +886-2 2562-4117 • Fax: +886-2 2562-4116

**EMEA:** Tel: +36 88 520 390 • Fax: +36 88 520 211

**The Americas:** Tel: +1-951 781-5500 • Fax: +1-951 781-5700

[www.bourns.com](http://www.bourns.com)

\*RoHS Directive 2002/95/EC Jan. 27, 2003 including annex and RoHS Recast 2011/65/EU June 8, 2011.

Specifications are subject to change without notice.

The device characteristics and parameters in this data sheet can and do vary in different applications and actual device performance may vary over time. Users should verify actual device performance in their specific applications.

# CDDFN2-T3.3B - Surface Mount TVS Diode



## Product Dimensions

This is a molded DFN-2 package weighing approximately 0.9 mg.

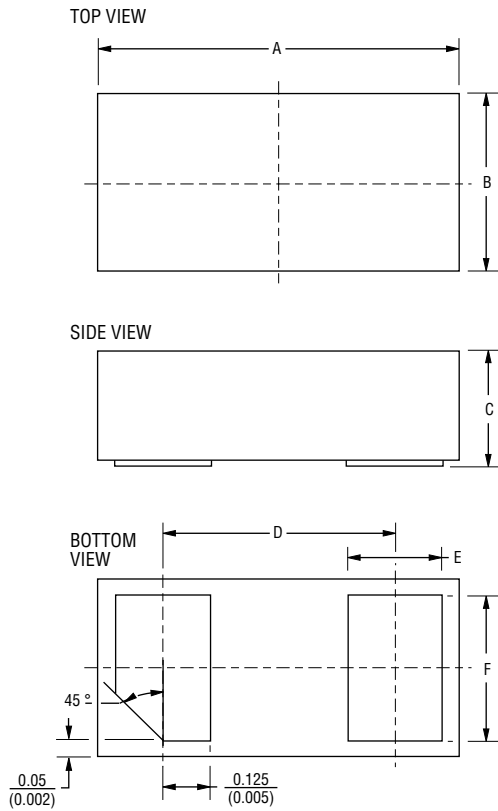

Symbol	Dimensions		
	Min.	Nom.	Max.
A	$\frac{0.95}{(0.037)}$	$\frac{1.00}{(0.039)}$	$\frac{1.05}{(0.041)}$
B	$\frac{0.55}{(0.022)}$	$\frac{0.60}{(0.024)}$	$\frac{0.65}{(0.026)}$
C	$\frac{0.41}{(0.016)}$	$\frac{0.45}{(0.018)}$	$\frac{0.50}{(0.020)}$
D	$\frac{0.65}{(0.026)}$		
E	$\frac{0.20}{(0.008)}$	$\frac{0.25}{(0.010)}$	$\frac{0.30}{(0.012)}$
F	$\frac{0.45}{(0.018)}$	$\frac{0.50}{(0.020)}$	$\frac{0.55}{(0.022)}$

DIMENSIONS:  $\frac{\text{MM}}{\text{(INCHES)}}$

## Recommended PCB Footprint

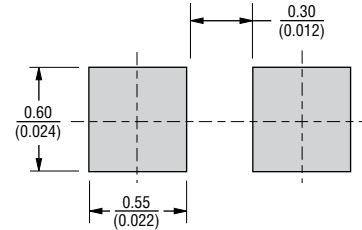

## Typical Part Marking

CDDFN2-T3.3B ..... Y

## How to Order

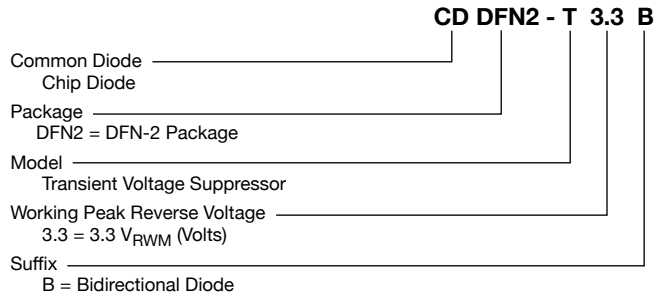

## Block Diagram

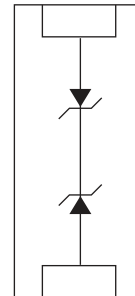

Specifications are subject to change without notice. The device characteristics and parameters in this data sheet can and do vary in different applications and actual device performance may vary over time. Users should verify actual device performance in their specific applications.

# CDDFN2-T3.3B - Surface Mount TVS Diode

**BOURNS®**

## Performance Graphs

### Pulse Waveform

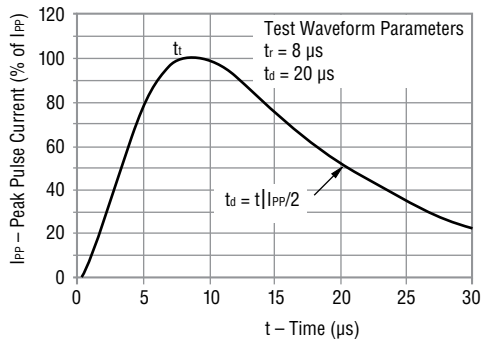

### TLP I-V Plot

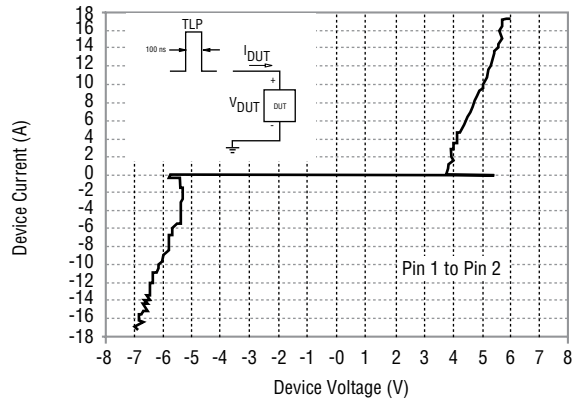

### Typical Capacitance Variation of $C_{IN}$ vs $V_{IN}$

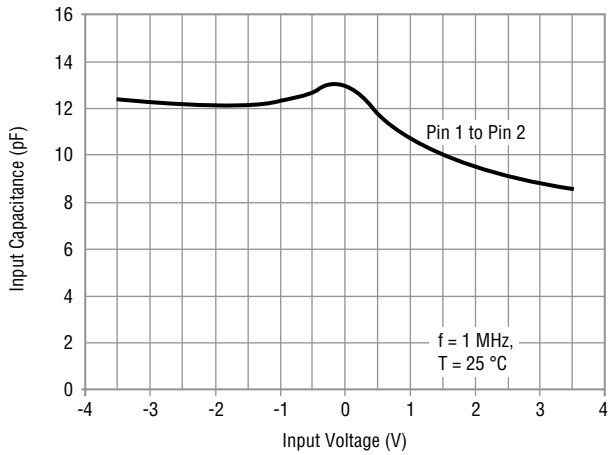

Specifications are subject to change without notice.  
 The device characteristics and parameters in this data sheet can and do vary in different applications and actual device performance may vary over time.  
 Users should verify actual device performance in their specific applications.

# CDDFN2-T3.3B - Surface Mount TVS Diode

**BOURNS®**

## Packaging Information

The surface mount product is packaged in an 8 mm x 4 mm tape and reel format per EIA-481 standard.

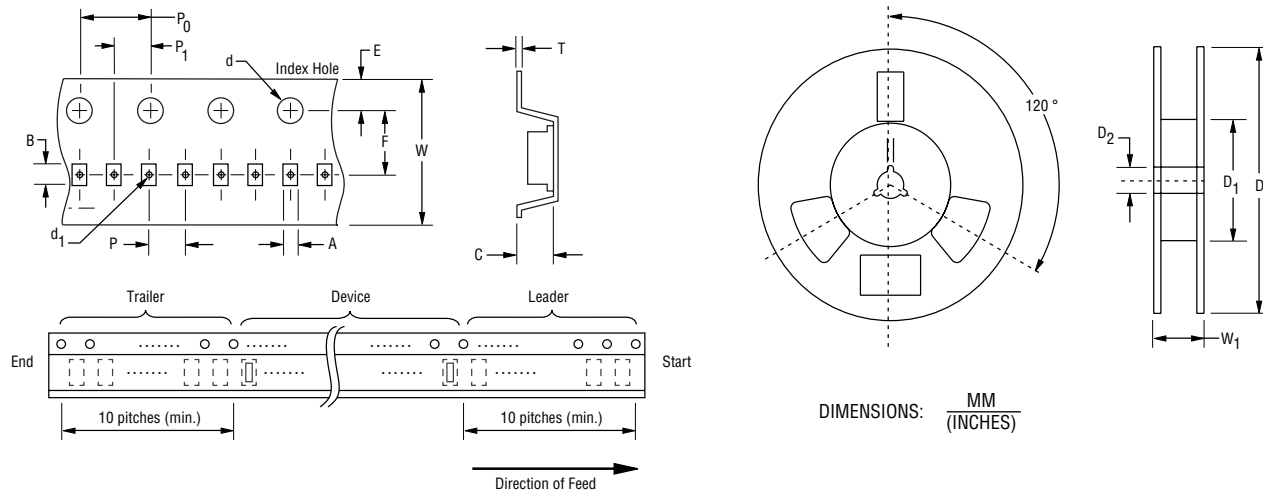

Item	Symbol	DFN-2
Carrier Width	A	$\frac{0.70 \pm 0.05}{(0.028 \pm 0.002)}$
Carrier Length	B	$\frac{1.15 \pm 0.05}{(0.045 \pm 0.002)}$
Carrier Depth	C	$\frac{0.47 \pm 0.05}{(0.019 \pm 0.002)}$
Sprocket Hole	d	$\frac{1.55 \pm 0.05}{(0.061 \pm 0.002)}$
Reel Outside Diameter	D	$\frac{179.0 \pm 1.00}{(7.05 \pm 0.04)}$
Punch Hole	d <sub>1</sub>	$\frac{0.4 \pm 0.05}{0.016 \pm 0.002}$
Reel Inner Diameter	D <sub>1</sub>	$\frac{60.0 \pm 0.50}{2.362 \pm 0.02}$
Feed Hole Diameter	D <sub>2</sub>	$\frac{13.0 \pm 0.20}{(0.512 \pm 0.008)}$
Sprocket Hole Position	E	$\frac{1.75 \pm 0.10}{(0.069 \pm 0.004)}$
Punch Hole Position	F	$\frac{3.50 \pm 0.05}{(0.138 \pm 0.002)}$
Punch Hole Pitch	P	$\frac{2.00 \pm 0.05}{(0.079 \pm 0.002)}$
Sprocket Hole Pitch	P <sub>0</sub>	$\frac{4.00 \pm 0.10}{(0.157 \pm 0.004)}$
Embossment Center	P <sub>1</sub>	$\frac{2.00 \pm 0.05}{(0.079 \pm 0.002)}$
Overall Tape Thickness	T	$\frac{0.20 \pm 0.05}{(0.008 \pm 0.002)}$
Tape Width	W	$\frac{8.00 \pm 0.10}{(0.315 \pm 0.004)}$
Reel Width	W <sub>1</sub>	$\frac{14.4}{(0.567)}$ MAX.
Quantity per Reel	--	12,000

REV. 02/16

Specifications are subject to change without notice.  
The device characteristics and parameters in this data sheet can  
and do vary in different applications and actual device performance may vary over time.  
Users should verify actual device performance in their specific applications.