

High Voltage, Isolated MOSFET Driver

Features

- ▶ $\pm 400V$ input to output isolation
- ▶ Low input logic current, $500\mu A$ max
- ▶ No external voltage supply required
- ▶ Floating isolated output drivers
- ▶ 5.0V logic compatible

Applications

- ▶ Telecommunications
- ▶ Modems
- ▶ Solid state relays
- ▶ High side switches
- ▶ High end audio switches
- ▶ Avionics
- ▶ ATE

General Description

The Supertex HT0740 is a single channel, high voltage, low input current, isolated driver utilizing Supertex's proprietary HVCMOS[®] technology. It is designed to drive discrete MOSFETs, configured as high side switches, up to 400V. The HT0740 generates an independent DC isolated voltage across the pair of outputs when the logic input is at a logic high. The HT0740 does not require any external power supplies. The internal supply voltage is supplied from the logic input when it is in the high state.

Block Diagram

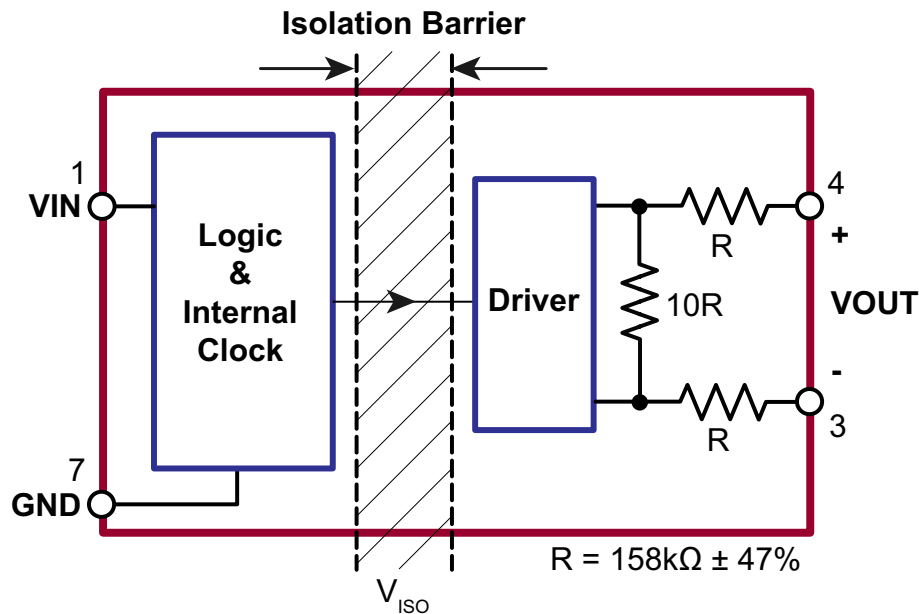

Ordering Information

Part Number	Package Option	Packing
HT0740LG-G	8-Lead SOIC (Narrow Body)	2500/Reel

-G denotes a lead (Pb)-free / RoHS compliant package

Pin Configuration

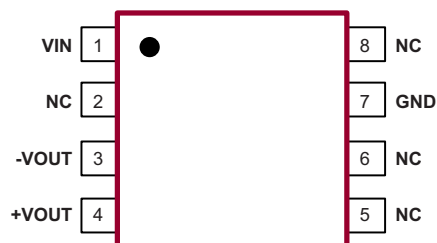

8-Lead SOIC (Narrow Body)
(top view)

Absolute Maximum Ratings

Parameter	Value
Input to output isolation voltage, V_{ISO}	$\pm 400V$
Logic input voltage, V_{IN}	-0.5 to +7.0V
Operating temperature	-40°C to +85°C
Storage temperature	-55°C to +150°C

Absolute Maximum Ratings are those values beyond which damage to the device may occur. Functional operation under these conditions is not implied. Continuous operation of the device at the absolute rating level may affect device reliability. All voltages are referenced to device ground.

Product Marking



YY = Year Sealed
 WW = Week Sealed
 L = Lot Number
 _____ = "Green" Packaging

Package may or may not include the following marks: Si or

8-Lead SOIC (Narrow Body)

Typical Thermal Resistance

Package	θ_{ja}
8-Lead SOIC (Narrow Body)	101°C/W

Recommended Operating Conditions

Sym	Parameter	Min	Typ	Max	Units	Conditions
V_{IH}	Logic input high voltage	3.15	-	5.5	V	---
V_{IL}	Logic input low voltage	0	-	0.5	V	---
T_A	Operating temperature	-40	-	+85	°C	---

DC Electrical Characteristics

I_H	Logic high input current	-	-	500	μA	$V_{IN} = 5.0V$
I_L	Logic low input current (quiescent)	-	-	10	μA	$V_{IN} = 0.5V$
V_{OUT}	Output voltage across output terminals	4.5	-	-	V	$V_{IN} = 3.15V$, no load
		8.5	-	-	V	$V_{IN} = 4.50V$, no load
V_{IN}	Input voltage for zero output	-	-	0.8	V	No load
V_{ISO}	Input to output isolation voltage	± 400	-	-	V	---

AC Electrical Characteristics

$t_{d(ON)}$	Turn-on delay time	-	-	50	μs	See timing diagram and test circuit $C_L = 600pF$, $T_A = 25^\circ C$
t_r	Rise time	-	-	650	μs	
$t_{d(OFF)}$	Turn-off delay time	-	-	150	μs	
t_f	Fall time	-	-	3.0	ms	

Timing Diagram

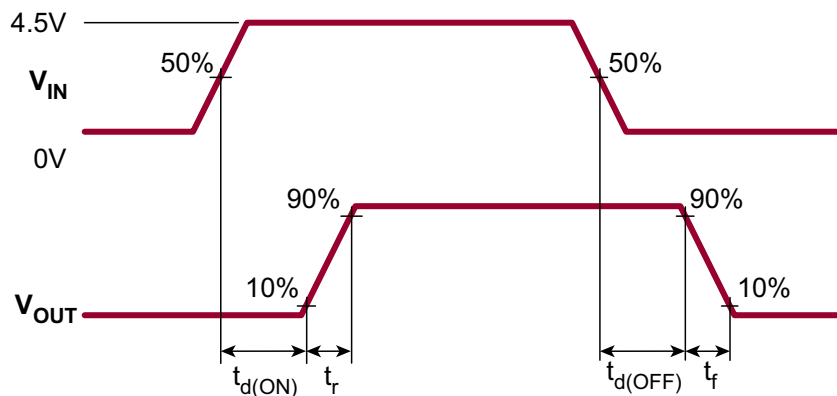

Test Circuit

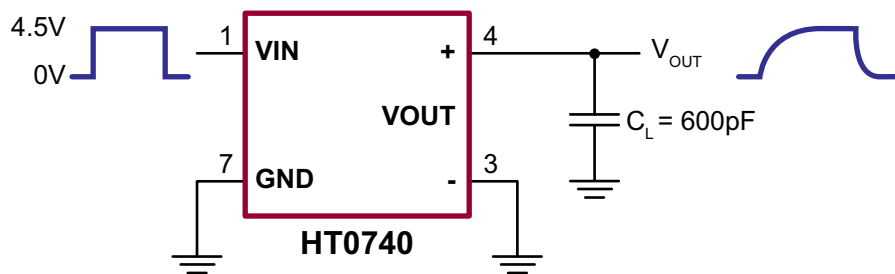

8-Lead SOIC (Narrow Body) Package Outline (LG)

4.90x3.90mm body, 1.75mm height (max), 1.27mm pitch

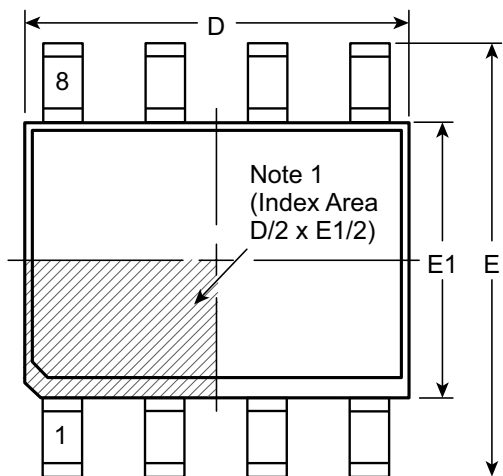

Top View

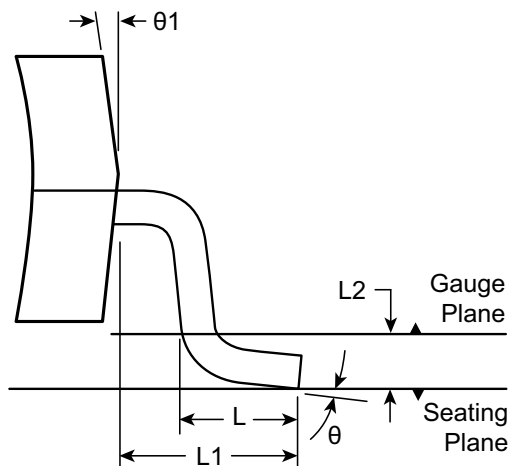

View B

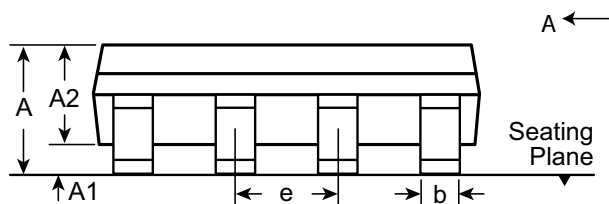

Side View

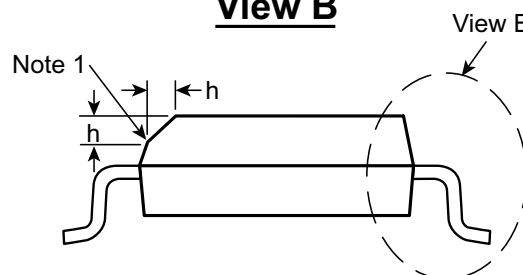

View A-A

Note:
 1. This chamfer feature is optional. A Pin 1 identifier must be located in the index area indicated. The Pin 1 identifier can be: a molded mark/identifier; an embedded metal marker; or a printed indicator.

Symbol	A	A1	A2	b	D	E	E1	e	h	L	L1	L2	θ	θ1	
Dimension (mm)	MIN	1.35*	0.10	1.25	0.31	4.80*	5.80*	3.80*	1.27 BSC	0.25	0.40	1.04 REF	0.25 BSC	0°	5°
	NOM	-	-	-	-	4.90	6.00	3.90		-	-			-	-
	MAX	1.75	0.25	1.65*	0.51	5.00*	6.20*	4.00*		0.50	1.27			8°	15°

JEDEC Registration MS-012, Variation AA, Issue E, Sept. 2005.

* This dimension is not specified in the JEDEC drawing.

Drawings are not to scale.

Supertex Doc. #: DSPD-8SOLGTG, Version I041309.

(The package drawing(s) in this data sheet may not reflect the most current specifications. For the latest package outline information go to <http://www.supertex.com/packaging.html>.)

Supertex inc. does not recommend the use of its products in life support applications, and will not knowingly sell them for use in such applications unless it receives an adequate "product liability indemnification insurance agreement." **Supertex inc.** does not assume responsibility for use of devices described, and limits its liability to the replacement of the devices determined defective due to workmanship. No responsibility is assumed for possible omissions and inaccuracies. Circuitry and specifications are subject to change without notice. For the latest product specifications refer to the **Supertex inc.** (website: <http://www.supertex.com>)