



# THTL-1AASB0424MZ

THTL

TEMPERATURE SENSORS

**SICK**  
Sensor Intelligence.



Illustration may differ



### Ordering information

Type	Part no.
THTL-1AASB0424MZ	6047647

Other models and accessories → [www.sick.com/THTL](http://www.sick.com/THTL)

### Detailed technical data

#### Features

<b>Measuring range</b>	-50 °C +150 °C
<b>Sensor element</b>	Pt100, Pt1000 (for 4 mA ... 20 mA version)
<b>Analog signal output and ohmic load R<sub>A</sub></b>	4 mA ... 20 mA, 2-wire (R <sub>A</sub> ≤ (L <sup>+</sup> - 10 V) / 0.023 A [Ohm])

#### Performance

<b>Accuracy of sensor element</b>	Class A according to IEC 60751 <sup>1)</sup>
<b>Transmitter accuracy</b>	± 0,25 K
<b>Transmitter linearity</b>	≤ ± 0.1 % of span
<b>Response time</b>	t <sub>50</sub> ≤ 3,2 s t <sub>90</sub> ≤ 9,1 s <sup>2)</sup>

<sup>1)</sup> Class B (measuring range -50 °C ... -30 °C).

<sup>2)</sup> Depending on sensor configuration, according to IEC 60751.

#### Mechanics/electronics

<b>Process connection</b>	Straight pipe (DIN EN ISO 1127 and DIN 11866), row B, for welding
<b>Nominal width</b>	DN 42.4
<b>Wetted parts</b>	Stainless steel 1.4435 / 316L, R <sub>a</sub> ≤ 0.8 μm
<b>Pressure resistance</b>	Max. 25 bar at room temperature
<b>Housing material</b>	Stainless steel (CrNi)
<b>Electrical connection</b>	Round connector M12 x 1, 4-pin, IP 67 and IP 69 <sup>1)</sup>
<b>Supply voltage</b>	10 V DC ... 35 V DC
<b>Maximum current consumption</b>	Ca. 30 mA
<b>Electrical safety</b>	Protection class: III, dielectric strength: 500 V AC, Reverse polarity protection: L <sup>+</sup> to M
<b>Protection class III</b>	✓
<b>CE-conformity</b>	2004/108/EC, EN 61326-2-3
<b>RoHS certificate</b>	✓
<b>Initialization time</b>	Max. 4 s

<sup>1)</sup> IP enclosure rating as per IEC 60529. The enclosure rating classes specified only apply while the device is connected with male cable connectors of the corresponding enclosure rating.

## Ambient data

<b>Ambient temperature</b>	-40 °C ... +85 °C
<b>Storage and transport temperature</b>	-40 °C ... +85 °C
<b>Shock resistance</b>	50 g, 6ms (according to IEC 60068-2-27)
<b>Relative humidity</b>	100 % <sup>1)</sup>

<sup>1)</sup> , Condensation allowed.

## Classifications

<b>ECl@ss 5.0</b>	27200208
<b>ECl@ss 5.1.4</b>	27200208
<b>ECl@ss 6.0</b>	27200208
<b>ECl@ss 6.2</b>	27200208
<b>ECl@ss 7.0</b>	27200208
<b>ECl@ss 8.0</b>	27200208
<b>ECl@ss 8.1</b>	27200208
<b>ECl@ss 9.0</b>	27200208
<b>ETIM 5.0</b>	EC001446
<b>ETIM 6.0</b>	EC001446
<b>UNSPSC 16.0901</b>	41112211

## Dimensional drawing (Dimensions in mm (inch))

Process connection: Straight pipe

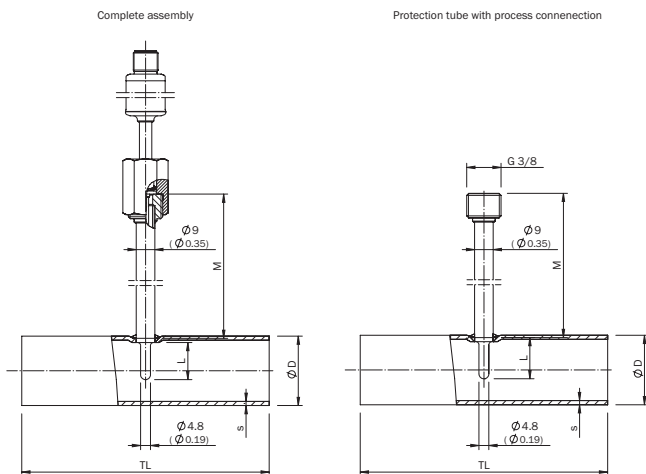

Design		Ø D	s	TL	L	M
<b>Straight pipe</b>	NW 17.2	17.2 (0.68)	1.6 (0.06)	68.0 (2.68)	9.0 (0.35)	48.0 (1.89)
	NW 21.3	21.3 (0.84)	1.6 (0.06)	72.0 (2.83)	11.0 (0.43)	46.0 (1.81)
	NW 26.9	26.9 (1.06)	1.6 (0.06)	110.0 (4.33)	11.0 (0.43)	46.0 (1.81)
	NW 42.4	42.4 (1.67)	2.0 (0.08)	130.0 (5.12)	18.0 (0.71)	39.0 (1.54)

## Application





## Connection type

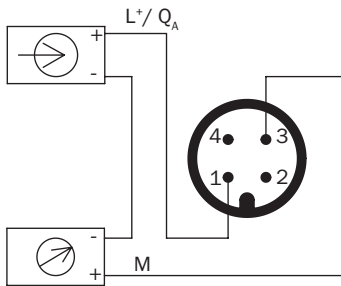







Plug M12 x 1, output signal 4 mA ... 20 mA



## Recommended accessories

Other models and accessories → [www.sick.com/THTL](http://www.sick.com/THTL)

	Brief description	Type	Part no.
<b>Plug connectors and cables</b>			
	Head A: female connector, M12, 4-pin, straight Head B: cable Cable: PVC, unshielded, 2 m	DOL-1204-G02M	6009382
	Head A: female connector, M12, 4-pin, straight Head B: cable Cable: drag chain use, PUR, halogen-free, unshielded, 2 m	DOL-1204-G02MC	6025900
	Head A: female connector, M12, 4-pin, straight Head B: cable Cable: PVC, unshielded, 5 m	DOL-1204-G05M	6009866
	Head A: female connector, M12, 4-pin, straight Head B: cable Cable: drag chain use, PUR, halogen-free, unshielded, 5 m	DOL-1204-G05MC	6025901
	Head A: female connector, M12, 4-pin, straight Head B: cable Cable: PVC, unshielded, 10 m	DOL-1204-G10M	6010543

	<b>Brief description</b>	<b>Type</b>	<b>Part no.</b>
	Head A: female connector, M12, 4-pin, straight Head B: cable Cable: drag chain use, PUR, halogen-free, unshielded, 10 m	DOL-1204-G10MC	6025902
	Head A: female connector, M12, 4-pin, straight Head B: cable Cable: PVC, unshielded, 15 m	DOL-1204-G15M	6010753
	Head A: female connector, M12, 4-pin, angled Head B: cable Cable: PVC, unshielded, 2 m	DOL-1204-W02M	6009383
	Head A: female connector, M12, 4-pin, angled Head B: cable Cable: drag chain use, PUR, halogen-free, unshielded, 2 m	DOL-1204-W02MC	6025903
	Head A: female connector, M12, 4-pin, angled Head B: cable Cable: PVC, unshielded, 5 m	DOL-1204-W05M	6009867
	Head A: female connector, M12, 4-pin, angled Head B: cable Cable: drag chain use, PUR, halogen-free, unshielded, 5 m	DOL-1204-W05MC	6025904
	Head A: female connector, M12, 4-pin, angled Head B: cable Cable: PVC, unshielded, 10 m	DOL-1204-W10M	6010541
	Head A: female connector, M12, 4-pin, angled Head B: cable Cable: drag chain use, PUR, halogen-free, unshielded, 10 m	DOL-1204-W10MC	6025905

## SICK AT A GLANCE

SICK is one of the leading manufacturers of intelligent sensors and sensor solutions for industrial applications. A unique range of products and services creates the perfect basis for controlling processes securely and efficiently, protecting individuals from accidents and preventing damage to the environment.

We have extensive experience in a wide range of industries and understand their processes and requirements. With intelligent sensors, we can deliver exactly what our customers need. In application centers in Europe, Asia and North America, system solutions are tested and optimized in accordance with customer specifications. All this makes us a reliable supplier and development partner.

Comprehensive services complete our offering: SICK LifeTime Services provide support throughout the machine life cycle and ensure safety and productivity.

For us, that is “Sensor Intelligence.”

## WORLDWIDE PRESENCE:

Contacts and other locations –[www.sick.com](http://www.sick.com)