

# APPROVAL SHEET

## 承認書

Customer 客戶名稱	
Part No. 產品型號	TVL-55736GD032JR-LW-G-AAN
Product type 產品內容	Mode: Transmissive and Normally white type 3.2" TFT LCD module
RoHS 綠色產品	<input type="checkbox"/> Non-compliance <input checked="" type="checkbox"/> Compliance
Remarks 備註欄	
<input checked="" type="checkbox"/> Preliminary Specification 暫行規格 <input type="checkbox"/> Final Specification 正式規格  Signature by Customer: 客戶確認簽章:	

Issued by QA	Checked by QA	Checked by PM	Approved By	
			QA	RD

## Specification of LCD Module

Product No.: TVL-55736GD032JR-LW-G-AAN

Issue date: 2013/02/21

KYOCERA DISPLAY CORPORATION  
5-7-18 Higashinippori Arakawa-ku Tokyo Japan

TEL: +81-03-5811-8772(Direct)  
FAX: +81-03-5811-8787

## **TABLE OF CONTENTS**

<b>1. GENERAL DESCRIPTION .....</b>	<b>5</b>
<b>2. FEATURES.....</b>	<b>5</b>
<b>3. MECHANICAL SPECIFICATION.....</b>	<b>5</b>
<b>4. MECHANICAL DIMENSION .....</b>	<b>6</b>
<b>5. MAXIMUM RATINGS.....</b>	<b>7</b>
<b>6. ELECTRICAL CHARACTERISTIC .....</b>	<b>7</b>
6.1. DC Characteristics.....	7
6.2. Backlight Characteristics .....	8
<b>7. MODULE FUNCTION DESCRIPTION.....</b>	<b>9</b>
7.1. PIN DESCRIPTION .....	9
7.2. i80/16-bit System Bus Interface Timing Characteristics .....	10
7.3. i80/16-bit System interface .....	11
7.4. i80/16-bit System Bus Interface Timing(Register) .....	11
7.5. i80/16-bit System Bus Interface Timing(GRAM).....	12
7.6. Reset Timing Characteristics.....	12
<b>8. ELECTRO-OPTICAL CHARACTERISTICS.....</b>	<b>13</b>
8.1. Optical characteristics.....	13
8.2. CIE(x, y) chromaticity.....	13
<b>9. RELIABILITY .....</b>	<b>15</b>
9.1. MTTF.....	15
9.2. Tests.....	15
9.3. Color performance.....	15
<b>10. INSPECTION CRITERIA.....</b>	<b>16</b>
10.1. Inspection Conditions.....	16
10.2. Light Method .....	16
10.3. Classification Of Defects .....	16
10.4. Sampling & Acceptable Quality Level .....	17
10.5. Definition Of Inspection Area .....	17

10.6.	Items and Criteria.....	18
<b>11.</b>	<b>ILLUSTRATION OF LCD DATE CODE .....</b>	<b>21</b>
<b>12.</b>	<b>ROHS COMPLIANT WARRANTY .....</b>	<b>21</b>
<b>13.</b>	<b>PRECAUTIONS FOR USE .....</b>	<b>21</b>
13.1.	Safety.....	21
13.2.	Storage Conditions.....	21
13.3.	Installing LCD Module .....	21
13.4.	Precautions For Operation .....	22
13.5.	Handling Precautions .....	22
13.6.	Guarantee .....	23
<b>14.</b>	<b>REVISION HISTORY .....</b>	<b>23</b>

## 1. GENERAL DESCRIPTION

TVL-55736GD032JR-LW-G-AAN is a Transmissive type color active matrix liquid crystal display (LCD), which uses amorphous thin film transistor (TFT) as switching devices. This product is composed of a TFT LCD panel, driver ICs, FPC and a backlight unit. The following table described the features of TVL-55736GD032JR-LW-G-AAN.

## 2. FEATURES

Display Mode	Transmissive Type
	3.2" TFT LCD, Normally white type
Display Format	RGB vertical stripe
Driver IC.	ILI 9325C
Interface	8080 - system 16 bit Interface
Viewing Direction	Higher Contrast ratio: 9 o'clock
	Less gray scale reversal: 3 o'clock
Backlight type / color	LED / white *5

## 3. MECHANICAL SPECIFICATION

Item	Specifications	Unit
Dimensional outline	55.14(W)×78(H)×2.9(D)*	mm
Resolution	240×3(R,G,B)×320	dot
Active area	48.6(W)×64.8(H)	mm
Pixel pitch	0.2025(W)×0.2025(H)	mm

\* Without FPC

# 4. MECHANICAL DIMENSION

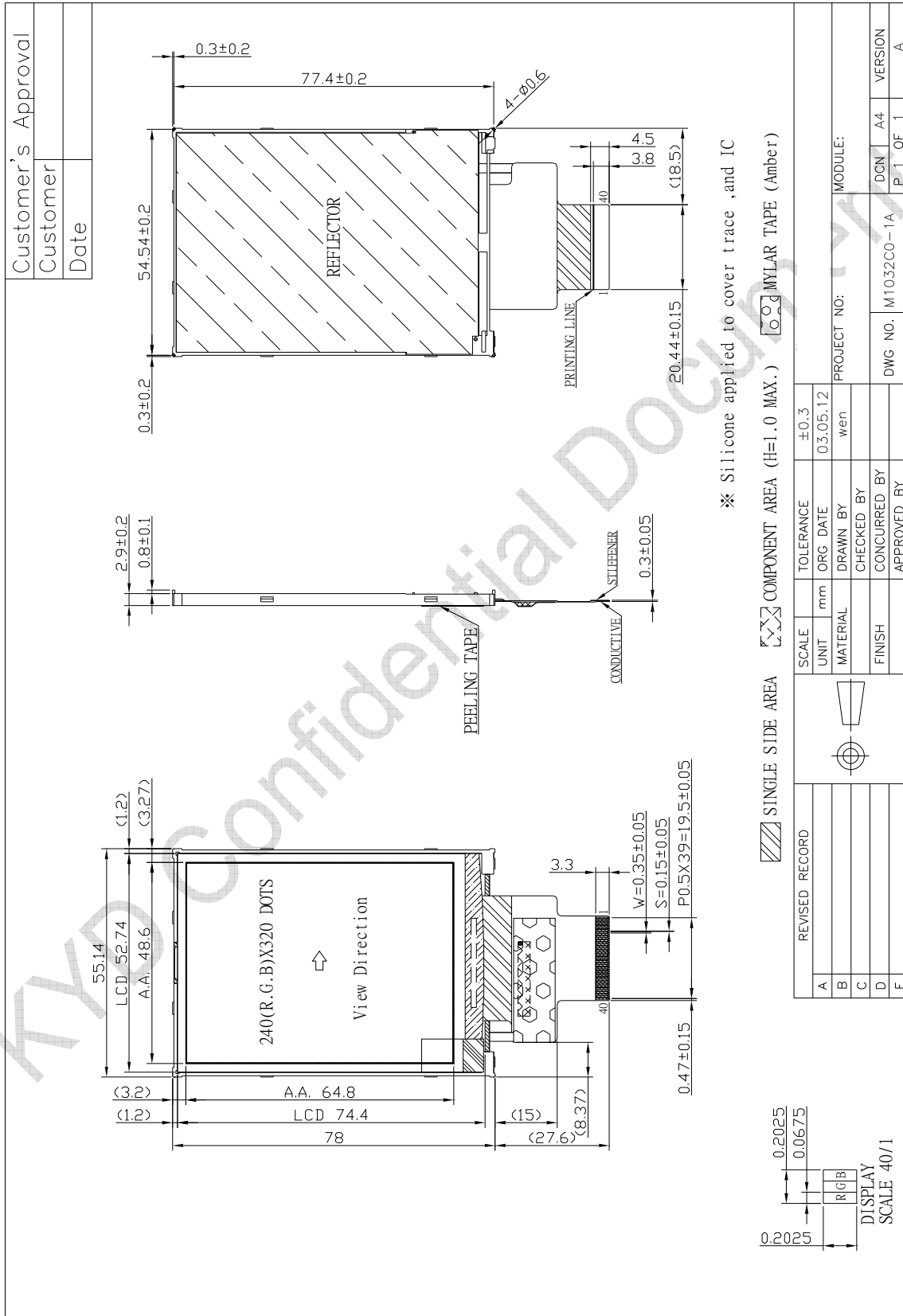

## 5. MAXIMUM RATINGS

ITEM	SYMBOL	MIN.	MAX.	UNIT	Note
Power Supply Voltage	V <sub>CC</sub>	2.5	3.3	V	
Logic input voltage range	V <sub>CC</sub> -GND	2.4	3.3	V	
Operation Temperature	T <sub>op</sub>	-20	70	°C	
Storage Temperature	T <sub>stg</sub>	-30	80	°C	
Humidity	-	-	90	%RH	Note1

Note 1: T<sub>A</sub> ≤ 40°C Without dewing

## 6. ELECTRICAL CHARACTERISTIC

### 6.1. DC Characteristics

(V<sub>CC</sub> = 2.4~3.3V, IOV<sub>CC</sub> = 1.65~3.3V)

Item	Symbol	Values			Unit
		Min.	Typ.	Max.	
IC Power Voltage	V <sub>CC</sub>	2.5	2.8	3.3	V
Consumption current of V <sub>CC</sub>	I <sub>CC</sub>	-	9.5	16	mA
Low Level Input Voltage	V <sub>IL</sub>	-0.3	-	0.2 x IOV <sub>CC</sub>	V
High Level Input Voltage	V <sub>IH</sub>	0.8 x IOV <sub>CC</sub>	-	IOV <sub>CC</sub>	V
Low Level Output Voltage	V <sub>OL</sub>	-	-	0.2 x IOV <sub>CC</sub>	V
High Level Output Voltage	V <sub>OH</sub>	0.8 x IOV <sub>CC</sub>	-	-	V

## 6.2. Backlight Characteristics

Item	Symbol	Condition	Min	Typ.	Max.	Unit
LED module Forward voltage	$V_{LED}$	$I_{LED}=20mA$	---	17.5	---	V
LED module current	$I_{LED}$	$V_{LED}=17.5V$	---	20	---	mA
Surface brightness uniform (without LCD)	$L_D$	$I_{LED}=20mA$ $V_{LED}=17.5V$	---	80	---	%

★ 1 Backlight LED Circuit :

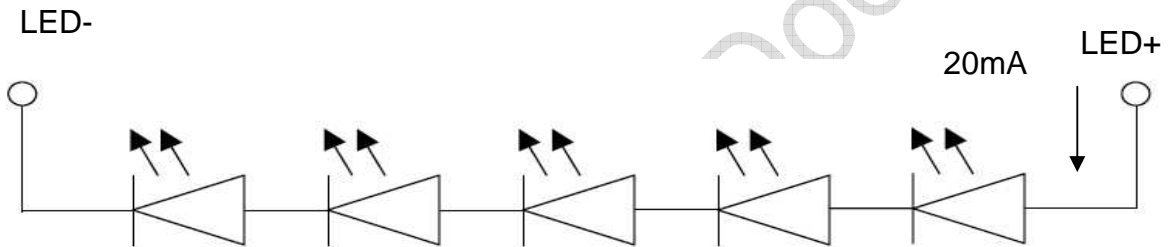

★2 Uniform measure condition :

- (a) Measure 9 point. Measure location is show below :
- (b)  $Uniform = (Min. \text{ brightness} / Max. \text{ brightness}) \times 100\%$
- (c) Best Contrast, Main and sub panel All dots turn ON (White screen)

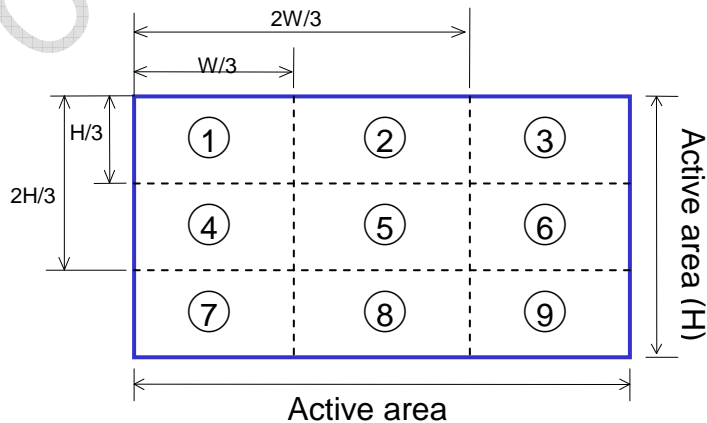



## 7. MODULE FUNCTION DESCRIPTION

### 7.1. PIN DESCRIPTION

Pin NO.	Symbol	Function
1	VCC	A supply voltage to the internal logic : Vcc = 2.4~3.3V
2	VCI	A supply voltage to the analog circuit. Connect to an external power supply of 2.5~3.3V
3	CS	A chip select signal. Low : the ILI9325C is selected and accessible High : the ILI9325C is not selected and not accessible. Fix to the GND level when not in use
4	DNC_SCL/RS	A register select signal. Low : select an index or status register High : select a control register
5	WR	A write strobe signal and enables an operation to write data when the signal is low
6	RD	A read strobe signal and enables an operation to read data when the signal is low
7	/RESET	A reset pin. Initializes the ILI9325C with a low input. Be sure to execute a power-on reset after supplying power
8	NC	No Connect
9 ~16	DB1 ~ DB8	Data bus pin
17	NC	No Connect
18~25	DB10~DB17	Data bus pin
26~38	GND	Power ground ◦ GND=0V ◦
39	LED +	B/L power supply
40	LED -	B/L power ground

## 7.2. i80/16-bit System Bus Interface Timing Characteristics

Normal write mode (IOVCC=1.65V~3.30V, VCC=2.4V~3.30V),

Item	Symbol	Unit	Min.	Typ.	Max.	Test Condition
Bus cycle time	Write	$t_{CYCW}$	ns	100	-	-
	Read	$t_{CYCR}$	ns	300	-	-
Write low-level pulse width	$PW_{LW}$	ns	50	-	500	-
Write high-level pulse width	$PW_{HW}$	ns	50	-	-	-
Read low-level pulse width	$PW_{LR}$	ns	150	-	-	-
Read high-level pulse width	$PW_{HR}$	ns	150	-	-	-
Write / Read rise / fall time	$t_{WRr}/t_{WRf}$	ns	-	-	25	-
Setup time	Write (RS to nCS, E/nWR)	$t_{AS}$	ns	10	-	-
	Read (RS to nCS, RW/nRD)			5	-	-
Address hold time	$t_{AH}$	ns	5	-	-	-
Write data set up time	$t_{DSW}$	ns	10	-	-	-
Write data hold time	$t_H$	ns	15	-	-	-
Read data delay time	$t_{DDR}$	ns	-	-	100	-
Read data hold time	$t_{DHR}$	ns	5	-	-	-

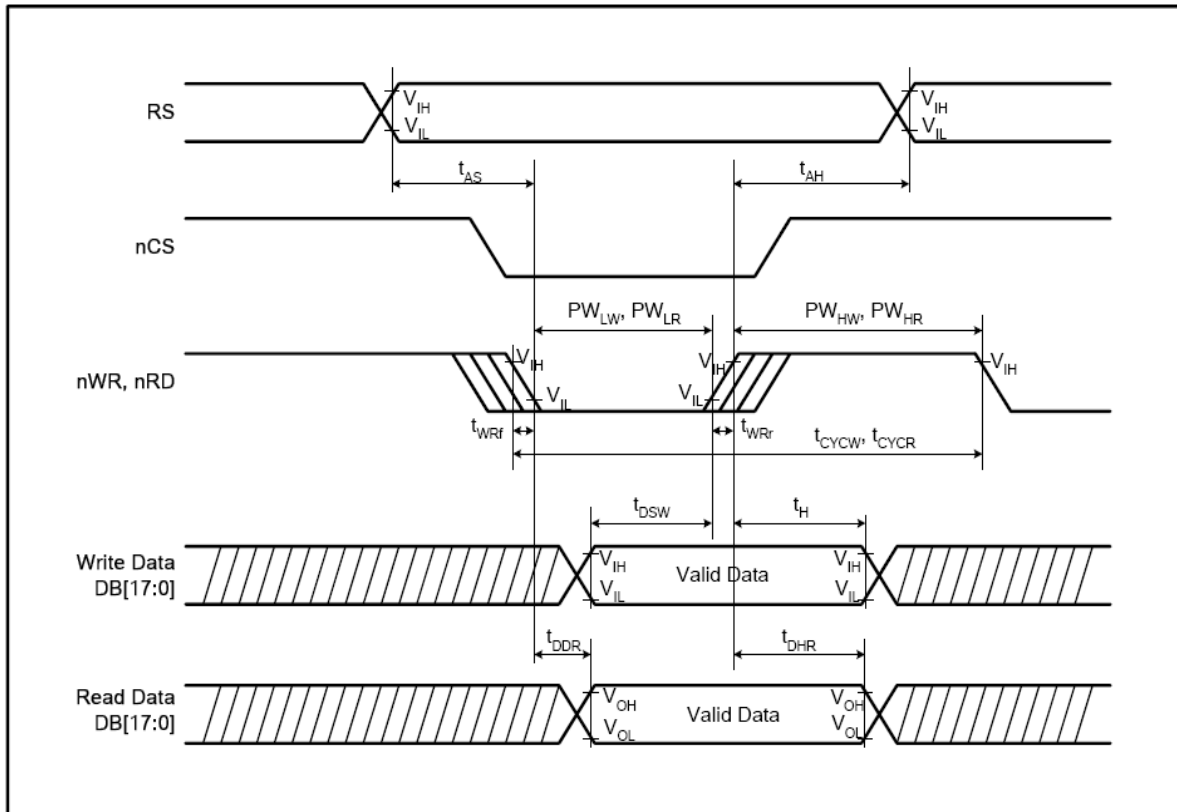

### 7.3. i80/16-bit System interface

TRI	DFM	16-bit MPU System Interface Data Format
0	*	<p>system 16-bit interface (1 transfers/pixel) 65,536 colors</p>
1	0	<p>80-system 16-bit interface (2 transfers/pixel) 262,144 colors</p>
1	1	<p>80-system 16-bit interface (2 transfers/pixel) 262,144 colors</p>

### 7.4. i80/16-bit System Bus Interface Timing(Register)

(a) Write to Register

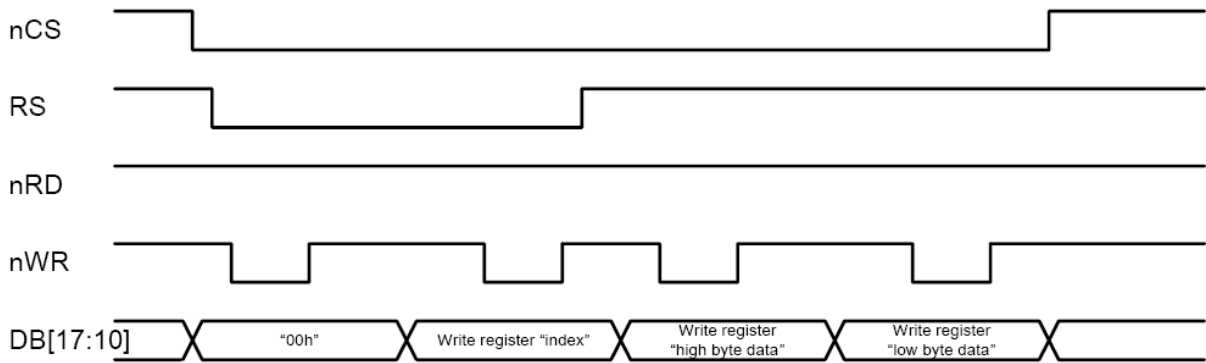

(b) Read to Register

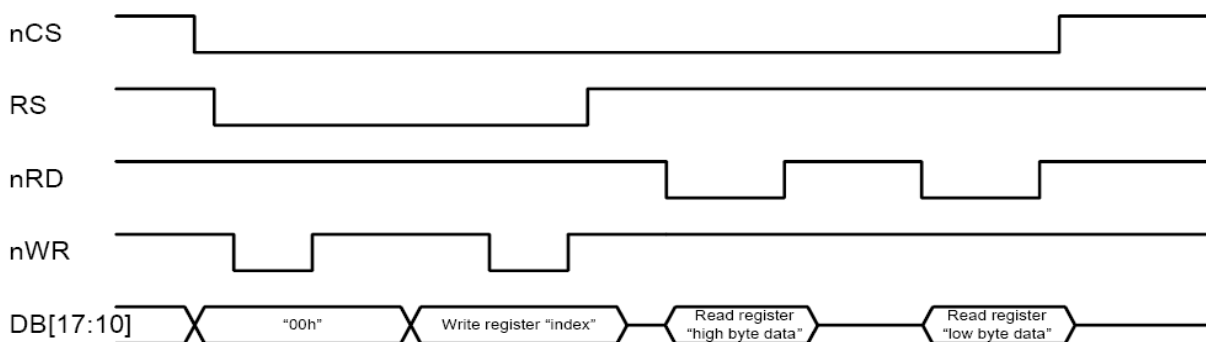

## 7.5. i80/16-bit System Bus Interface Timing(GRAM)

(a) Write to Register

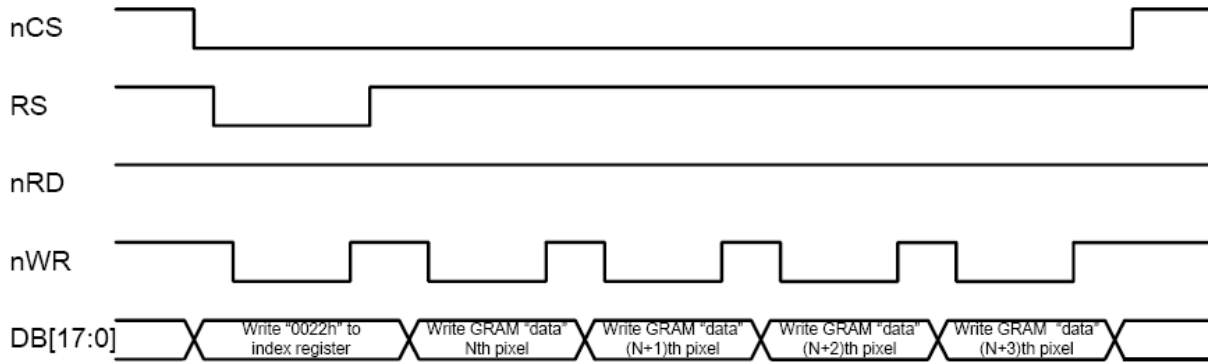

(b) Read to Register

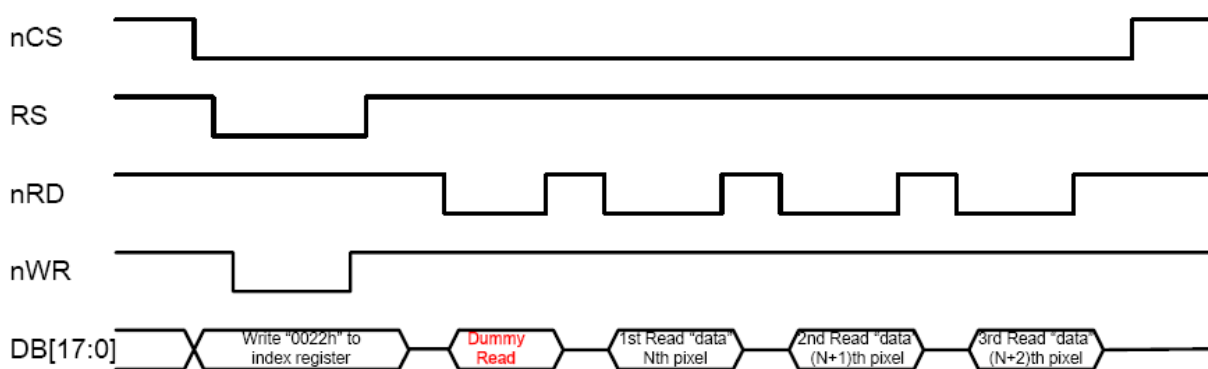

## 7.6. Reset Timing Characteristics

Reset Timing Characteristics (VCC = 1.8 ~ 3.3 V, IOVCC = 1.65 ~ 3.3 V)

Item	Symbol	Unit	Min.	Typ.	Max.
Reset low-level width	$t_{RES}$	ms	1	-	-
Reset rise time	$t_{RES}$	$\mu$ s	-	-	10



## 8. ELECTRO-OPTICAL CHARACTERISTICS

### 8.1. Optical characteristics

Item	Symbol	Temp.	Min.	Typ.	Max.	Unit	Conditions	
Response time	Tr	25°C	-	11	12	ms	NOTE 3	
	Tf	25°C	-	14	18	ms		
Luminance	L	25°C	220	250	-	cd/m <sup>2</sup>	-	
Contrast ratio	CR	25°C	230	250	-	-	NOTE 1	
Viewing Angle	Vertical	$\theta+$	25°C	50	60	-	Degree	NOTE 2
		$\theta-$		50	60	-		
	Horizontal	$\Psi+$	25°C	30	50	-	Degree	NOTE 2
		$\Psi-$		50	60	-		

### 8.2. CIE(x, y) chromaticity

Item	Symbol	Transmissive			Conditions
		Min.	Typ.	Max.	
Red	X	-	0.634	-	$\theta = 0^\circ$ , $\phi = 0^\circ$
	y	-	0.348	-	
Green	X	-	0.364	-	$\theta = 0^\circ$ , $\phi = 0^\circ$
	y	-	0.559	-	
Blue	X	-	0.144	-	$\theta = 0^\circ$ , $\phi = 0^\circ$
	y	-	0.086	-	
White	X	-	0.292	-	$\theta = 0^\circ$ , $\phi = 0^\circ$
	y	-	0.299	-	

NOTE 1: Definition of contrast ratio:

Measure contrast ratio on the below 5 points and take average value ◦

Contrast ratio is calculated with the following formula:

$$\text{Contrast Ratio (CR)} = (\text{White}) \text{Luminance of ON} \div (\text{Black}) \text{Luminance of OFF}$$

NOTE 2: Definition of Viewing Angle (  $\theta$  ,  $\Psi$  )

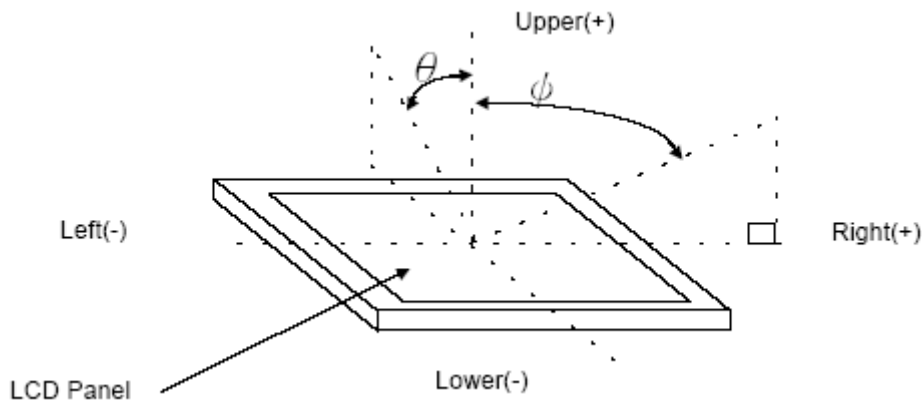

NOTE 3: Definition of Response Time

The response time is defined as the time interval between the 10% and 90% amplitudes ◦

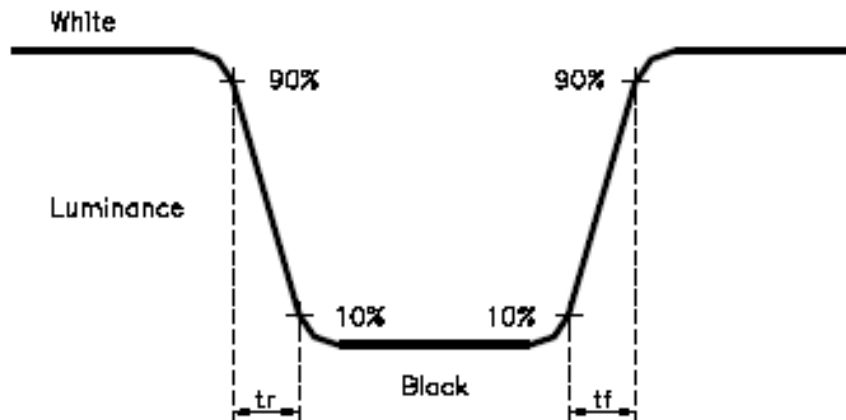

## 9. RELIABILITY

### 9.1. MTTF

The LCD module shall be designed to meet a minimum MTTF value of 50,000 hours with normal condition. (25°C in the room without sunlight; not include life time of backlight)

### 9.2. Tests

NO.	ITEM	CONDITION	CRITERION
1	High Temperature Operating	70°C 240 hrs	<ul style="list-style-type: none"> <li>◦ No Defect Of Operational Function In Room Temperature Are Allowable(23±5°C).</li> <li>◦ Leakage current should be below double of initial value.</li> </ul>
2	Low Temperature Operating	-20°C 240 hrs	
3	High Temperature Non-Operating	80°C 240 hrs	
4	Low Temperature Non-Operating	-30°C 240 hrs	
5	High Temperature/ Humidity Non-Operating	50°C ,90%RH 240 hrs	
6	Temperature Shock Non-Operating	-30°C ( 30min ) ↔ 80°C ( 30min ) 10 CYCLES	
7	Electrostatic Discharge Test Non-Operating	HBM:±2KV	

Note 1: Test after 24 hours in room temperature(23±5°C).

Note 2: The sampling above is individually for each reliability testing condition.

Note 3: The color fading of polarizing filter should not care.

Note 4: All of the reliability testing chamber above, is using D.I. water.(Min value:

1.0 MΩ -cm)

Note 5: In case of malfunction defect caused by ESD damage, if it would be recovered to normal state after resetting, it would be judged as a good part.

### 9.3. Color performance

No.	ITEM	Criterion (initial)
1	Luminance	>50%
2	NTSC	>70%
3	Contrast Ratio	>50%

## 10. INSPECTION CRITERIA

### 10.1. Inspection Conditions

#### 10.1.1. Environmental conditions

The environmental conditions for inspection shall be as follows

Room temperature:  $23\pm 5^{\circ}\text{C}$

Humidity:  $50\pm 20\% \text{RH}$

#### 10.1.2. The external visual inspection

With a single  $1000\pm 200$ lux fluorescent lamp as the light source, the inspection was in the distance of 30cm or more from the LCD to the inspector's eyes.

### 10.2. Light Method

10.2.1. Environment lamp under  $1000\pm 200$  lux, Viewing direction for inspection over 30 cm

10.2.2. The distance from eye to defect around 300mm, the distance from ND Filter to defect around 25~30mm

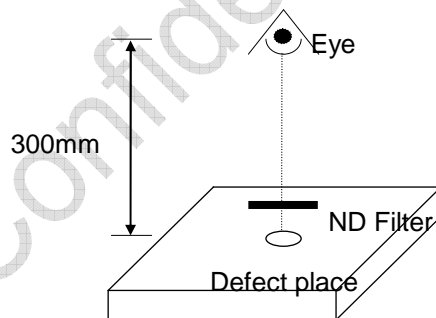

### 10.3. Classification Of Defects

#### 10.3.1. Major defect

A major defect refers to a defect that may substantially degrade usability for product applications.



### 10.3.2. Minor defect

A minor defect refers to a defect which is not considered to be able substantially degrade the product application or a defect that deviates from existing standards almost unrelated to the effective use of the product or its operation.

Notes: If the LCD/LCM 's cosmetic and display performance do not specify in "inspection criterion", it should be based on these delivered samples.

## 10.4. Sampling & Acceptable Quality Level

Level II, MIL-STD-105E

	Major	Minor
Cosmetic	1.0 %	1.5 %
Electrical-display	0.4%	0.65 %

## 10.5. Definition Of Inspection Area

V.A: Viewing Area

A.A: Active Area

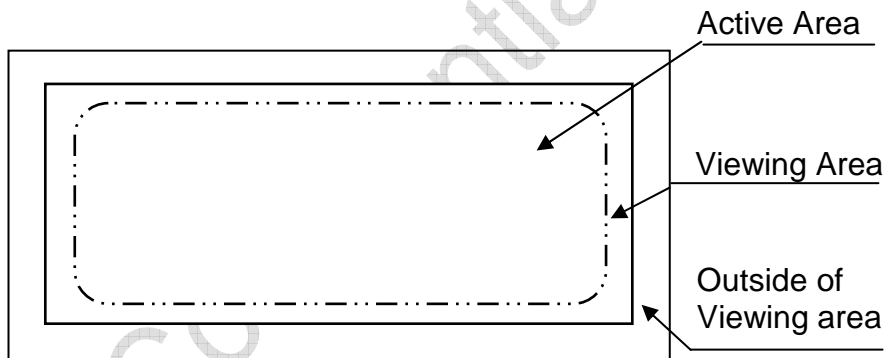

## 10.6. Items and Criteria

### 10.6.1. Visual inspection criterion in cosmetic

#### (1) Glass defect

No	Defect	Criteria	Remark
1	Dimension (Minor)	By engineering diagram	
2	Cracks (Major)	Extensive crack <b>【Reject】</b>	

#### (2) LCM appearance defect

No	Defect	Criteria		Remark
1	Round type (Minor)	Spec.	Permissible Qty	1. $\psi = (L+W)/2$ , L: Length, W: Width 2. Disregard if out of A.A. 
		$\psi \leq 0.10\text{mm}$	Disregard	
		$0.10\text{mm} < \psi \leq 0.20\text{mm}$	3	
		$0.20\text{mm} < \psi$	0	
2	Line type (Minor)	Spec.	Permissible Qty	1. L: Length, W: Width 2. Disregard if out of A.A. 
		$W \leq 0.03\text{mm}$	Disregard	
		$L \leq 3.0\text{mm}$ and $0.03\text{mm} < W \leq 0.05\text{mm}$	2	
		$L \leq 3.0\text{mm}$ and $0.05\text{mm} < W \leq 0.10\text{mm}$	1	
		$W > 0.10\text{mm}$ or $L > 3.0\text{mm}$	0	
3	Polarizer dent (Minor)	Spec.	Permissible Qty	1. $\psi = (L+W)/2$ , L: Length, W: Width 2. Disregard if out of A.A. 
		$\psi \leq 0.20\text{mm}$	Disregard	
		$0.20\text{mm} < \psi \leq 0.30\text{mm}$	2	
		$0.30\text{mm} < \psi \leq 0.50\text{mm}$	1	
		$0.50\text{mm} < \psi$	0	

(3) FPC

No	Defect	Criteria	Remark
1	Copper peeling (Minor)	Copper peeling <b>【Reject】</b>	



(4) Black tape

No	Defect	Criteria	Remark
1	Shift (Minor)	IC exposed <b>【Reject】</b>	
2	No black tape (Minor)	No black tape <b>【Reject】</b>	

(5) Silicon

No	Defect	Criteria	Remark
1	Amount of silicon (Minor)	ITO exposed <b>【Reject】</b>	

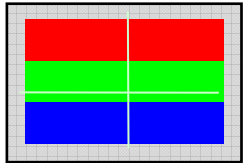
10.6.2. Visual inspection criterion in electrical display

No	Defect	Criteria	Remark
1	No display (Major)	Not allowed	
2	Missing line (Major)	Not allowed	
3	Darker or lighter line (Major)	Not allowed	

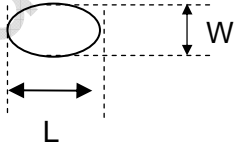
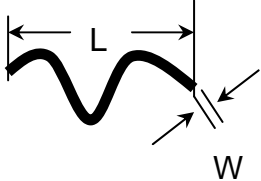
4	Weak line (Minor)	By limited sample		
No	Defect	Criteria		Remark
5	Bright / Dark point (Minor)	Spec.	Permissible Qty	1:1sub-pixel: 1R or 1G or 1B 2:Point defect area $\geq$ 1/2 sub pixel.
		Bright point	1	
		Dark point	2	
6	Round type (Minor)	Spec.	Permissible Qty	1. $\psi = (L+W)/2$ , L: Length, W: Width 2. Disregard if out of A.A. 
		$\psi \leq 0.10\text{mm}$	Disregard	
		$0.10\text{mm} < \psi \leq 0.20\text{mm}$	3	
		$0.20\text{mm} < \psi$	0	
7	Line type (Minor)	Spec.	Permissible Qty	1. L: Length, W: Width 2. Disregard if out of A.A. 
		$W \leq 0.03\text{mm}$	Disregard	
		$L \leq 3.0\text{mm}$ and $0.03\text{mm} < W \leq 0.05\text{mm}$	2	
		$L \leq 3.0\text{mm}$ and $0.05\text{mm} < W \leq 0.10\text{mm}$	1	
		$W > 0.10\text{mm}$ or $L > 3.0\text{mm}$	0	
8	Mura (Minor)	By 5% ND filter invisible		

## 10.6.3. Others

- Issues that are not defined in this document shall be discussed and agreed with both parties. (Customer and supplier)
- Unless otherwise agreed upon in writing, the criteria shall be applied to both parties. (Customer and supplier)
- Polarizer, more than 0.5mm in size reduction rejected.

## 11. ILLUSTRATION OF LCD DATE CODE

( TBD )

## 12. RoHS COMPLIANT WARRANTY

RoHS Hazardous substances including:

- Cd < 100 ppm
- Pb < 1000 ppm
- Hg < 1000 ppm
- Cr +6 < 1000 ppm
- PBDE < 1000 ppm
- PBB < 1000 ppm

## 13. PRECAUTIONS FOR USE

### 13.1. Safety

- (1) Do not swallow any liquid crystal, even if there is no proof that liquid crystal is poisonous.
- (2) If the LCD panel breaks, be careful not to get liquid crystal to touch your skin.
- (3) If skin is exposed to liquid crystal, wash the area thoroughly with alcohol or soap.

### 13.2. Storage Conditions

- (1) Store the panel or module in a dark place where the temperature is  $23\pm 5^{\circ}\text{C}$  and the humidity is below  $50\pm 20\%\text{RH}$ .
- (2) Store in anti-static electricity container.
- (3) Store in clean environment, free from dust, active gas, and solvent.
- (4) Do not place the module near organics solvents or corrosive gases.
- (5) Do not crush, shake, or jolt the module.
- (6) Do not exposed to direct sun light of fluorescent lamps.

### 13.3. Installing LCD Module

Attend to the following items when installing the LCM.

- (1) Cover the surface with a transparent protective plate or touch panel to protect the polarizer and LC cell.

### 13.4. Precautions For Operation

- (1) Viewing angle varies with the change of liquid crystal driving voltage ( $V_o$ ). Adjust  $V_o$  to show the best contrast.
- (2) Driving the LCD in the voltage above the limit will shorten its lifetime.
- (3) Response time is greatly delayed at temperature below the operating temperature range. However, this does not mean the LCD will be out of the order. It will recover when it returns to the specified temperature range.
- (4) When turning the power on, input each signal after the positive/negative voltage becomes stable.
- (5) Do not apply mater or any liquid on product, which composed of T/P.

### 13.5. Handling Precautions

- (1) Avoid static electricity that can damage the CMOS LSI; please wear the wrist strap when handling.
- (2) The polarizing plate of the display is very fragile. So, please handle it very carefully.
- (3) Do not give external shock.
- (4) Do not apply excessive force on the surface; it may cause display abnormal.
- (5) Do not wipe the polarizing plate with a dry cloth, as it may easily scratch the surface of plate.
- (6) Do not use ketonics solvent & Aromatic solvent, use with a soft cloth soaked with a cleaning naphtha solvent.
- (7) Do not operate it above the absolute maximum rating.
- (8) Do not remove the panel or frame from the module.
- (9) Do not apply mater or any liquid on product, which composed of T/P.

## 13.6. Guarantee

13.6.1. The period is within 12 months since the date of shipping out under normal using and storage conditions.

13.6.2. Any defect not caused by KYOCERA DISPLAY is not guaranteed to the customer. The defect phenomenon should be agreed by both parties.

## 14. REVISION HISTORY

Version	Revise record	Date
A	New version	2012/03/05
B	Viewing Direction remark	2012/04/24