A large, light blue decorative graphic consisting of a thick, curved line that forms a partial circle, with a smaller circle at its top end, is centered on the page.

Phase Cut Dimmable Non-isolated Buck Converter for LED Retrofit Bulb with **ICL8002G & CoolMOS™ 600V C6**

Application Note

Revision 1.1, 2012 -08 -03

Edition 2012-08-03
Published by
Infineon Technologies AG
81726 Munich, Germany
© 2012 Infineon Technologies AG
All Rights Reserved.

Legal Disclaimer

The information given in this document shall in no event be regarded as a guarantee of conditions or characteristics. With respect to any examples or hints given herein, any typical values stated herein and/or any information regarding the application of the device, Infineon Technologies hereby disclaims any and all warranties and liabilities of any kind, including without limitation, warranties of non-infringement of intellectual property rights of any third party.

Information

For further information on technology, delivery terms and conditions and prices, please contact the nearest Infineon Technologies Office (www.infineon.com).

Warnings

Due to technical requirements, components may contain dangerous substances. For information on the types in question, please contact the nearest Infineon Technologies Office.

Infineon Technologies components may be used in life-support devices or systems only with the express written approval of Infineon Technologies, if a failure of such components can reasonably be expected to cause the failure of that life-support device or system or to affect the safety or effectiveness of that device or system. Life support devices or systems are intended to be implanted in the human body or to support and/or maintain and sustain and/or protect human life. If they fail, it is reasonable to assume that the health of the user or other persons may be endangered.



ICL8002G

Revision History: 2012-08-03, Version 1.1

Previous Version: 1.0

Page	Subjects (major changes since last revision)
17	Add "Production Tolerance and Normal Distribution"

1	Introduction	5
2	List of Features	5
3	Technical Specification	5
4	Demo Board	6
5	Schematic	6
6	TRIAC Based Dimmer Compatibility	6
7	Single Stage Power Factor Correction	7
8	Line Regulation	8
9	Setup and Results	9
9.1	Input / Output	9
9.1.1	Input	9
9.1.2	Output	9
9.2	Power Up	9
9.3	Operation Waveforms	9
9.4	Output Waveforms	10
9.5	Input Waveforms	11
9.6	Power Factor Correction	11
9.7	Output current regulation	12
9.8	Phase Cut Dimming	13
9.8.1	Test set-up	13
9.8.2	Waveforms during dimming	13
9.8.3	List of compatible TRIAC dimmers	14
9.9	System Efficiency	14
9.10	Protection Functions	15
9.10.1	Output Open Circuit Protection	15
9.10.2	Output Short-circuit Protection	15
9.11	Conducted EMI	16
10	Production Tolerance and Normal Distribution	17
11	Board Layout	18
12	BOM and Power Inductor Spec	19
12.1	Bill of Material	19
12.2	Power Inductor	20
13	Common Questions and Troubleshooting Hints	21
13.1	Q&A	21
13.2	Design and Troubleshooting Hints	21
14	References	22

1 Introduction

ICL8002G is a quasi-resonant PWM controller specially designed for high efficient offline LED driving application. It can be configured for different topologies such as flyback and buck converter. This document illustrates the ICL8002G in dimmable LED bulb application using the non-isolated buck topology. The ICL8002G IC's quasi-resonant operation mode, precise cycle-by-cycle peak current control, integrated PFC and phase-cut dimming control, and various protections make it an outstanding system solution for dimmable LED bulbs.

The ICL8002G non-isolated bulb demo board shows high efficiency and power factor with single stage design. Damping and bleeder circuit blocks were added to achieve high compatibility with wide range of dimmers. The output current is well regulated over a wide input and output voltage range. Its compact form factor makes it easy to fit into many LED lamp shapes and sizes.

Other available demo boards for ICL8001G/ICL8002G are designed with isolated flyback topology. If galvanic isolation is not required, a non-isolated buck topology can be used with the following advantages:

- Lower PCBA BOM cost due to less costly power inductor and lower voltage rated MOSFET
- Smaller form factor due to more compact size of the power inductor

This demo board can be ordered with the sales code EVALLED-ICL8002G-B2.

2 List of Features

- Smooth dimming curve with high dimmer compatibility
- High efficiency (>86%)
- High power factor (>0.95) with low THD (<20%)
- Small form factor (40mm x 20mm x 25mm)
- Quasi-resonant floating buck operation
- Precise cycle-by-cycle peak current control
- Integrated start-up power cell and built-in digital soft-start
- Comprehensive protection functions
- Low system BOM cost for dimmable bulbs

3 Technical Specification

Table 1 lists the performance specification of the EVALLED-ICL8002G-B2 demo board.

Table 1 Design Specification

Parameter	Value	Unit
Input voltage	90-132	V
Line frequency	50/60	Hz
Input power*	12	W
Output power*	10	W
Output voltage	30-38	V
Output current	300	mA
Power factor	> 0.95	
THD**	< 20%	
Efficiency**	86%	

*: Actual input and output power depends on the output voltage **: Measured at 120Vac with output of 34.3V/295mA

4 Demo Board

Both top and bottom side of the demo board EVALLED-ICL8002G-B2 are shown in [Figure 1](#).

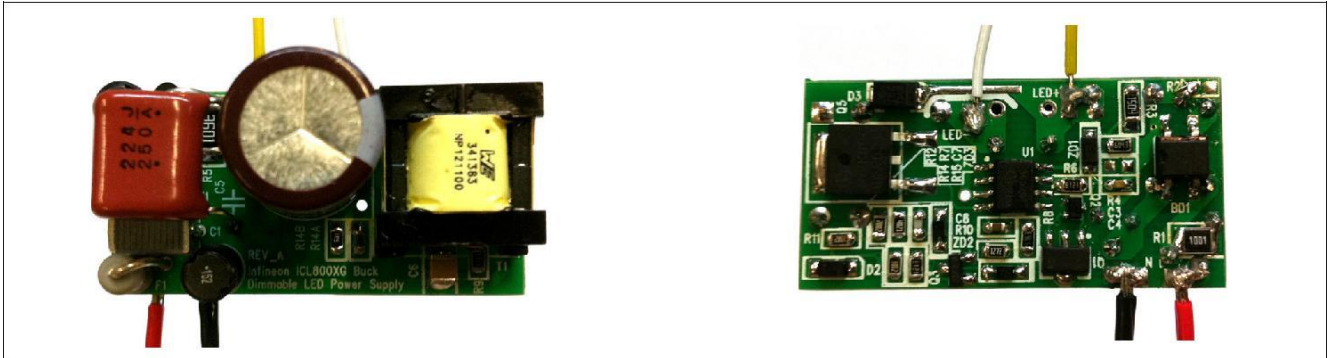

Figure 1 EVALLED-ICL8002G-B2 demo board (Dimension: 40x20x25mm)

5 Schematic

[Figure 2](#) shows the schematic for a 10W non-isolation dimmable LED bulb application designed with ICL8002G.

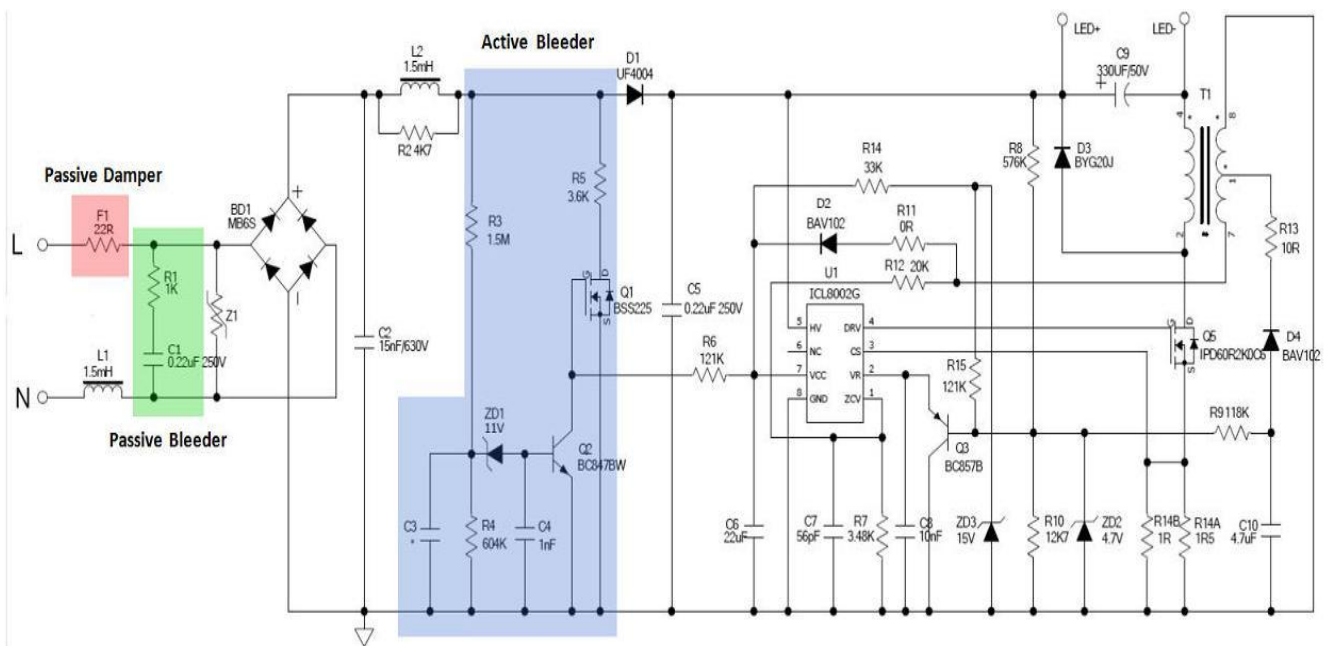

Figure 2 EVALLED-ICL8002G-B2 schematic

6 TRIAC Based Dimmer Compatibility

TRIAC based dimmers work smoothly with resistive loads such as incandescent lamps. However, when connected to non-resistive loads such as switch mode LED drivers flickering issue can happen primarily due to insufficient hold-up current and due to current oscillation especially during TRIAC firing. Therefore, to improve compatibility with TRIAC based dimmers, usually bleeder circuit and damping circuit are implemented in the LED drivers.

In this design, the fusible resistor F1 is functioning as a fuse as well as a damping element to reduce oscillation and inrush current. Moreover, both passive bleeder circuit (formed by R1 and C1) and active bleeder circuit (formed by R3-R6, C3, C4, ZD1, Q1, and Q2) are incorporated to maintain input current above the hold-up current

threshold of the TRIAC. When the input voltage is low, ZD1 as well as Q2 will not conduct. Q1's gate is charged by Vcc through R6. When Q1 turns on, the current through R5 helps the TRIAC maintain conduction. As input voltage rises, ZD1 will pass current to trigger Q2. Once Q2 is on, Q1's gate will discharge, turning off Q1. Meanwhile TRIAC's current is high enough for it to remain in conduction due to the increased current drawing by the buck converter.

7 Single Stage Power Factor Correction

Single stage power factor correction (PFC) allows for a highly efficient, cost effective and compact LED driver. In this demo board design, PFC is achieved by sensing the input mains voltage (via R8 and R10) and regulating the peak current of the coupled inductor T1's main winding (Pin 4 to Pin2) during each switching cycle to be proportional to the input voltage.

The formula describing the relationship between the peak current and VR pin's voltage is given by:

$$I_{p-pk}(t) = \frac{V_{VR}(t) V_{PWM}}{G_{PWM} R_{CS}} \cdot \frac{V_1(t) V_{be} V_{PWM}}{G_{PWM} R_{CS}} \cdot \frac{V_1(t)}{G_{PWM} R_{CS}} \quad (1)$$

where $I_{p-pk}(t)$ is the peak current of the transformer's primary winding; $V_{VR}(t)$ is the VR pin's voltage; $V_1(t)$ is the input voltage sensing signal at the base of Q3; V_{be} is the transistor Q3's base to emitter voltage; V_{PWM} is the IC's internal offset voltage with typical value of 0.7V, which is compensated by Q3's V_{be} ; G_{PWM} is the IC's PWM gain; and R_{CS} is the current sense resistor.

The ICL8002G operates the buck converter in quasi-resonant PWM mode, that means, the current of the inductor's main winding is in critical conduction mode. The high frequency sawtooth current in the main winding is filtered by the output capacitor before flowing to the LED load. Meanwhile the high frequency component of the input current is filtered by LC filters formed by L1, L2, C2, and C5. Input voltage and current waveforms in half an AC cycle are illustrated in [Figure 3](#).

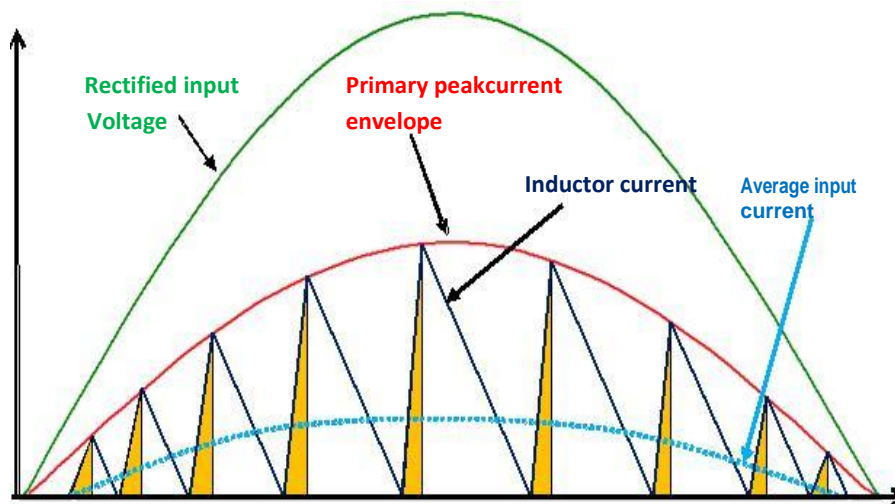

Figure 3 Voltage and current waveforms in half an AC cycle

As can be noted from [Figure 3](#), the averaged input current is shaped to be approximately sinusoidal and thus high power factor is achieved, with input current harmonics fulfilling the requirements of EN 61000-3-2 and ANSI C82.77-2002 standard.

The average output current mainly depends on the peak current of the main winding. As a rule of thumb, the average output current can be calculated as

$$I_o = 0.29 I_{p\ pk} \quad (2)$$

It can be also noted that the switching frequency varies with the instantaneous line voltage and reaches minimum value when minimum line voltage reaches its peak value. Ignoring the zero crossing detection delay and voltage drop on the MOSFET, shunt resistor, and the freewheeling diode, the minimum frequency is given by:

$$f_{\text{MIN}} = \frac{1}{T_{\text{on}} + T_{\text{off}}} = \frac{1}{L_p I_{p\ pk} \left(\frac{1}{V_{\text{in_MIN}}} + \frac{1}{\sqrt{2} V_o} \right)} = \frac{V_o (V_{\text{in_MIN}} \sqrt{2} V_o)}{L_p I_{p\ pk} \sqrt{2} V_o} \quad (3)$$

where T_{on} and T_{off} are the ON and OFF time of the MOSFET respectively; L_p is the inductance value of the inductor main winding; $V_{\text{in_min}}$ is the minimum line voltage as specified in the design specification; and V_o is the output voltage.

Considering the system's form factor, efficiency, and EMI performance, it is recommended to set minimum switching frequency to between 80kHz and 100kHz by choosing proper primary inductance value.

8 Line Regulation

The power factor correction scheme described above also indicates that with higher input voltage, the output current tends to increase due to higher VR pin voltage. Therefore to produce a stable output current (and lumen output) versus mains voltage variations it is necessary to implement some compensation scheme to achieve good line regulation.

In this design, the line regulation is achieved by the IC's integrated foldback correction function as well as the circuitry formed by R9, C10, D4, and R13. IC's ZCV pin is able to detect the input voltage level through R12 and the Vcc winding (T1's Pin 7 to Pin8), allowing the IC to vary primary current sense voltage limit according to the input voltage level. This means the primary current will be decreased when the input voltage increases. The extent of the compensation can be adjusted with varying the value of R12.

Meanwhile C10, together with D4 and the transformer's auxiliary winding (Pin1 to Pin8) will produce a negative voltage which is proportional to the rectified input voltage. With a proper value of R9, the peak voltage level at the base of Q3, and thus VR pin's voltage, will be regulated against line voltage variation. The circuit formed by R14, R15 and ZD3 will add a DC offset to the base of Q2 to prevent it from going to a negative voltage. This offset alters the peak level of VR's voltage and as a result determines the output current.

Fine tuning of resistance value of R9 is necessary to provide optimum compensation to the line voltage variation. As a rule of thumb, R9 can be calculated with the following formula:

$$R9 = R8 \frac{N_{\text{aux}}}{N_p} \quad (4)$$

where N_{aux} and N_p are the number of turns of the coupled inductor T1's auxiliary winding (Pin1 to Pin8) and main inductor winding (Pin2 to Pin4) respectively.

9 Setup and Results



ATTENTION: LETHAL VOLTAGES ARE PRESENT ON THIS DEMO BOARD. DO NOT OPERATE THE BOARD UNLESS YOU ARE TRAINED TO HANDLE HIGH VOLTAGE CIRCUITS. DO NOT LEAVE THIS BOARD UNATTENDED WHILE IT IS POWERED UP.

9.1 Input / Output

9.1.1 Input

Connect AC line (**90V-132V**) to the red (Hot) and black (Neutral) wires. For dimming operation the phase cut dimmer shall be connected to the input according to the dimmer's instructions by its manufacturer.

9.1.2 Output

Connect LED module (**30V-38V/300mA**) to the yellow (positive) and white (negative) wires from the demo board.

Attention: As this is a NON-isolated design, high voltage exists at the output! An isolated AC source at the input is advised to be used during evaluation of this demo board.

9.2 Power Up

The ICL8002G integrates a start-up cell to charge up the Vcc capacitor until it starts up successfully. **Figure 4** demonstrates the start-up waveforms from mains voltage switch-on to light output.

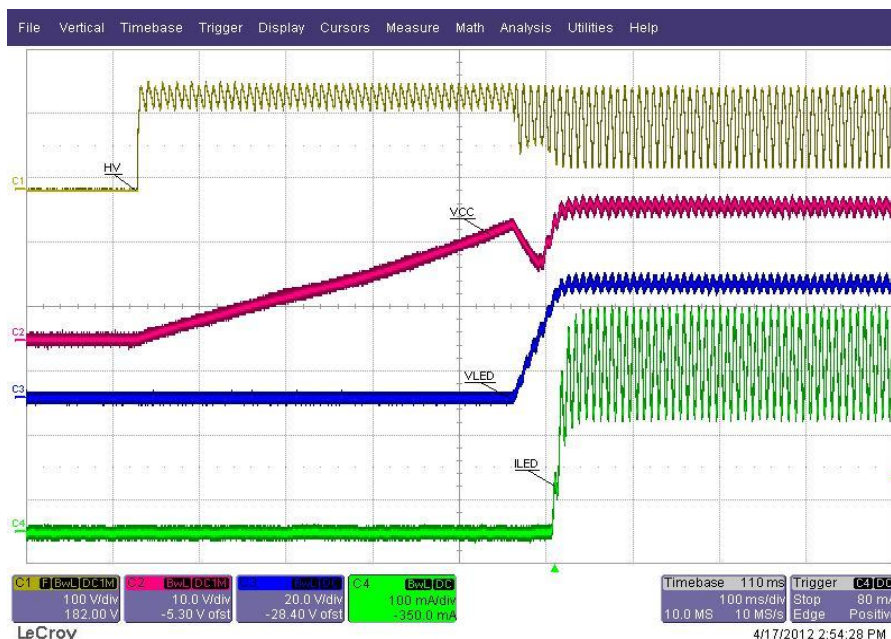

Figure 4 Start-up waveforms: Rectified mains input voltage (C1, yellow), Controller Vcc (C2, red), output voltage (C3, blue), and output current (C4, green)

9.3 Operation Waveforms

The ICL8002G is a quasi-resonant PWM controller and operates the buck converter in critical conduction mode. Through zero crossing detection via ZCV pin, the ICL8002G turns on MOSFET when its drain voltage drops to the

first valley point. This helps to reduce current spike as well as switching loss and thus improve both efficiency and EMI performance. **Figure 5** shows typical switching waveforms.

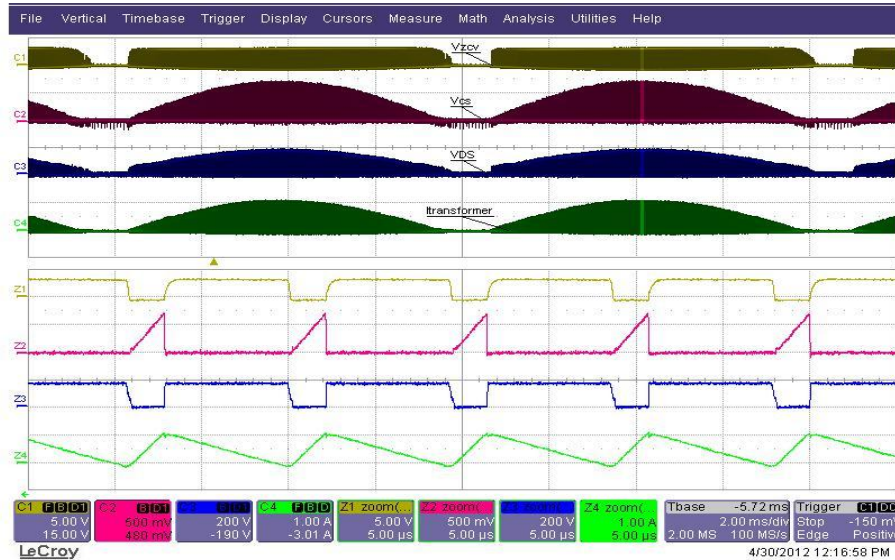

Figure 5 Typical operation waveforms: ZCV pin voltage (C1&Z1, yellow), shunt signal Vcs (C2&Z2, red), drain voltage Vds (C3&Z3, blue) and primary winding’s current (C4&Z4, green) showing quasi-resonant switching

9.4 Output Waveforms

The single stage PFC design inevitably produces double mains frequency ripple at the output. Increasing output capacitance value helps reduce output ripple. However, this is often at the expense of the system’s form factor. In this demo board design, the output capacitor (C9) is sized for an output current ripple which exhibits no visible light modulation. **Figure 6** shows the measured waveforms of output voltage and output current. The modulation depth of the current ripple is about 25%.

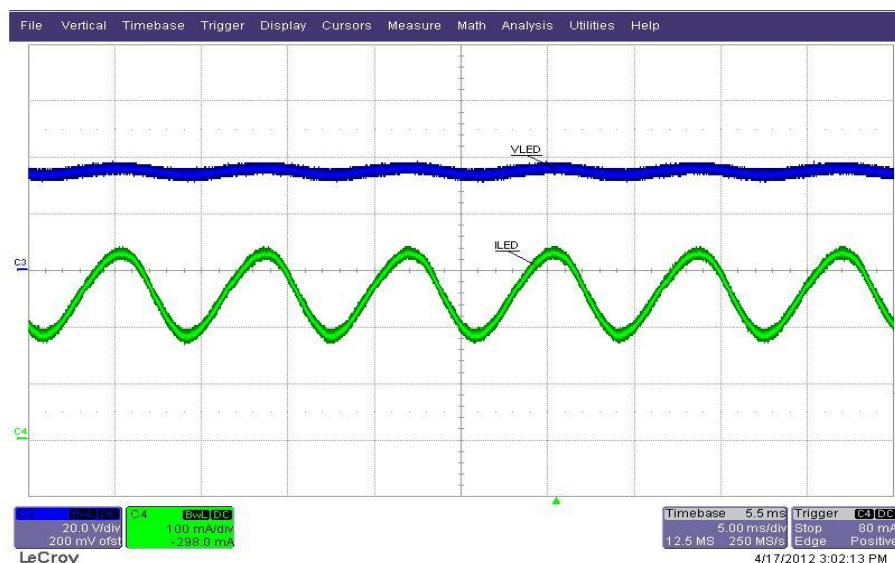

Figure 6 Typical waveforms: Output voltage (C2, blue) and output current (C4, green)

9.5 Input Waveforms

Figure 7 shows the waveforms of input voltage, input current, and the current shunt voltage during normal operation at 120Vac and full load.

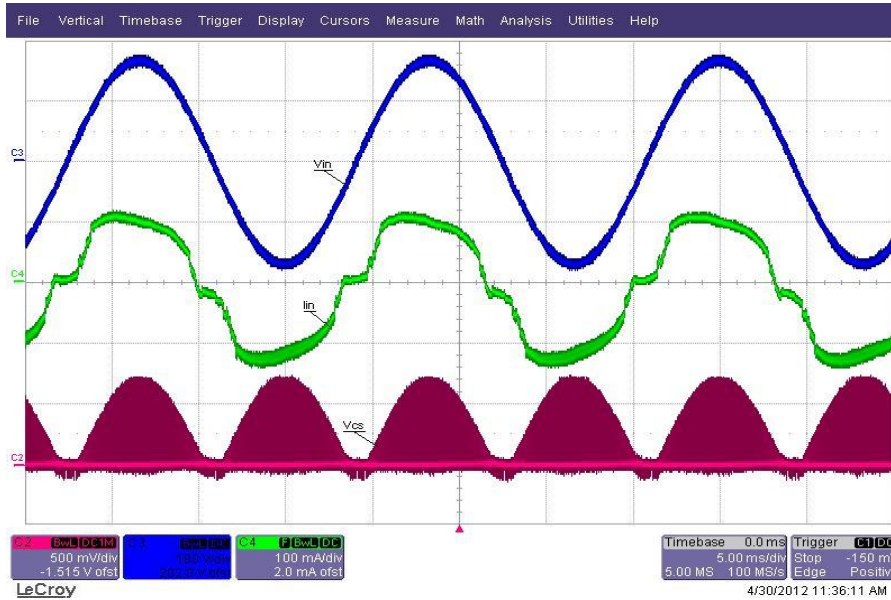

Figure 7 Input voltage V_{in} (C2, blue), Input current I_{in} (C4, green) and shunt voltage V_{cs} (C2, red)

9.6 Power Factor Correction

The measured power factor and total harmonics distortion (THD) at different input voltages are shown in Figure 8. The power factor is above 0.95 over the whole input voltage range.

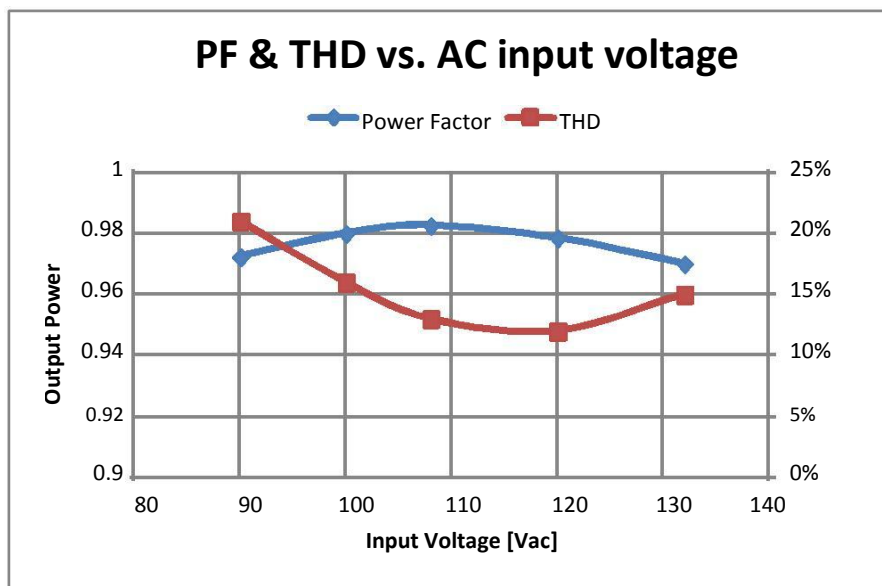

Figure 8 Power Factor and THD versus line voltage

9.7 Output current regulation

Figure 9 shows the LED driver system's output current versus line voltage. The output current is regulated within +/-3% over the whole input voltage range.

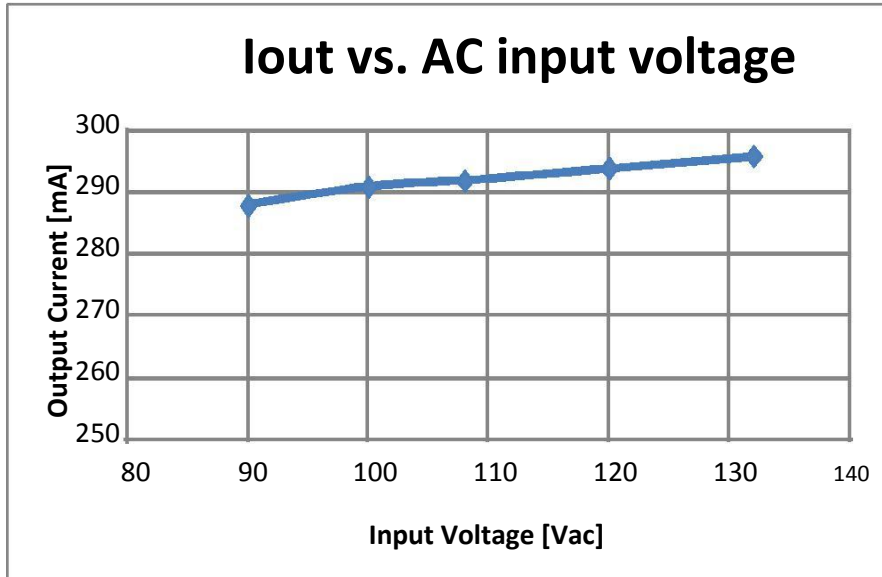

Figure 9 Output current vs. input voltage

Figure 10 shows the LED driver system's output current versus output voltage (LED module's forward voltage). With the number of LED changes from 11 to 13, which corresponds to forward voltage of 34.2V to 40.4V, the output current is regulated within +/-2%.

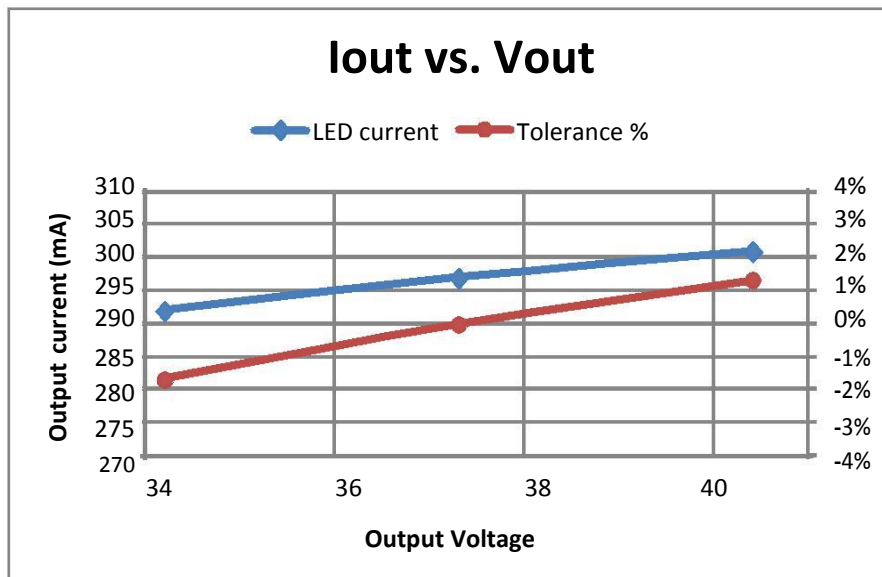

Figure 10 Output current vs. output voltage

9.8 Phase Cut Dimming

9.8.1 Test set-up

When evaluating dimming performance, the phase cut dimmer should be connected according to the arrangement as shown in [Figure 11](#).

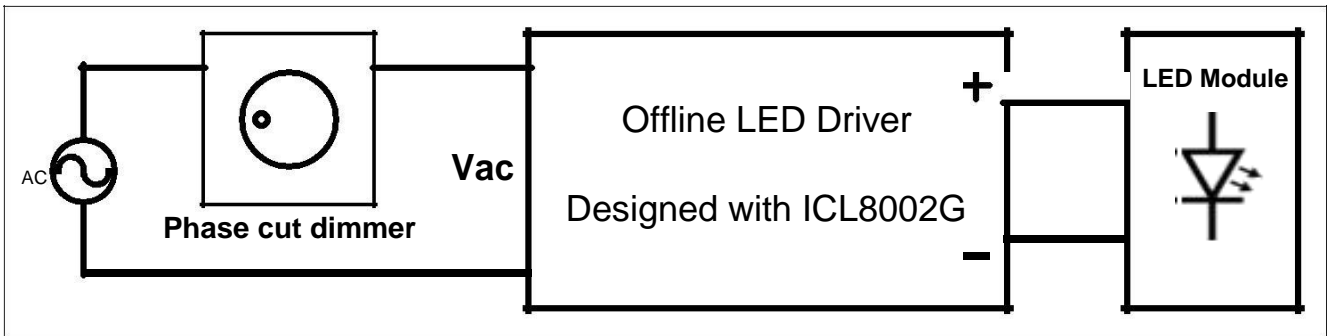

Figure 11 Phase cut dimming arrangement

9.8.2 Waveforms during dimming

[Figure 12](#) shows the waveforms of input voltage, input current, and the LED module's current when the LED driver is operated with a leading edge phase cut dimmer.

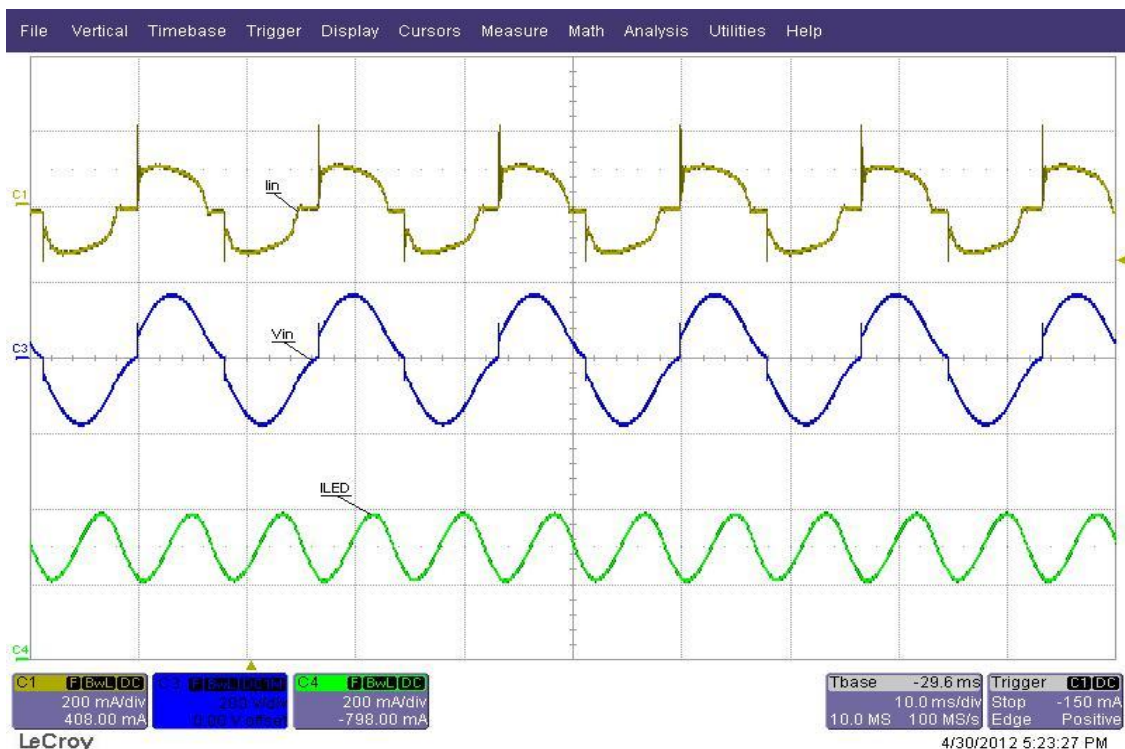

Figure 12 Waveforms during dimming operation: Input voltage V_{in} (C2, blue), Input current I_{in} (C1, yellow) and LED current (C4, green)

9.8.3 List of compatible TRIAC dimmers

A variety of TRIAC dimmers were tested with this demo board. These dimmers were chosen based on recommendations from customers and dimmer manufacturers. The table below lists the dimmers that exhibit no flickering and shimmering when tested with the demo board.

Table 2 Compatible dimmers tested at input 120 Vac / 10 W

Manufacturer	Model	Power limit	Dimming range
Leviton	RPI06-1LW	600 W	7 – 100 %
Leviton	6684	600 W	6 – 100 %
Leviton	SureSlide 6633	600 W	5 – 100 %
Lutron	TT-300H-WH	300W	10 – 100 %
Lutron	DVCL-153P-WH	600 W	6 – 100 %
Lutron	SKYLARK S-600-WH	600 W	6 – 100 %
Lutron	D-600PH-DK	600 W	10 – 100 %
Lutron	LXLV-600PL-WH	450 W	5 – 100 %
Lutron	S-603PG-WH	600 W	8 – 100 %
Lutron	Ariadni/Toggler AY-600P	600 W	8 – 100 %
Lutron	Vareo V-600	600 W	15 – 100 %
Lutron	NT-600	600 W	10 – 100 %
GE	DI61ULM5	600 W	10 – 100 %

9.9 System Efficiency

Figure 13 shows the LED driver system's efficiency versus line voltage, which exhibits high efficiency (>85%) over the whole input voltage range due to the quasi-resonant operation.

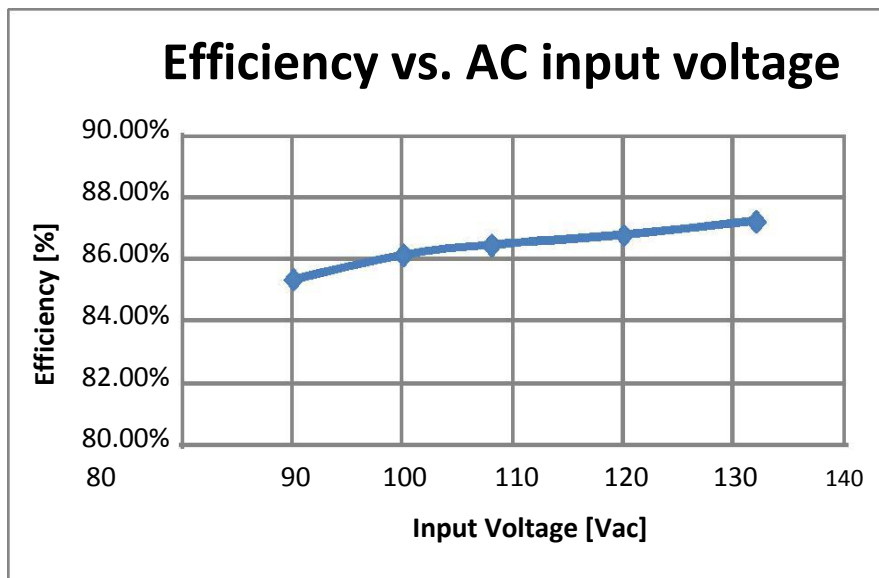

Figure 13 LED driver efficiency vs. input voltage

9.10 Protection Functions

The protection functions listed in [Table 3](#) are provided with ICL8002G.

Table 3 ICL8002G protection functions

VCC Overvoltage	Auto Restart Mode
VCC Undervoltage	Auto Restart Mode
Output Overvoltage	Latched Off Mode
Output Short Circuit	Auto Restart Mode
Short Winding	Latched Off Mode
Over temperature	Auto Restart Mode

9.10.1 Output Open Circuit Protection

When output is left open (not connecting to LED load) during operation, the output voltage will rise and accordingly the voltage produced by the auxiliary winding when MOSFET turns off will increase. This voltage is detected by ZCV pin of ICL8002G via R7 and R12 . Output overvoltage protection will be triggered once this voltage reaches the OVP threshold ($V_{zcovp} = 3.7\text{ V}$) and IC will go into Latched Off Mode. The power consumption during Latched Off Mode is kept below 0.3W.

The output voltage can reach 43V and therefore, it is advised to connect proper LED loads before switching on the power. [Figure 14](#) shows some waveforms when powering up the LED driver with no load connected.

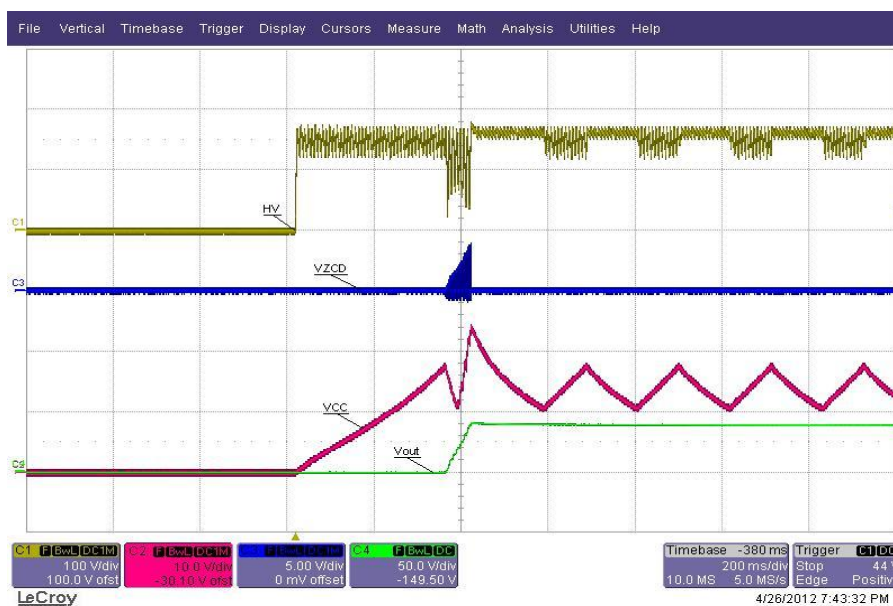

Figure 14 Waveforms during start-up without load: Input voltage at HV pin (C1, yellow), Vcc voltage (C2, red), ZCV signal (C3, blue), and output voltage (C4, green)

9.10.2 Output Short-circuit Protection

In the case of an output short circuit, the IC will switch to Auto Restart Mode by means of VCC undervoltage detection. Total input power consumption under this condition is below 0.7W. [Figure 15](#) shows the waveforms when powering up the LED driver with output short circuited.

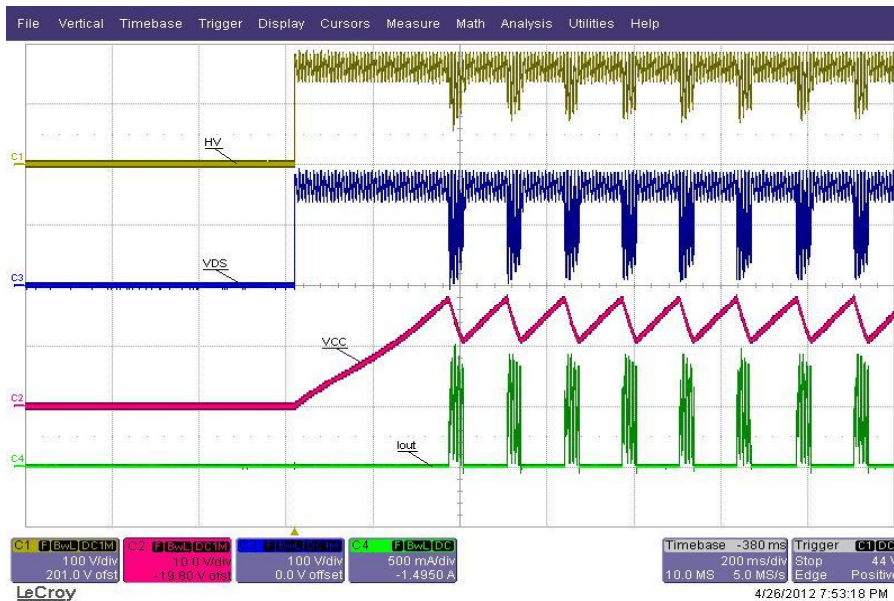

Figure 15 Waveforms during start-up with output short-circuited: Input voltage at HV pin (C1, yellow), Vcc voltage (C2, red), MOSFET drain voltage (C3, blue), and output current (C4, green)

9.11 Conducted EMI

The conducted EMI test is performed at 120Vac with full load condition. The EMI's peak value is plotted against quasi-peak limit of the FCC Class B and EN55015 (CISPR15). There is approximately 6dB margin observed.

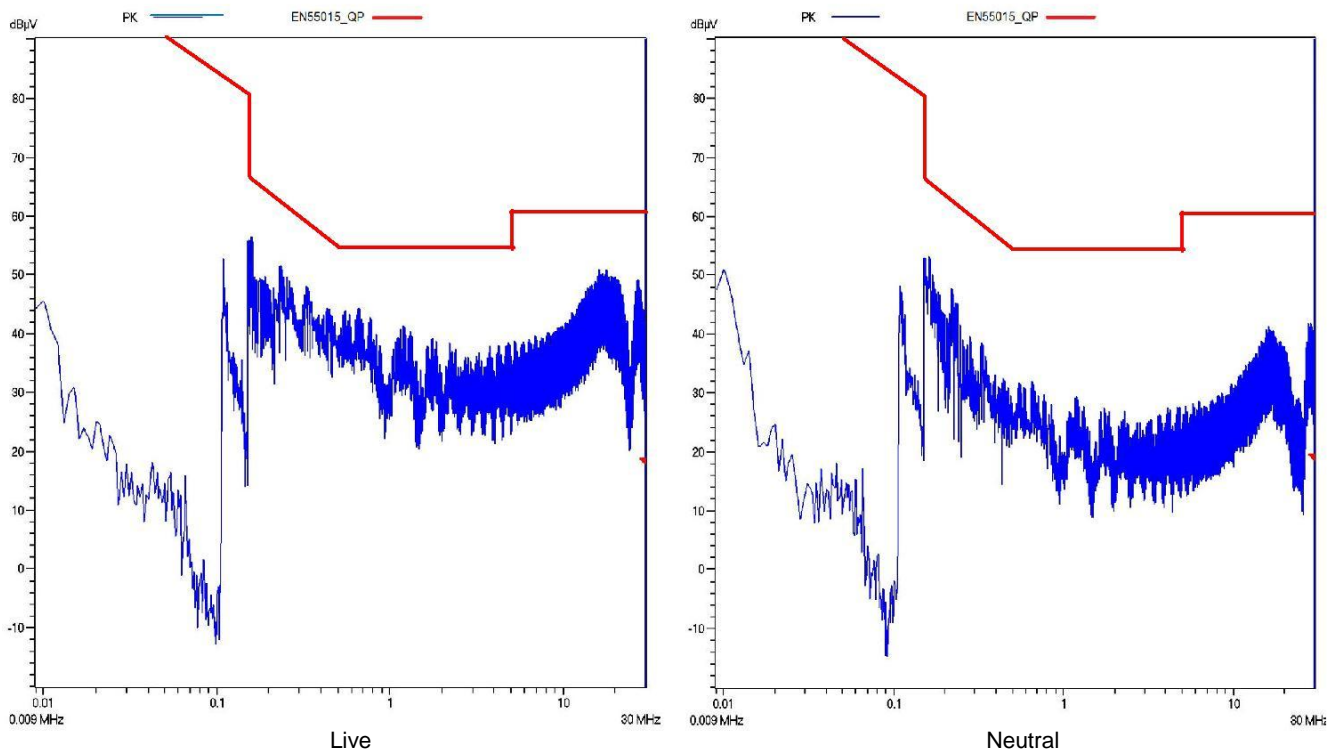

Figure 16 Tested at 120Vac with full load. EN55015 Class B limit.

10 Production Tolerance and Normal Distribution

In total 47 demo board samples have been tested and the output current of each board was recorded at the same test condition (line voltage of 120Vac and ambient temperature of 25°C) to check the production tolerance, which is contributed by both the IC and external components tolerance. **Figure 17** shows the distribution data of output current.

The result indicated that the output current tolerance is within $\pm 3\%$, and standard deviation is 3.62mA.

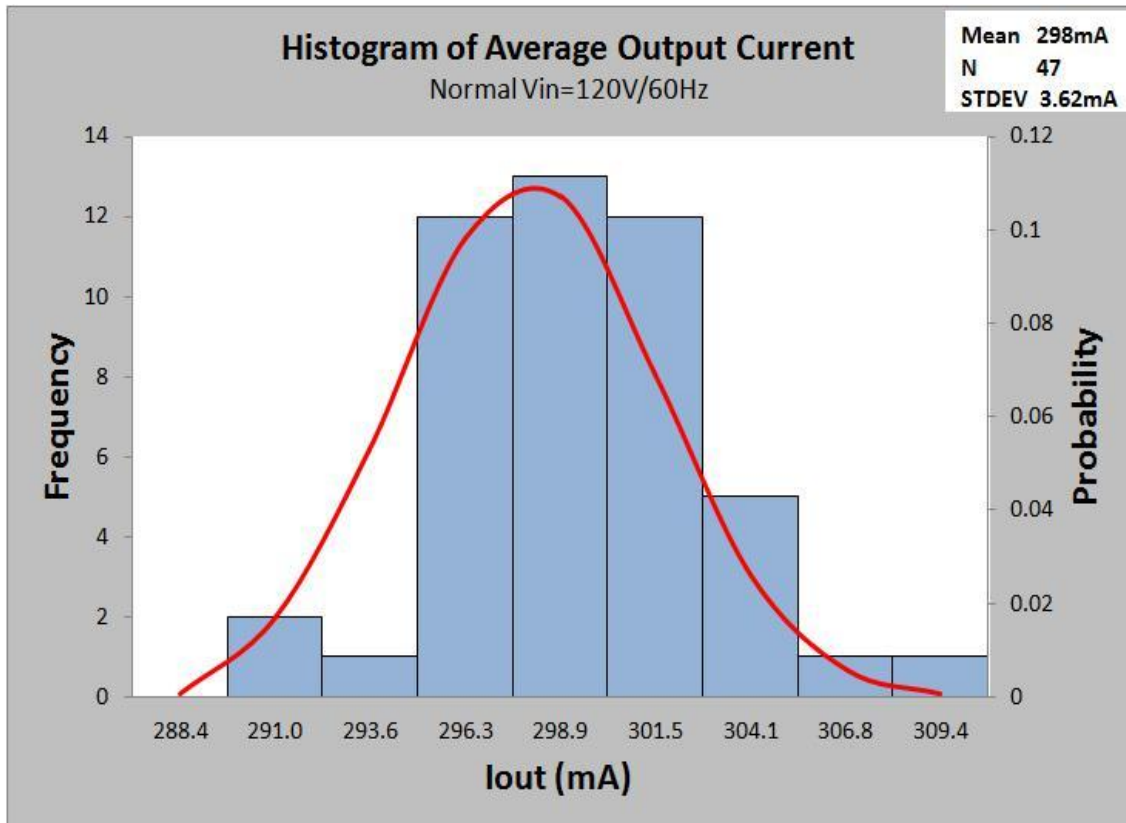

Figure 17 Production variation of output current (board to board deviation)

11 Board Layout

A single layer PCB with dimension of 40x20mm and thickness of 0.8mm is used for this demo board. The maximum height of the demo board (at C9) is 23.2mm. With its compact form factor, this demo board is able to fit into many different LED lamps such as A19 bulb and Par30.

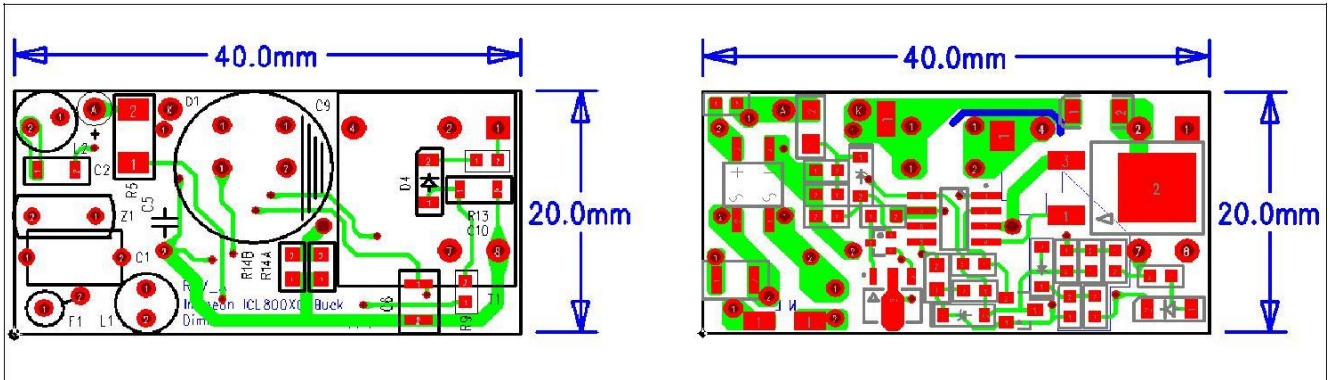

Figure 18 EVALLED-ICL8002G-B2 - Top and Bottom Layer

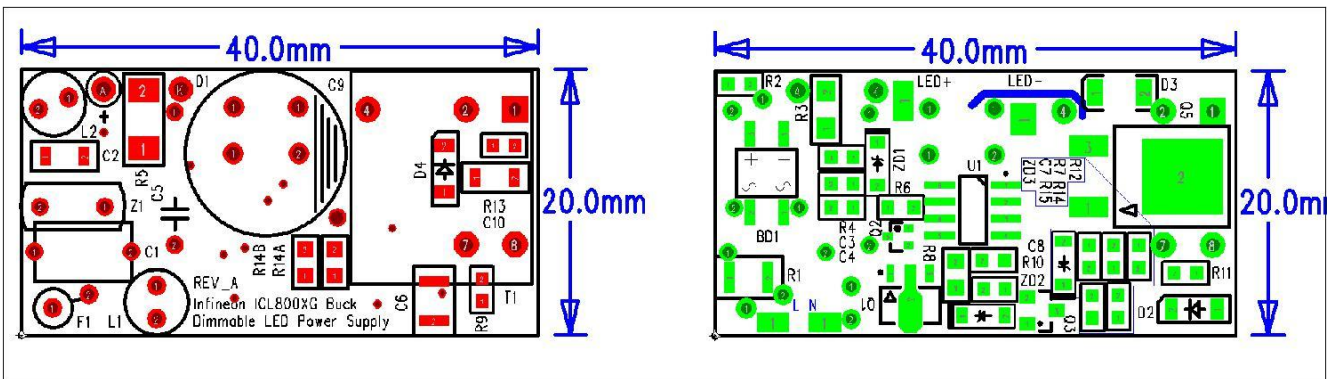

Figure 19 EVALLED-ICL8002G-B2 - Silkscreen Top and Bottom

12 BOM and Power Inductor Spec

12.1 Bill of Material

						
Number	Reference	Value	Description	Package	Part Number	Manufacturer
1	U1	ICL8002G	IC	SO8	ICL8002G	INFINEON
2	F1	220HM,2W	Fusible Resistor,±10%	4×10	EMC2-22RKI	WELWYN
3	Z1	360V	VARISTOR,13.5J, 140Vrms	7mm Disc	V07E140P	LITTELFUSE
4	Q1	600V 0.09A	Small Signal Mosfet	SOT89	BSS225	INFINEON
5	Q2	45V 0.1A	NPN Transistors	SOT323	BC847BW	INFINEON
6	Q3	45V 0.1A	PNP Transistor	SOT23	BC857B	INFINEON
7	Q5	600V 2.4A	MOSFET	DKPAK	IPD60R2K0C6	INFINEON
8	C1	250V 0.22uF	Film Cap, 7.5mm Pitch	4.9×7.5×9.0	B32560J3224	TDK-EPCOS
9	C2	15nF 630V	MLCC,X7R	1206	GRM31CR72J153KW03L	MURATA
10	C4	50V 1nF	MLCC,X7R	0603	GRM188R71H102KA01D	MURATA
11	C5	250V 0.22uF	Film Cap, 10mm Pitch	12×5.5×10.5	ECQ-E2224JF	PANASONIC
12	C6	25V 22uF	MLCC,X7R	1210	GRM32ER71E226KE15L	MURATA
13	C7	50V 56pF	MLCC,COG	0603	GRM1885C1H560JA01D	MURATA
14	C8	50V 10nF	MLCC,X7R	0603	GRM188R71H103KA01D	MURATA
15	C9	50V 330UF	Electrolytic Cap,Lo=10000H	10×20	50ZLH330MT810X20	RUBYCON
16	C10	50V 4.7uF	MLCC,X7R	1206	GRM31CR71H475KA12L	MURATA
17	D1	400V 1A	Ultrafast Rectifier Diode	DO-41	UF4004	VISHAY
18	D2,D4	150V 250mA	Switching Diode	SOD80C	BAV102	NXP
19	D3	600V 1.5A	Ultrafast Rectifier Diode	SMA	BYG20J	VISHAY
20	T1	210uH	Coupled inductor,210uH±10% Np:Nvcc:Naux = 70:40:11	EE13	750341383	Würth Elektronik
21	L1,L2	1.5mH 0.19A	Filter Choke		7447462152	Würth Elektronik
22	BD1	600V 0.5A	Bridge Diode	TO-269AA	MB6S-E3/80	VISHAY
23	ZD1	11V	Zener Diode,500mW	SOD123	MMSZ5241B-V-GS08	VISHAY
24	ZD2	4.7V	Zener Diode,500mW	SOD123	MMSZ4688-V-GS08	VISHAY
25	ZD3	15V	Zener Diode,400mW	SOD323	PDZ15B,115	NXP
26	R1	1K 1/2W	Metal Film Resistor,5%	1210		
27	R2	4K7	Metal Film Resistor,5%	0603		
28	R3	1.5M	Metal Film Resistor,5%	1206		
29	R4	604K	Metal Film Resistor,5%	0603		
30	R5	3.6K 3/4W	Metal Film Resistor,5%	2010		
31	R6,R15	121K	Metal Film Resistor,1%	0603		
32	R7	3.48K	Metal Film Resistor,1%	0603		
33	R8	576K	Metal Film Resistor,1%	0805		
34	R9	118K	Metal Film Resistor,1%	0603		
35	R10	12K7	Metal Film Resistor,1%	0603		
36	R11	0R	Metal Film Resistor,5%	0603		
37	R12	20K	Metal Film Resistor,1%	0603		
38	R13	10R	Metal Film Resistor,5%	0603		
39	R14	33K	Metal Film Resistor,5%	0603		
40	R14A	1R	Metal Film Resistor,1%	0805		
41	R14B	1R5	Metal Film Resistor,1%	0805		

Figure 20 Bill Of Material

12.2 Power Inductor

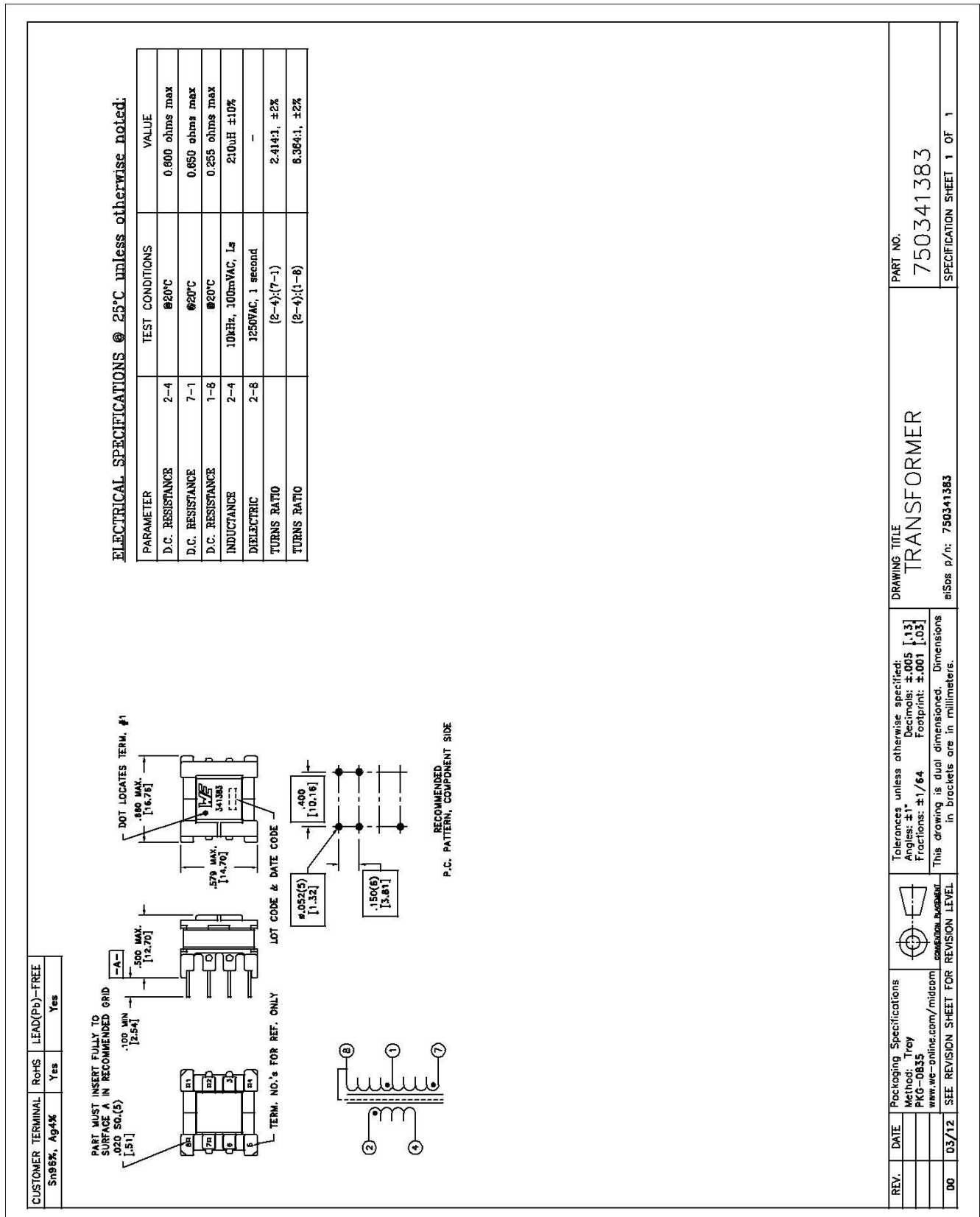

Figure 21 EVALLED-ICL8002G-B2 Inductor Design

13 Common Questions and Troubleshooting Hints

13.1 Q&A

How does ICL8002G realize dimming control and power factor correction?

Both dimming control and PFC are achieved with the input mains voltage sensing with the VR pin. This signal is used to set the peak current of the primary winding and consequently allows both PFC and phase-cut dimming functionality by regulating the cycle energy.

Is it possible to test the demo board with different LED modules with big variations in total forward voltages?

The operation range of output voltage is specified in [Table 1](#). The demo board will switch into protection mode when tested with LED load with out-of-range forward voltage either due to Vcc overvoltage protection or Vcc undervoltage protection. Modifications on the transformer design are necessary for applications with different output voltage.

13.2 Design and Troubleshooting Hints

Why is there no light output after the LED load is connected and power is on?

Please verify the following:

- Connectivity of AC input and LED load
- LED module's polarity
- Whether LED module's forward voltage is out of the range specified in [Table 1](#)

How to change output current?

The easiest way to set the desired output current is to adjust the VR pin's voltage and shunt resistor. However, care must be taken to ensure that the transformer is not driven into saturation. Moreover, the VR pin's voltage should be kept below 3.7V for maximum power factor.

How to change the open circuit protection to Auto Restart Mode?

If Auto Restart Mode is preferred for output open circuit protection, R7 and/or R12 can be adjusted so that Vcc overvoltage threshold ($V_{vccovp} = 25V$) is reached first before OVP threshold ($V_{zcovp} = 3.7 V$) is reached. Please note that with changing R12, the voltage foldback correction will be affected and as a result the line regulation will be affected. In this case R9 can be tuned for better line regulation.

Why is the LED flickering in my dimming application? How to improve?

Flickering can be either caused by IC auto-restart or by dimmer's uneven conduction phase angle. For the auto-restart case, the ICL8002G's Vcc voltage should be maintained between V_{vccovp} and V_{vccoff} over the whole dimming range. This can be achieved by proper transformer turn ratio design and, if necessary, a voltage regulation circuit for the Vcc. For dimmer's uneven conduction case, it is advised to tune the damping and bleeder circuits.

How to improve system efficiency?

For applications which require higher efficiency, first of all, an active damper circuit can be used to replace the lossy passive damper circuit. Switching frequency can be reduced so as to minimize the switching loss and this may require bigger inductor size. Low ESR capacitor can be used for the output capacitor to improve efficiency. Using a higher current rated MOSFET for Q5, however, may not necessarily produce higher efficiency as the switching loss may dominate the total power loss of the MOSFET.

How to modify the board for non-dimmable LED bulb application?

For non-dimmable application, the highlighted damping and bleeder circuits as shown in [Figure 2](#) can be removed for better efficiency and cost reduction.

How to reduce BOM cost?

For low cost application, the active bleeder circuit (formed by R3-R6, C3, C4, ZD1, Q1, and Q2) can be removed. Please note that dimming performance may be affected. If lightning surge performance requirement is not stringent, a 250V rated MOSFET can be used for Q2 while a 500V rated MOSFET can be used for Q5 for cost reduction.

14 References

[ICL8002G Datasheet](http://www.infineon.com/ledoffline) at www.infineon.com/ledoffline

[Design Guidelines for ICL8001G/ICLS8082G](http://www.infineon.com/ledoffline) at www.infineon.com/ledoffline

www.infineon.com

Published by Infineon Technologies AG