

LTC3892-2, 60V, Low I_Q Multiphase Synchronous Step-Down Converter

DESCRIPTION

Demonstration circuit 2493A is a high output voltage capable, high efficiency synchronous PolyPhase[®] buck converter featuring the LTC[®]3892EUH-2. The DC2493A has a wide input voltage range from 16V to 55V, and is capable of delivering up to 30A of output current. The output voltage of the DC2493A is set to 12V, however, the output voltage can go as high as 55V, with certain modifications. The DC2493A supports three operation modes: fixed-frequency modulation, pulse-skipping mode and Burst Mode[®] operation. Fixed-frequency mode of operation reduces output voltage ripple, and yields a low noise switching spectrum. Burst Mode operation employs a variable frequency switching algorithm that minimizes the input quiescent current and improves efficiency at light loads.

The DC2493A consumes less than 5 μ A of quiescent current during shutdown and it consumes less than 1mA at a no load condition in Burst Mode operation. The DC2493A has a standard operating frequency of 150kHz, but can be adjusted to frequencies as high as 900kHz. The DC2493 is a dual phase step-down converter; however it designed to be easily transformed to a 4- or 6-phase system by combining two or three DC2493A boards. The LTC3892-2 data sheet gives a complete description of these parts, operation, and application information and must be read in conjunction with this quick start guide for demonstration circuit 2493A.

Design files for this circuit board are available at <http://www.linear.com/demo/DC2493A>

LT, LT, LTC, LTM, Linear Technology, PolyPhase, Burst Mode and the Linear logo are registered trademarks of Linear Technology Corporation. All other trademarks are the property of their respective owners.

PERFORMANCE SUMMARY Specifications are at T_A = 25°C

PARAMETER	CONDITIONS	VALUE	UNITS
Minimum Input Voltage		16	V
Maximum Input Voltage		55	V
Output Voltage V _{OUT} Regulation	V _{IN} = 16V – 55V	12 \pm 2%	V
Maximum Continuous Output Current		30	A
Preset Operating Frequency	R_PRG = 31.6k Ω	150	kHz
External Clock Sync Frequency Range		75 to 850	kHz
Efficiency	V _{IN} = 24V, V _{OUT} = 12V, I _{OUT} = 15A See Figures 3, 4 Efficiency Curves for Complete Operating Range	97	%
Typical Output Ripple V _{OUT}	V _{IN} = 36V, I _{OUT} = 15A (20MHz BW)	< 35	mV _{P-P}
Quiescent Current at Shut-Down	V _{IN} = 16V – 55V	< 7	μ A
Input Current at No Load	V _{IN} = 16V – 55V	< 100	μ A

QUICK START PROCEDURE

Demonstration circuit 2493A is easy to set up to evaluate the performance of the [LTC3892-2](#). For proper measurement equipment configuration, set up the circuit according to the diagram in Figure 1. Before proceeding to test, insert shunt JP2 (RUN) into OFF position, which connects the RUN pin to ground (GND), and thus, shut-down the circuit.

NOTE: When measuring the input or output voltage ripple, care must be taken to avoid a long ground lead on the oscilloscope probe. Measure the input or output voltage ripple by touching the probe tip directly across the V_{IN} or V_{OUT} and GND terminals. See Figure 2 for proper scope probe technique.

1. With the DC2394 set up according to the proper measurement and equipment in Figure 1, apply 20V at V_{IN} . Measure V_{OUT} ; it should read 0V. If desired, one can measure the shutdown supply current at this point. The supply current will be approximately $5\mu A$, or less, in shutdown.

2. Turn on the circuit by inserting the shunt in header JP2 (RUN) into the ON position. The output voltage should be regulating. Measure V_{OUT} — it should measure $12V \pm 2\%$ (Do not apply more than the rated maximum voltage of 55V to the board or the part may be damaged).
3. Vary the converter load, which should not exceed 30A. Note: all four input and output terminals V_{IN} , V_{OUT} and two GND equipped with two banana jacks, two-wires can be used for each terminal to reduce copper losses and heat dissipation in the interconnection lines.
4. Vary the input voltage from 16V to 55V; V_{OUT} should measure $12V \pm 2\%$.
5. Set output current to zero and move jumper JP1 (MODE) into Burst Mode position and measure V_{OUT} ; it should register $12V \pm 2\%$.
6. Set output current to zero and move jumper JP2 (MODE) into PLS SKIP position and measure V_{OUT} ; it should register $12V \pm 2\%$.

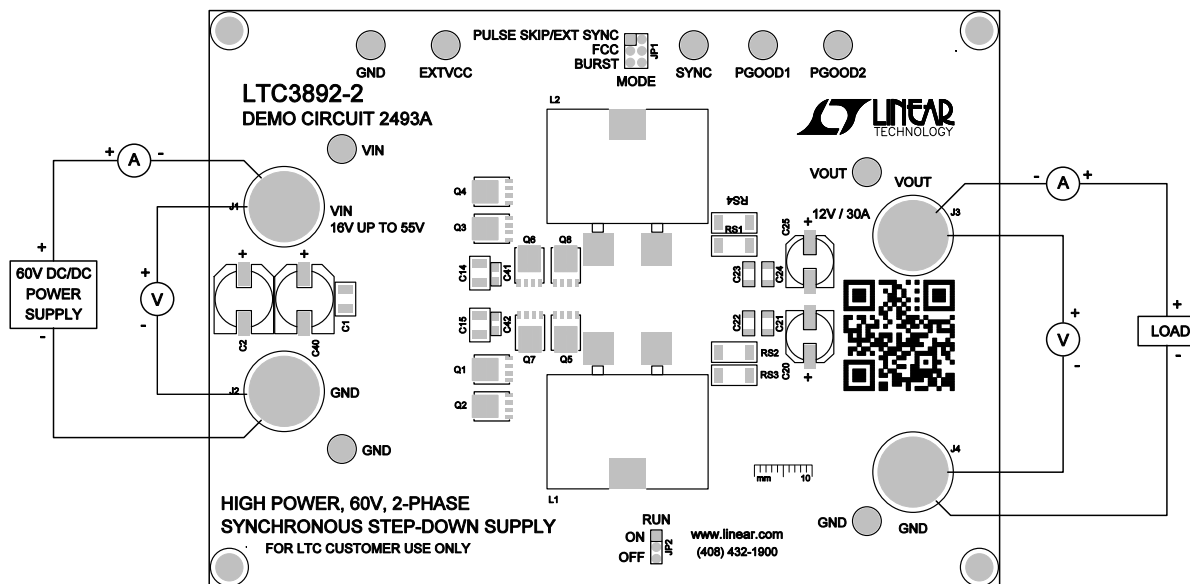

Figure 1. Proper Measurement Equipment Setup

QUICK START PROCEDURE

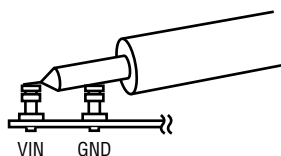

Figure 2. Measuring Input or Output Ripple

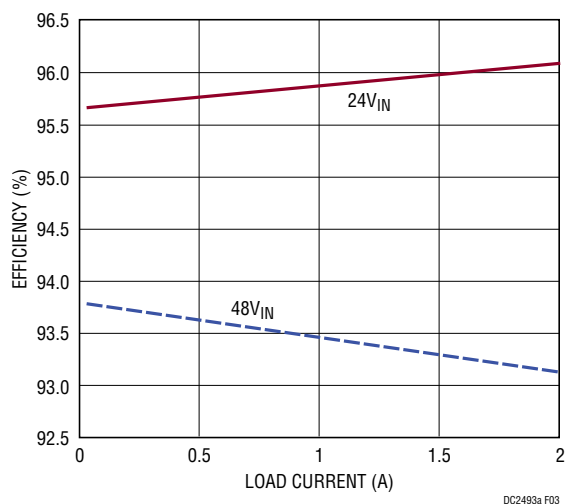

Figure 3. Efficiency vs Load Current, Light Loads

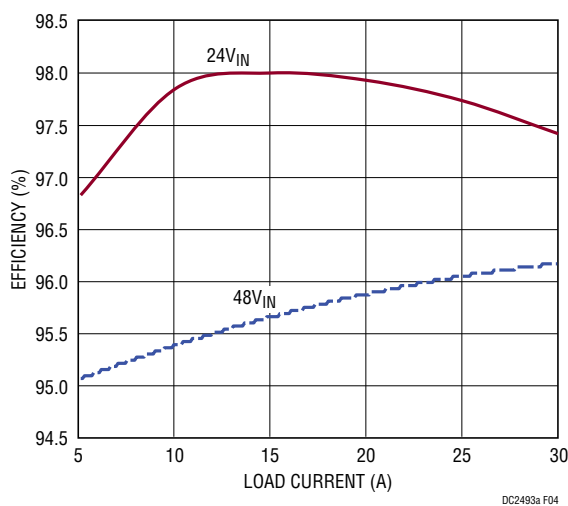

Figure 4. Efficiency vs Load Current

QUICK START PROCEDURE

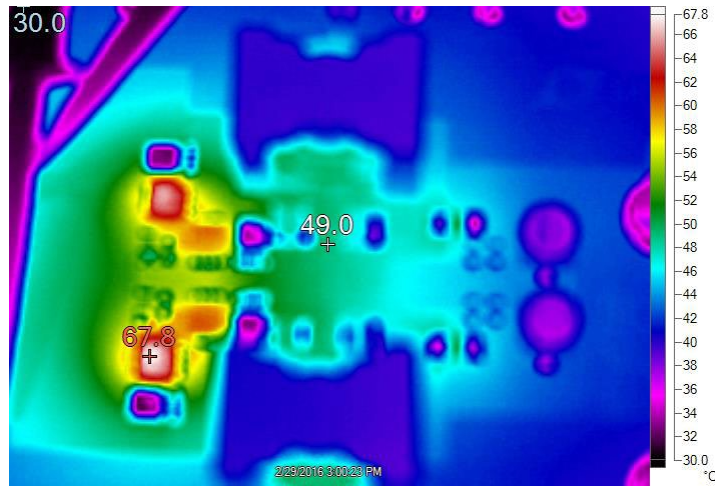

Figure 5. Thermal Map, V_{IN} 24V, I_O 30A, No Air Flow, $T_A = 25^\circ\text{C}$

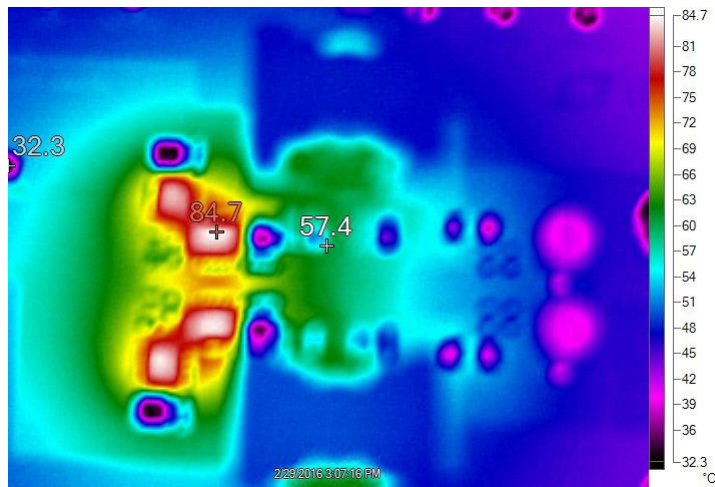

Figure 6. Thermal Map, V_{IN} 48V, I_O 30A, No Air Flow, $T_A = 25^\circ\text{C}$

PARTS LIST

ITEM	QTY	REFERENCE	PART DESCRIPTION	MANUFACTURER/PART NUMBER
Required Circuit Components				
1	5	C1, C14, C15, C16, C17	CAP, 1210 2.2µF 10% 100V X7R	MURATA GRM32ER72A225KA35
2	1	C2	CAP, 56µF 20% 63V HYBRID ALUM ELEC	PANASONIC EEHA1J560P
3	2	C3, C33	CAP, 0805 0.1µF 10% 100V X7R	MURATA GRM21BR72A104KAC4L
4	2	C4, C51	CAP, 0805 2.2µF 10% 25V X7R	MURATA GRM21BR71E225KA73L
5	1	C5	CAP, 0603 0.1µF 10% 50V X7R	MURATA GRM188R71H104KA93D
6	2	C6, C8	CAP, 0603 47pF 5% 100V NPO	MURATA GRM1885C2A470JA01D
7	1	C7	CAP, 0603 10pF 5% 50V C0G	MURATA GRM1885C1H100JA01D
8	1	C9	CAP, 0603 6.8nF 10% 50V X7R	MURATA GRM188R71H682KA01D
9	1	C11	CAP, 0603 0.1µF 10% 100V X7R	MURATA GRM188R72A104KA35D
10	2	C12, C13	CAP, 0603 220pF 5% 100V C0G	MURATA GRM1885C2A221JA01D
11	2	C18, C27	CAP, 0603 1µF 10% 16V X7R	MURATA GRM188R71C105KA12D
12	2	C20, C25	CAP, 150µF 20% 16V ALUM	PANASONIC 16SVPC150M
13	4	C21, C22, C23, C24	CAP, 1206 10µF 10% 16V X7R	MURATA GRM31CR71C106KAC7L
14	2	C30, C31	CAP, 0603 0.22µF 10% 25V X5R	MURATA GRM188R61E224KA88D
15	4	C41, C42, C43, C44	CAP, 0805 0.1µF 10% 100V X7R OPT	MURATA GRM21BR72A104KAC4L OPT
16	2	L1, L2	IND, 6.8µH	COILCRAFT SER2918H-682KL
17	2	Q1, Q3	XSTR, MOSFET N-CH 80V 49A TDSO8	INFINEON BSC117N08NS5
18	2	Q6, Q7	XSTR, MOSFET N-CH 80V 100A TDSO8	INFINEON BSC026N08NS5
19	2	RS1, RS2	RES, 2010 0.001Ω 1% 1W	VISHAY WSL20101L000FEA18
20	1	R_PRG	RES, 0603 31.6kΩ 1% 1/10W	VISHAY CRCW060331K6FKEA
21	1	R1	RES, 1206 2.2Ω 1% 1/4W	VISHAY CRCW12062R20FKEA
22	10	R3, R7, R10, R12, R16, R17, R18, R27, R28, R36	RES, 0603 0Ω JUMPER	VISHAY CRCW06030000Z0EA
23	3	R8, R31, R32	RES, 0603 100kΩ 5% 1/10W	VISHAY CRCW0603100KJNEA
24	1	R9	RES, 0805 499kΩ 1% 1/8W	VISHAY CRCW0805499KFKEA
25	1	R11	RES, 0603 35.7kΩ 1% 1/10W	VISHAY CRCW060335K7FKEA
26	1	R14	RES, 0603 9.76kΩ 1% 1/10W	VISHAY CRCW06039K76FKEA
27	2	R19, R20	RES, 0603 100Ω 5% 1/10W	VISHAY, CRCW0603100RJNEA
28	1	R30	RES, 0603 90.9kΩ 1% 1/10W	VISHAY CRCW060390K9FKEA
29	1	U1	IC, DUAL OUTPUT HIGH VOLTAGE STEP-DOWN CONVERTER	LINEAR TECHNOLOGY LTC3892EUH-2#PBF
Additional Demo Board Circuit Components				
31	5	C28, C29, C32, C34, C35	CAP, 0603 OPTION	OPTION
32	4	C45, C46, C48, C50	CAP, 1206 OPTION	OPTION
33	3	C40, C47, C49	CAP, ELEC OPTION	OPTION
34	4	Q2, Q4, Q5, Q8	XSTR, OPTION	OPTION
35	2	RS3, RS4	RES, 2010 OPTION	OPTION
36	7	R2, R4, R5, R13, R21, R22, R23	RES, 0603 OPTION	OPTION
37	6	R24, R25, R26, R29, R33, R34,	RES, 0603 OPTION	OPTION
38	2	R46, R83	RES, 0603 OPTION	OPTION

DEMO MANUAL DC2493A

PARTS LIST

ITEM	QTY	REFERENCE	PART DESCRIPTION	MANUFACTURER/PART NUMBER
Hardware: For Demo Board Only				
39	9	E1, E2, E4, E5, E6, E7, E8, E9, E10	TURRET	MIIL-MAX 2501-2-00-80-00-00-07-0
40	5		LUG RING, #10	KEYSTONE 8205
41	10		NUT, BRASS 10-32	ANY #10-32
42	1	JP1	HEADER, 3PIN, DBL ROW 2mm	SULLINS, NRPN032PAEN-RC
43	1	JP2	HEADER, 2mm, 3PIN	SULLINS, NRPN031PAEN-RC
44	5		WASHER, #10 TIN PLATED BRASS	ANY #10 EXT BZ TN
45	4	J1, J2, J3, J4	STUD, TESTPIN	PEM KFH-032-10
46	2	XJP1, XJP2	SHUNT, 2mm	

SCHEMATIC DIAGRAM

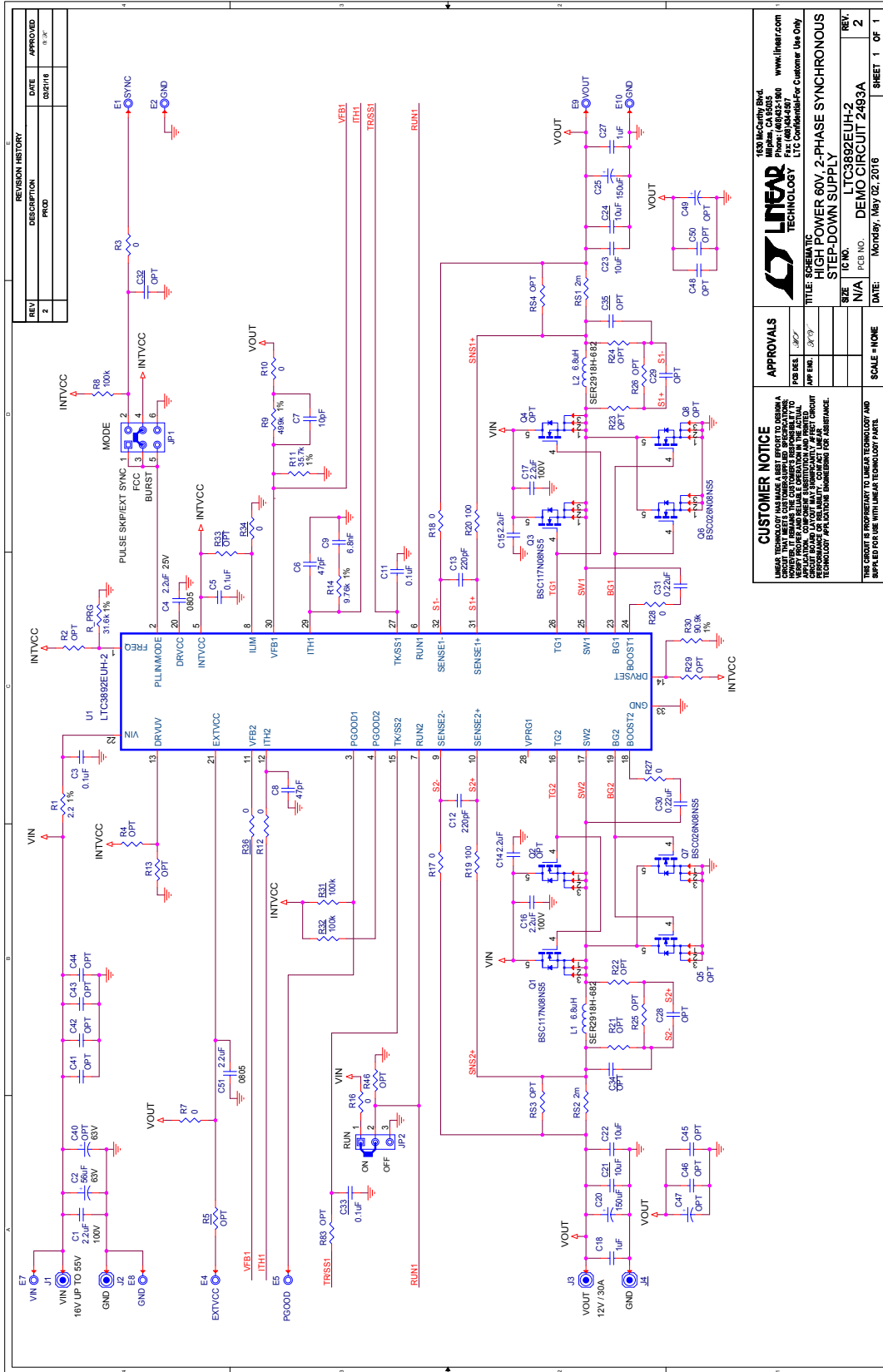

REVISION HISTORY		
REV	DESCRIPTION	DATE
2		02/01/16
1		03/27

CUSTOMER NOTICE
 LINEAR TECHNOLOGY HAS MADE A BEST EFFORT TO DESIGN A SCHEMATIC THAT REPRESENTS THE INTENDED OPERATION OF THE CIRCUIT. HOWEVER, IT REMAINS THE CUSTOMER'S RESPONSIBILITY TO VERIFY THE SCHEMATIC REPRESENTS THE ACTUAL OPERATION OF THE CIRCUIT. LINEAR TECHNOLOGY ACCEPTS NO LIABILITY FOR ANY DAMAGE TO PROPERTY OR PERSONS ARISING FROM THE USE OF THIS SCHEMATIC FOR ANY PURPOSE OTHER THAN AS A REFERENCE. CONTACT YOUR SALES REPRESENTATIVE FOR FURTHER INFORMATION.

APPROVALS
 FOR USE: [Signature]
 DATE: [Date]

LINEAR TECHNOLOGY
 1600 McCarthy Blvd.
 Milpitas, CA 95035-5080
 Phone: (408)432-3900
 Fax: (408)432-3997
 www.linear.com

TITLE: SCHEMATIC
STEP-DOWN SUPPLY
HIGH POWER 60V, 2-PHASE SYNCHRONOUS

IC NO.: LTC3922EUH-2
PCB NO.: DEMO-CIRCUIT 2493A
REV.: 2

DATE: Monday, May 02, 2016
SCALE: NONE
SHEET: 1 OF 1



Information furnished by Linear Technology Corporation is believed to be accurate and reliable. However, no responsibility is assumed for its use. Linear Technology Corporation makes no representation that the interconnection of its circuits as described herein will not infringe on existing patent rights.

DEMO MANUAL DC2493A

DEMONSTRATION BOARD IMPORTANT NOTICE

Linear Technology Corporation (LTC) provides the enclosed product(s) under the following **AS IS** conditions:

This demonstration board (DEMO BOARD) kit being sold or provided by Linear Technology is intended for use for **ENGINEERING DEVELOPMENT OR EVALUATION PURPOSES ONLY** and is not provided by LTC for commercial use. As such, the DEMO BOARD herein may not be complete in terms of required design-, marketing-, and/or manufacturing-related protective considerations, including but not limited to product safety measures typically found in finished commercial goods. As a prototype, this product does not fall within the scope of the European Union directive on electromagnetic compatibility and therefore may or may not meet the technical requirements of the directive, or other regulations.

If this evaluation kit does not meet the specifications recited in the DEMO BOARD manual the kit may be returned within 30 days from the date of delivery for a full refund. **THE FOREGOING WARRANTY IS THE EXCLUSIVE WARRANTY MADE BY THE SELLER TO BUYER AND IS IN LIEU OF ALL OTHER WARRANTIES, EXPRESSED, IMPLIED, OR STATUTORY, INCLUDING ANY WARRANTY OF MERCHANTABILITY OR FITNESS FOR ANY PARTICULAR PURPOSE. EXCEPT TO THE EXTENT OF THIS INDEMNITY, NEITHER PARTY SHALL BE LIABLE TO THE OTHER FOR ANY INDIRECT, SPECIAL, INCIDENTAL, OR CONSEQUENTIAL DAMAGES.**

The user assumes all responsibility and liability for proper and safe handling of the goods. Further, the user releases LTC from all claims arising from the handling or use of the goods. Due to the open construction of the product, it is the user's responsibility to take any and all appropriate precautions with regard to electrostatic discharge. Also be aware that the products herein may not be regulatory compliant or agency certified (FCC, UL, CE, etc.).

No License is granted under any patent right or other intellectual property whatsoever. **LTC assumes no liability for applications assistance, customer product design, software performance, or infringement of patents or any other intellectual property rights of any kind.**

LTC currently services a variety of customers for products around the world, and therefore this transaction **is not exclusive**.

Please read the DEMO BOARD manual prior to handling the product. Persons handling this product must have electronics training and observe good laboratory practice standards. **Common sense is encouraged.**

This notice contains important safety information about temperatures and voltages. For further safety concerns, please contact a LTC application engineer.

Mailing Address:

Linear Technology
1630 McCarthy Blvd.
Milpitas, CA 95035

Copyright © 2004, Linear Technology Corporation