

Silicon Schottky Diode

Preliminary data

- For mixer applications in the VHF/UHF range
- For high speed switching

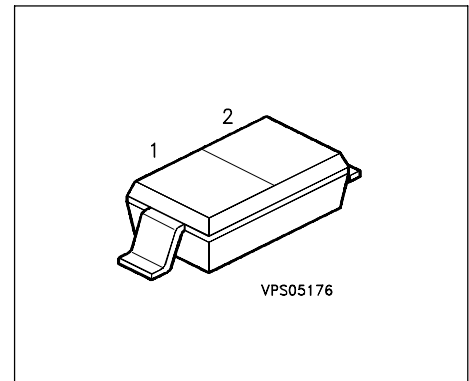

Type	Marking	Ordering Code	Pin Configuration			Package
BAT 68-03W	K	Q62702-A1046	1 = A	2 = K		SOD-323

Maximum Ratings

Parameter	Symbol	Values	Unit
Diode reverse voltage	V_R	8	V
Forward current	I_F	130	mA
Total Power dissipation $T_S = 95\text{ °C}$	P_{tot}	150	mW
Junction temperature	T_j	150	°C
Operating temperature range	T_{op}	- 65 ... + 150	
Storage temperature	T_{stg}	- 65 ... + 150	

Thermal Resistance

Junction ambient ¹⁾	R_{thJA}	445	K/W
Junction - soldering point	R_{thJS}	365	

Electrical Characteristics at $T_A=25^\circ\text{C}$, unless otherwise specified

Parameter	Symbol	Values			Unit
		min.	typ.	max.	
DC characteristics					
Breakdown voltage $I_{(BR)} = 10 \mu\text{A}$	$V_{(BR)}$	8	-	-	V
Reverse current $V_R = 1 \text{ V}, T_A = 25^\circ\text{C}$ $V_R = 1 \text{ V}, T_A = 60^\circ\text{C}$	I_R	-	-	0.1 1.2	μA
Forward voltage $I_F = 1 \text{ mA}$ $I_F = 10 \text{ mA}$	V_F	- 340	318 390	340 500	mV
Diode capacitance $V_R = 0, f = 1 \text{ MHz}$	C_T	-	-	1	pF
Differential forward resistance $I_F = 5 \text{ mA}$	R_F	-	-	10	Ω

Forward current $I_F = f(T_A^*; T_S)$

*) : mounted on alumina 15mm x 16.7mm x 0.7mm

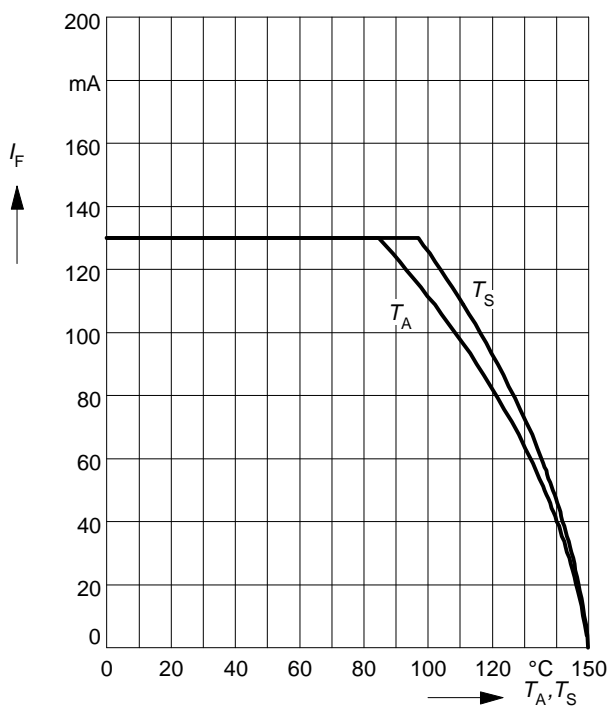

Permissible Pulse Load $R_{THJS} = f(t_p)$

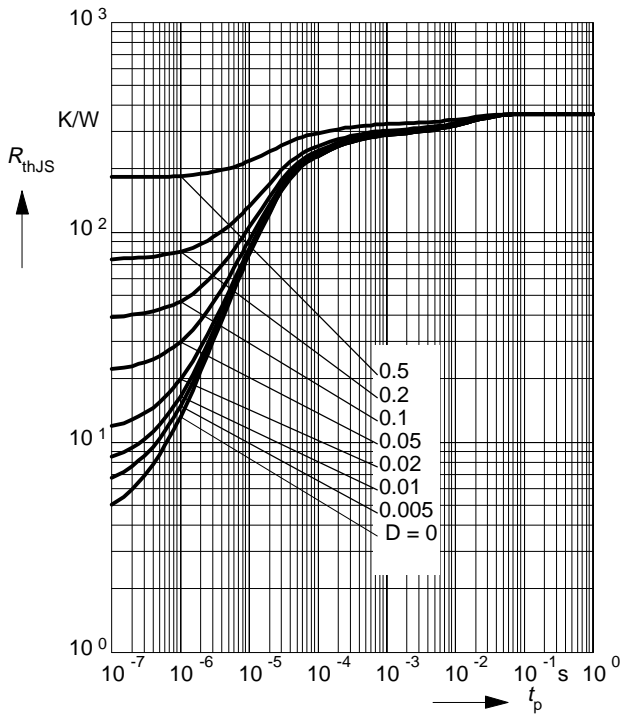

Permissible Pulse Load $I_{Fmax}/I_{FDC} = f(t_p)$

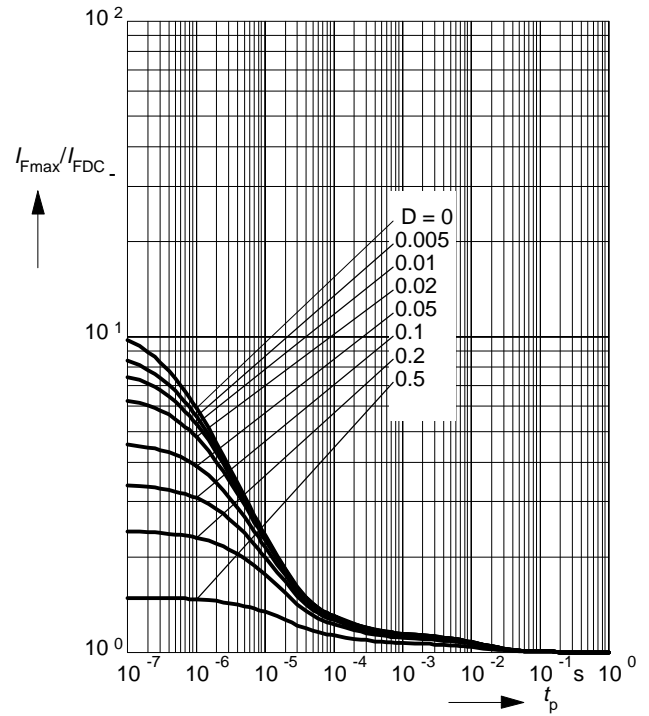

Forward Current $I_F = f(V_F)$

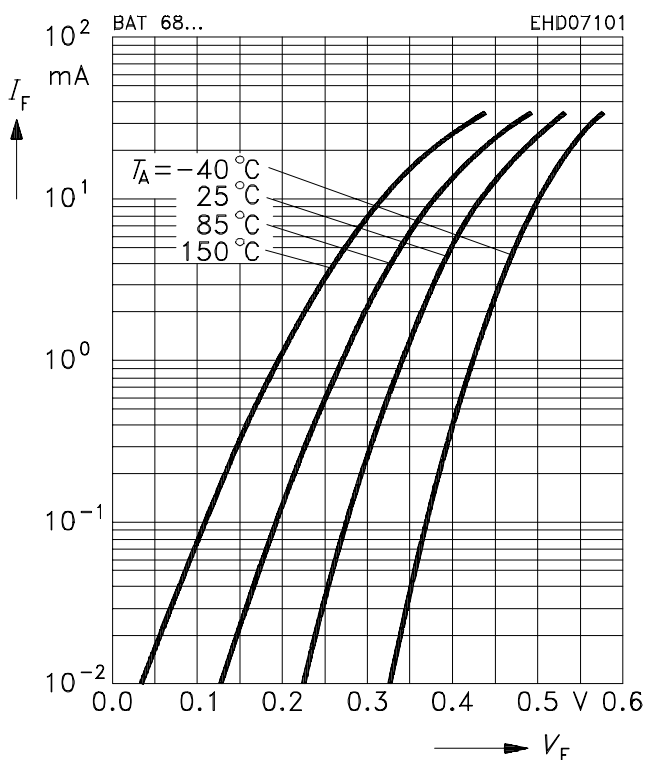

Reverse current $I_R = f(T_A)$

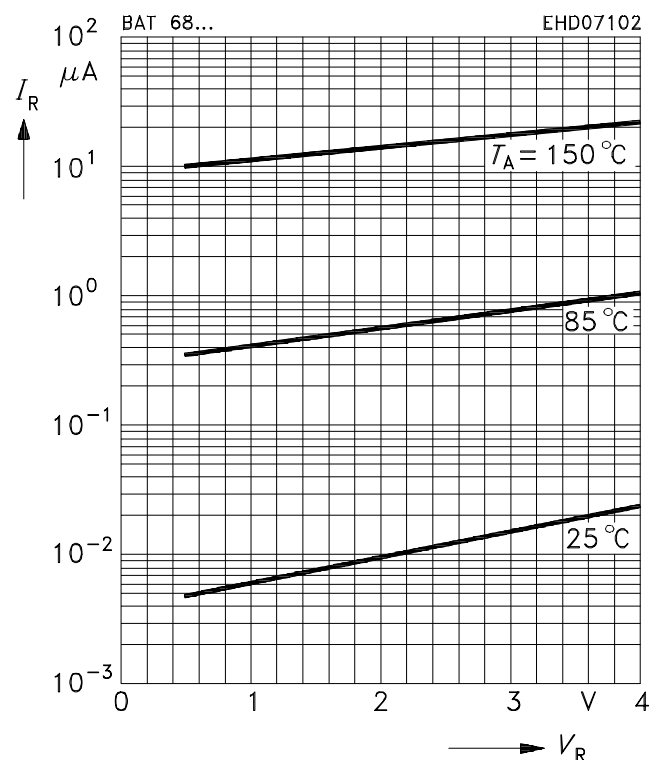

Diode capacitance $C_T = f(V_R)$
 $f = 1\text{MHz}$

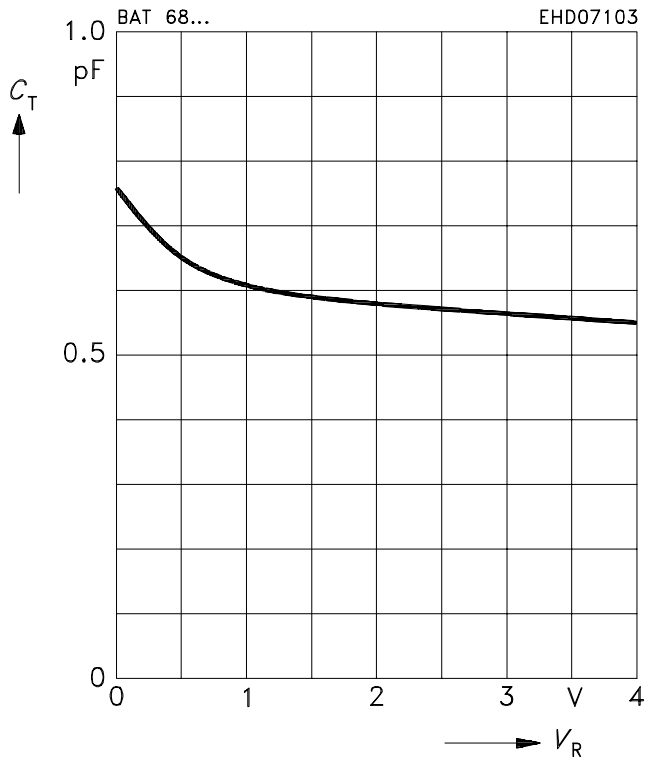

Differential forward resistance $r_f = f(I_F)$
 $f = 10\text{kHz}$

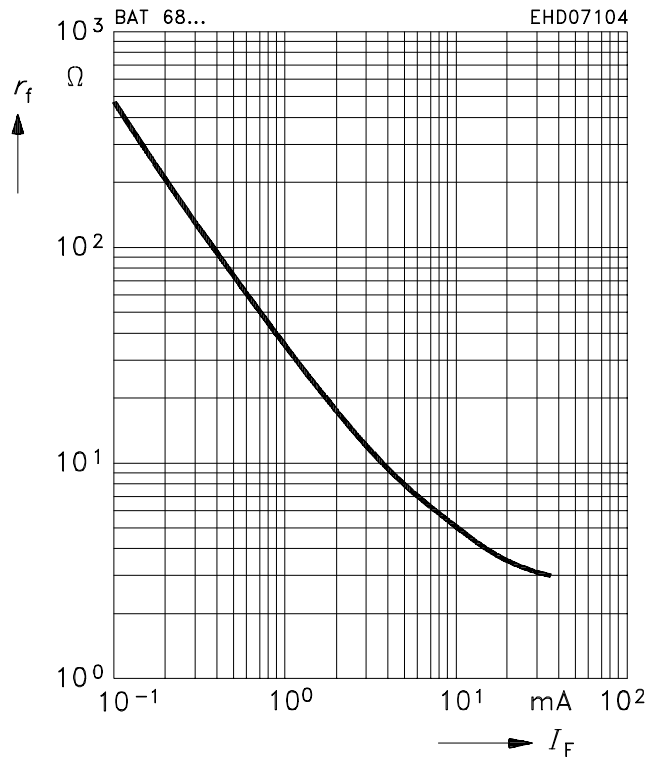

Package

