200V 300W 45MHz

RF POWER MOSFETS

N-CHANNEL ENHANCEMENT MODE

The ARF466FL is a rugged high voltage RF power transistor designed for scientific, commercial, medical and industrial RF power amplifier applications up to 45 MHz. It has been optimized for both linear and high efficiency classes of operation.

- Specified 150 Volt, 40.68 MHz Characteristics:
 - Output Power = 300 Watts.
 - Gain = 16dB (Class AB)
 - Efficiency = 75% (Class C)
- Low Cost Flangeless RF Package.
- Low Vth thermal coefficient.
- Low Thermal Resistance.
- Optimized SOA for Superior Ruggedness.

Maximum Ratings

 All Ratings: $T_c = 25^\circ\text{C}$ unless otherwise specified

Symbol	Parameter	Ratings	Unit
V_{DSS}	Drain-Source Voltage	1000	V
V_{DGO}	Drain-Gate Voltage	1000	
I_D	Continuous Drain Current @ $T_c = 25^\circ\text{C}$	13	A
V_{GS}	Gate-Source Voltage	± 30	V
P_D	Total Power Dissipation @ $T_c = 25^\circ\text{C}$	1153	W
T_J, T_{STG}	Operating and Storage Junction Temperature Range	-55 to 175	$^\circ\text{C}$
T_L	Lead Temperature: 0.063" from Case for 10 Sec.	300	

Static Electrical Characteristics

Symbol	Parameter	Min	Typ	Max	Unit
BV_{DSS}	Drain-Source Breakdown Voltage ($V_{GS} = 0V, I_D = 250 \mu\text{A}$)	1000			V
$R_{DS(ON)}$	Drain-Source On-State Resistance ¹ ($V_{GS} = 10V, I_D = 6.5A$)			1.0	ohms
I_{DSS}	Zero Gate Voltage Drain Current ($V_{DS} = 1000V, V_{GS} = 0V$)			25	μA
	Zero Gate Voltage Drain Current ($V_{DS} = 800V, V_{GS} = 0V, T_c = 125^\circ\text{C}$)			250	
I_{GSS}	Gate-Source Leakage Current ($V_{DS} = \pm 30V, V_{GS} = 0V$)			± 100	nA
g_{fs}	Forward Transconductance ($V_{DS} = 25V, I_D = 6.5A$)	3.3	7	9	mhos
$V_{GS(TH)}$	Gate Threshold Voltage ($V_{DS} = V_{GS}, I_D = 1mA$)	2		4	Volts

Thermal Characteristics

Symbol	Parameter	Min	Typ	Max	Unit
$R_{\theta JC}$	Junction to Case			0.13	$^\circ\text{C/W}$
$R_{\theta JHS}$	Junction to Sink (High Efficiency Thermal Joint Compound and Planar Heat Sink Surface.)			0.27	

 **CAUTION:** These Devices are Sensitive to Electrostatic Discharge. Proper Handling Procedures Should Be Followed.

DYNAMIC CHARACTERISTICS

ARF466FL(G)

Symbol	Characteristic	Test Conditions	MIN	TYP	MAX	UNIT
C_{iss}	Input Capacitance	$V_{GS} = 0V$ $V_{DS} = 150V$ $f = 1\text{ MHz}$		2000		pF
C_{oss}	Output Capacitance			165		
C_{rss}	Reverse Transfer Capacitance			75		
$t_{d(on)}$	Turn-on Delay Time	$V_{GS} = 15V$ $V_{DD} = 500\text{ V}$ $I_D = 13A @ 25^\circ C$ $R_G = 1.6W$		12		ns
t_r	Rise Time			10		
$t_{d(off)}$	Turn-off Delay Time			43		
t_f	Fall Time			10		

FUNCTIONAL CHARACTERISTICS

Symbol	Characteristic	Test Conditions	MIN	TYP	MAX	UNIT
G_{PS}	Common Source Amplifier Power Gain	$f = 40.68\text{ MHz}$	14	16		dB
h	Drain Efficiency	$V_{GS} = 2.5V$ $V_{DD} = 150V$	70	75		%
γ	Electrical Ruggedness VSWR 10:1	$P_{out} = 300W$	No Degradation in Output Power			

① Pulse Test: Pulse width < 380 μ S, Duty Cycle < 2%

Microsemi reserves the right to change, without notice, the specifications and information contained herein.

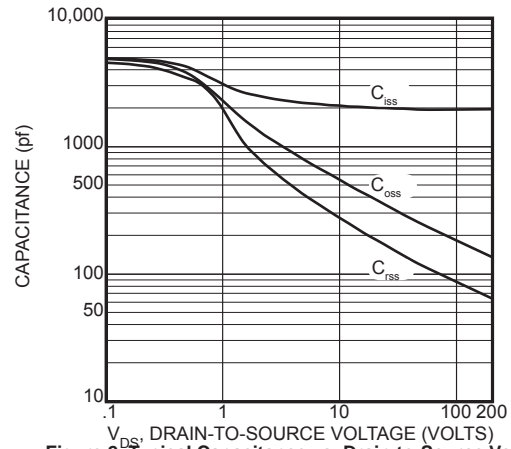

Figure 2, Typical Capacitance vs. Drain-to-Source Voltage

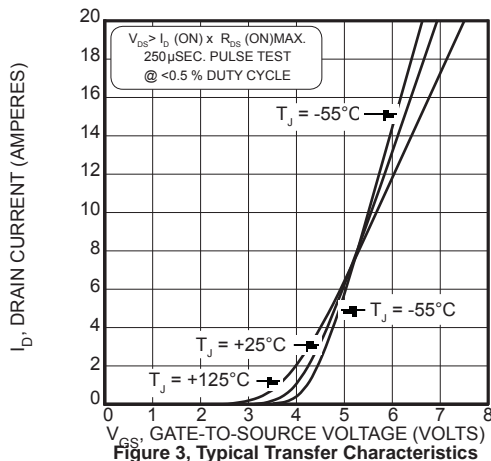

Figure 3, Typical Transfer Characteristics

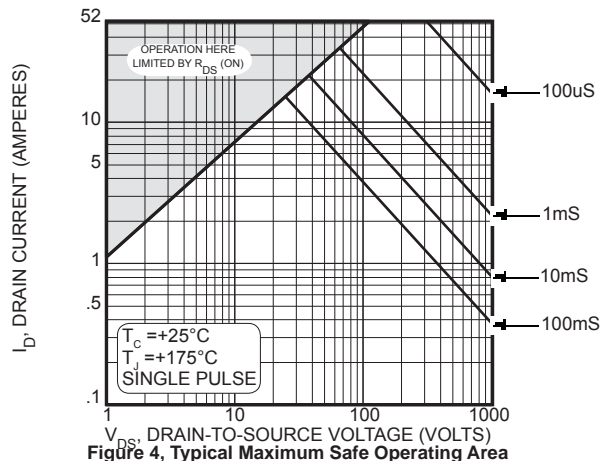

Figure 4, Typical Maximum Safe Operating Area

TYPICAL PERFORMANCE CURVES

ARF466FL(G)

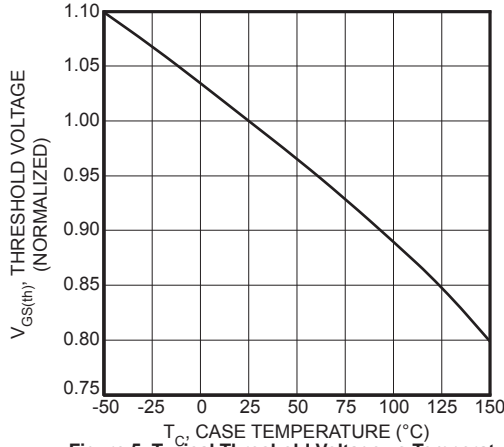

Figure 5, Typical Threshold Voltage vs Temperature

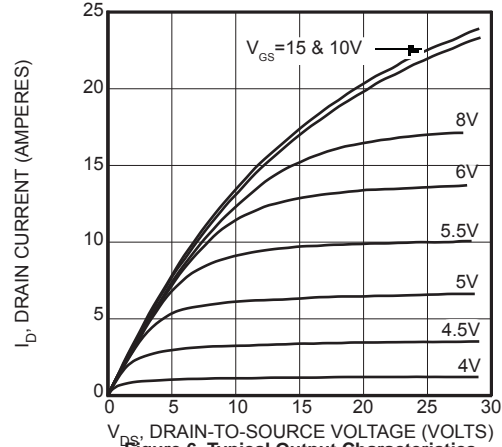

Figure 6, Typical Output Characteristics

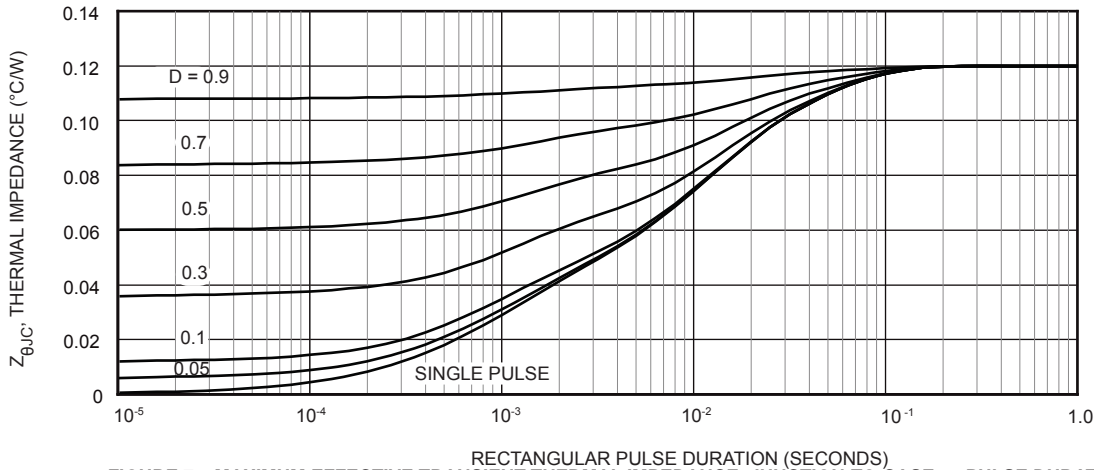

FIGURE 7a, MAXIMUM EFFECTIVE TRANSIENT THERMAL IMPEDANCE, JUNCTION-TO-CASE vs PULSE DURATION

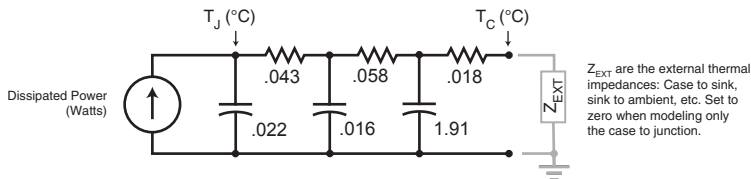

Figure 7b, TRANSIENT THERMAL IMPEDANCE MODEL

Table 1 - Typical Class AB Large Signal Input - Output Impedance

Freq. (MHz)	Z _{IN} (Ω)	Z _{OL} (Ω)
2.0	18 - j 11	30 - j 1.7
13.5	1.3 - j 5	25.7 - j 9.8
27.1	.40 - j 2.6	18 - j 13.3
40.7	.20 - j 1.6	12 - j 12.6
65	.11 + j 0.6	6.2 - j 8.9

Z_{in} - Gate shunted with 25Ω I_{DQ} = 100mA
 Z_{OL} - Conjugate of optimum load for 300 W output at V_{dd} = 150V

40.68 MHz Test Circuit

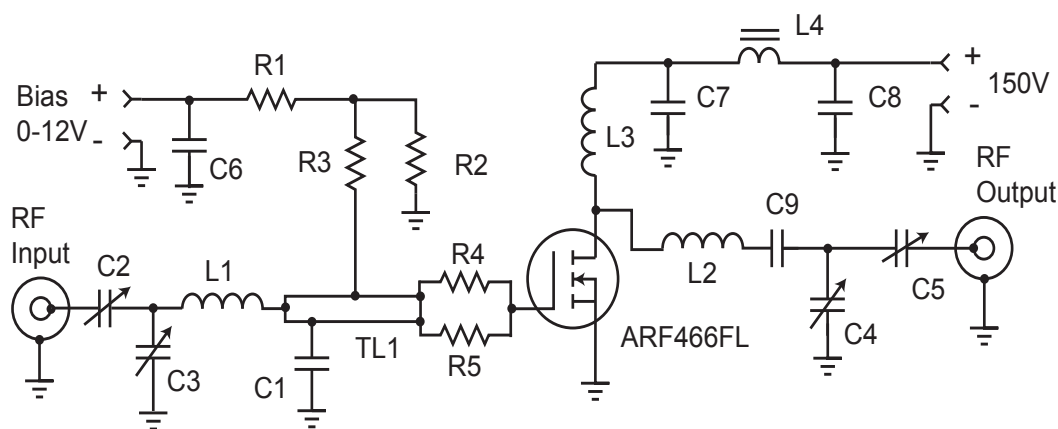

C1 -- 2200 pF ATC 700B

C2-C5 -- Arco 465 Mica trimmer

C6-C8 -- .1 mF 500V ceramic chip

C9 -- 3x 2200 pF 500V chips COG

L1 -- 3t #22 AWG .25"ID .25 "L ~55nH

L2 -- 5t #16 AWG .312" ID .35"L ~176nH

L3 -- 10t #24 AWG .25"ID ~.5uH□

L4 -- VK200-4B ferrite choke 3uH

R1- R3 -- 1k Ω 0.5WR4- R5 -- 1 Ω 1W SMTTL1 -- 40 Ω t-line 0.15 x 2"

C1 is ~1.75" from R4-5.

T3 Package Outline

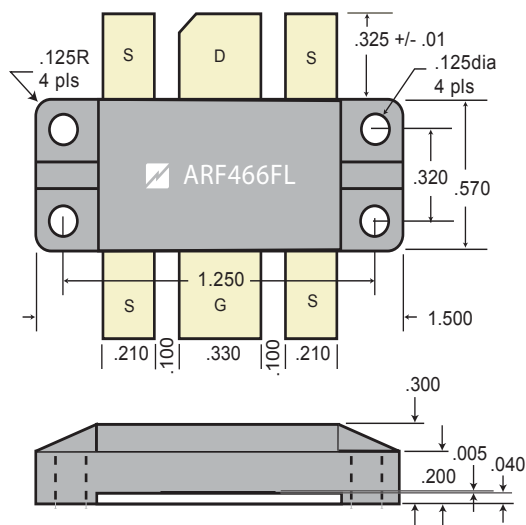

Thermal Considerations and Package Mounting:

The rated power dissipation is only available when the package mounting surface is at 25°C and the junction temperature is 175°C. The thermal resistance between junctions and case mounting surface is 0.13 °C/W. When installed, an additional thermal impedance of 0.17°C/W between the package base and the mounting surface is typical. Insure that the mounting surface is smooth and flat. Thermal joint compound must be used to reduce the effects of small surface irregularities. Use the minimum amount necessary to coat the surface. The heatsink should incorporate a copper heat spreader to obtain best results.

The package design clamps the ceramic base to the heatsink. A clamped joint maintains the required mounting pressure while allowing for thermal expansion of both the base and the heat sink. Four 4-40 (M3) screws provide the required mounting force. Torque the mounting screws to T = 2.5 - 3.5 in-lb (0.28 - 0.40 N-m).

HAZARDOUS MATERIAL WARNING

The white ceramic portion of the device between leads and mounting surface is beryllium oxide, BeO. Beryllium oxide dust is toxic when inhaled. Care must be taken during handling and mounting to avoid damage to this area. These devices must never be thrown away with general industrial or domestic waste.