



DESCRIPTION

ESD0521P is a low-capacitance Transient Voltage Suppressor (TVS) designed to provide electrostatic discharge (ESD) protection for high-speed data interfaces. With typical capacitance of 0.45pF only, ESD0521P is designed to protect parasitic-sensitive systems against over-voltage and over-current transient events. It complies with IEC 61000-4-2 (ESD), Level 4 ($\pm 15\text{kV}$ air, $\pm 8\text{kV}$ contact discharge), IEC 61000-4-4 (electrical fast transient - EFT) (40A, 5/50 ns), very fast charged device model (CDM) ESD and cable discharge event (CDE), etc.

ESD0521P uses ultra-small uDFN-2L package or FBP1006. Each ESD0521P device can protect one high-speed data line. It offers system designers flexibility to protect single data line where space is a premium concern. The combined features of low capacitance, ultra-small size and high ESD robustness make ESD0521P ideal for high-speed data port and high-frequency line (e.g., USB 2.0 & antenna line) applications, such as cellular phones and HD visual devices.

ORDERING INFORMATION

- ✧ Device: ESD0521P
- ✧ Package: uDFN-2L or FBP1006
- ✧ Marking: S
- ✧ Material: Halogen free
- ✧ Packing: Tape & Reel
- ✧ Quantity per reel: 5,000pcs or 10,000pcs

PIN CONFIGURATION

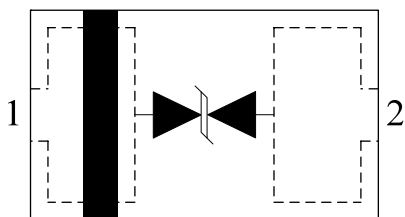

FEATURES

- ✧ Transient protection for high-speed data lines
 - IEC 61000-4-2 (ESD) $\pm 15\text{kV}$ (Air)
 - $\pm 8\text{kV}$ (Contact)
 - IEC 61000-4-4 (EFT) 40A (5/50 ns)
 - Cable Discharge Event (CDE)
- ✧ Package optimized for high-speed lines
- ✧ Ultra-small package (1.0mm \times 0.6mm \times 0.4mm)
- ✧ Protects one data, control or power line
- ✧ Low capacitance: 0.45pF (Typical)
- ✧ Low leakage current: 10nA @ VRWM (Typical)
- ✧ Low clamping voltage

MACHANICAL DATA

- ✧ uDFN-2L package or FBP1006
- ✧ Flammability Rating: UL 94V-0
- ✧ Packaging: Tape and Reel
- ✧ High temperature soldering guaranteed: $260^{\circ}\text{C}/10\text{s}$
- ✧ Reel size: 7 inch

APPLICATIONS

- ✧ Serial ATA
- ✧ Desktops, Servers and Notebooks
- ✧ Cellular Phones
- ✧ MDDI Ports
- ✧ USB2.0 Power and Data Line Protection
- ✧ Display Ports
- ✧ Digital Visual Interfaces (DVI)

PACKAGE OUTLINE

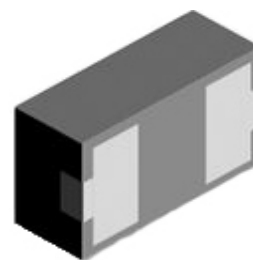

FBP1006

PIN CONFIGURATION



PACKAGE OUTLINE



ABSOLUTE MAXIMUM RATING

Symbol	Parameter	Value	Units
V_{ESD}	ESD per IEC 61000-4-2 (Air) ESD per IEC 61000-4-2 (Contact)	± 17 ± 12	kV
T_{OPT}	Operating Temperature	-55/+125	°C
T_{STG}	Storage Temperature	-55/+150	°C

ELECTRICAL CHARACTERISTICS ($T_{amb}=25^{\circ}C$)

Symbol	Parameter	Test Condition	Min	Typ	Max	Units
V_{RWM}	Reverse Working Voltage				5.0	V
V_{BR}	Reverse Breakdown Voltage	$I_T = 1mA$	6.0		7.8	V
I_R	Reverse Leakage Current	$V_{RWM} = 5V$		0.01	1.0	μA
V_{C1}	Clamping Voltage 1	$I_{PP} = 1A, t_p = 8/20\mu s$			12	V
V_{C2}	Clamping Voltage 2	$I_{PP} = 2A, t_p = 8/20\mu s$			14	V
C_J	Junction Capacitance	$V_R = 0V, f = 1MHz$		0.45	0.65	pF

ELECTRICAL CHARACTERISTICS CURVE

Voltage Sweeping of I/O to I/O

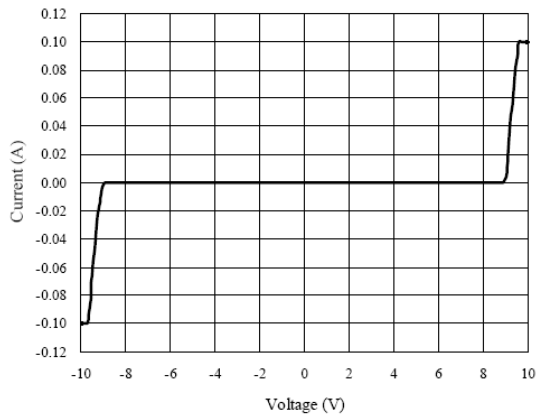

Insertion Loss S21 of I/O to I/O

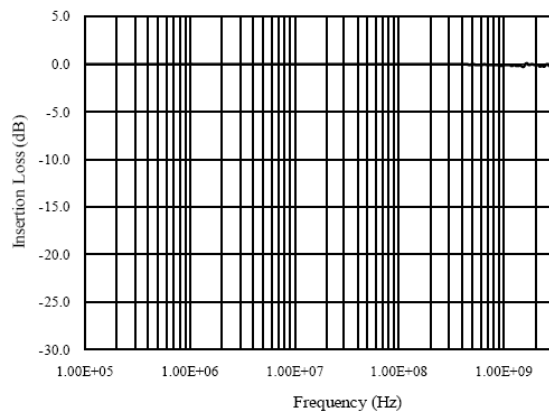

Capacitance vs. Voltage of I/O to I/O (f = 1MHz)

Capacitance vs. Reverse Voltage

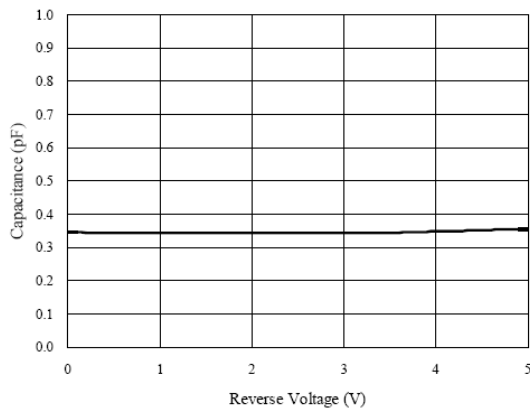

Normalized Capacitance vs. Reverse Voltage

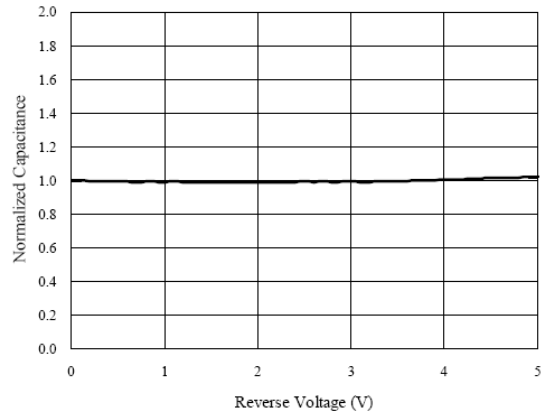

ESD Clamping of I/O to I/O (+8kV Contact per IEC 61000-4-2)

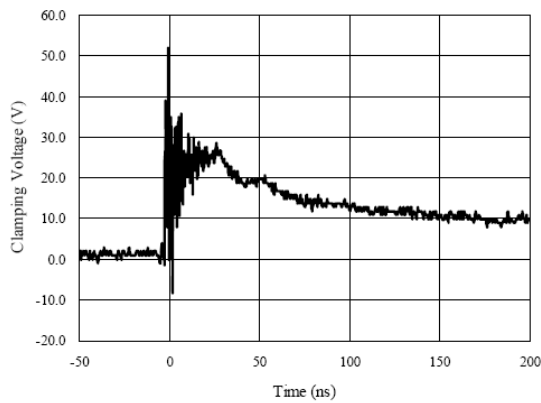

ESD Clamping of I/O to I/O (-8kV Contact per IEC 61000-4-2)

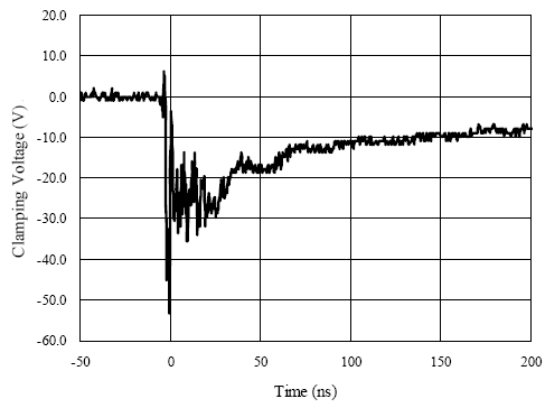

uDFN-2L PACKAGE OUTLINE DIMENSIONS

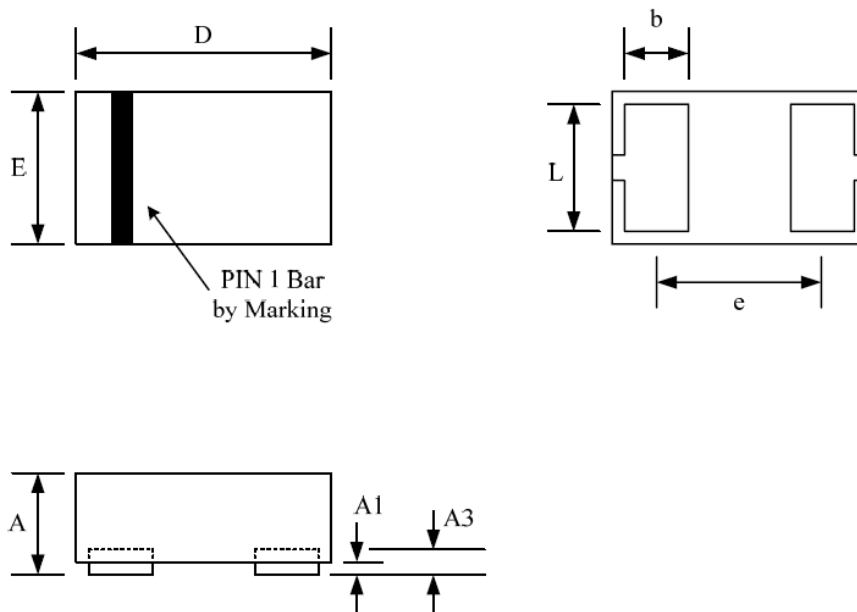

Package Dimensions (Controlling dimensions are in millimeters)

Symbol	Dimensions In Millimeters		Dimensions In Inches	
	Minimum	Maximum	Minimum	Maximum
A	0.400	0.550	0.016	0.022
A1	0.000	0.050	0.000	0.002
A3	0.125 REF		0.005 REF	
D	0.950	1.050	0.037	0.041
E	0.550	0.650	0.022	0.026
b	0.200	0.300	0.008	0.012
e	0.650 BSC		0.026 BSC	
L	0.450	0.550	0.018	0.022

FBP1006 PACKAGE OUTLINE DIMENSIONS

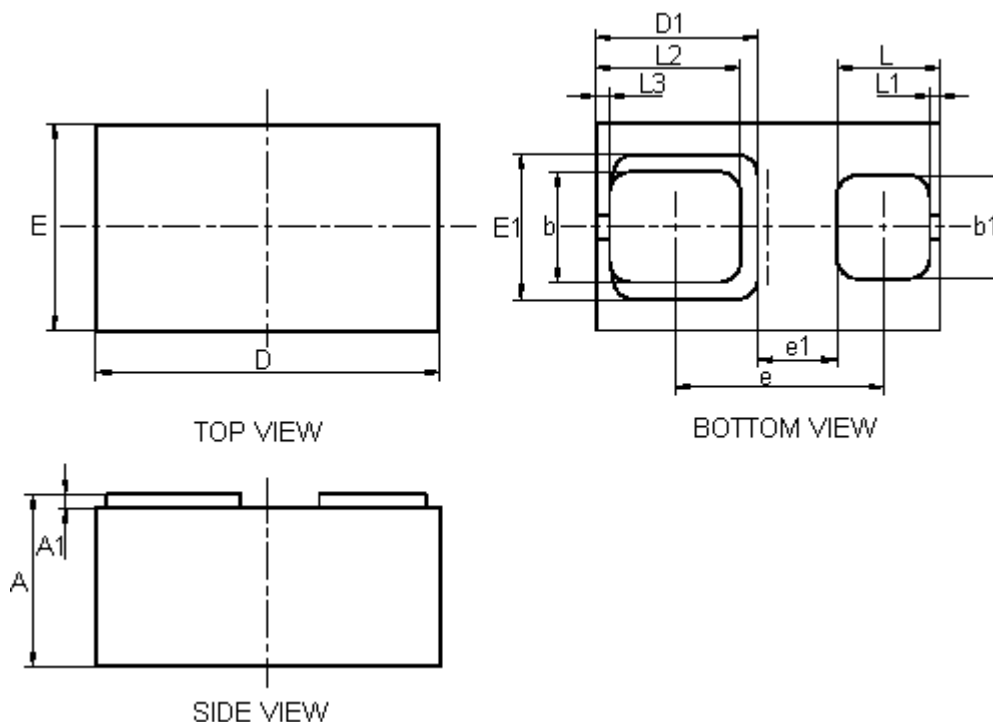

Symbol	Millimeters		Inches	
	Min	Max	Min	Max
A	0.450	0.550	0.018	0.022
A1	0.010	0.100	0.000	0.004
D	0.950	1.050	0.037	0.041
E	0.550	0.650	0.022	0.026
D1	0.470 REF		0.019 REF	
E1	0.420 REF		0.017 REF	
b	0.270	0.370	0.011	0.015
b1	0.250	0.350	0.010	0.014
e	0.555	0.655	0.022	0.026
e1	0.230 REF		0.009 REF	
L	0.250	0.350	0.010	0.014
L1	0.030 REF		0.001 REF	
L2	0.370	0.470	0.015	0.019
L3	0.040 REF		0.002 REF	