

# Surface Mount Ferrite Chip Beads Array

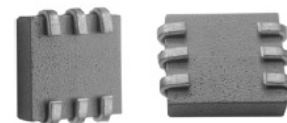

5.60 x 5.00 x 1.50mm

ACSB-04-T



RoHS/RoHS II Compliant

## FEATURES:

- Suitable for high density mounting or where board space is at a premium.
- Superior attenuation across a broad frequency range up to GHz range.
- Wide operating temperature range of -40°C to +85°C.
- RoHS Compliant and lead free.

## APPLICATIONS:

- Notebooks, Tablets, Smartphones, Cameras, DVD/Blu-ray players, LED TVs, Motherboards, Power Supplies, Modems

## STANDARD SPECIFICATIONS:

### PARAMETERS

ABRACON P/N:	ACSB-04-T
Operating temperature:	-40°C to +85°C
Storage Temperature and Humidity (In Tape and Reel)	+5°C to +40°C, 60% to 70% RH

### Key Electrical Specifications

Impedance	Test Frequency	RDC	IDC
$\Omega$	MHz	$\Omega$ Max	A Max
23 Ref	25	9	5
50 Ref	100		

### Test Conditions

Instrument: Agilent 4294A Precision Impedance Analyzer.

IDC: Based on temperature rise ( $\Delta T$  : 40°C TYP. )

## ELECTRICAL CHARACTERISTIC CURVE

Typical Impedance v.s. Frequency Curve

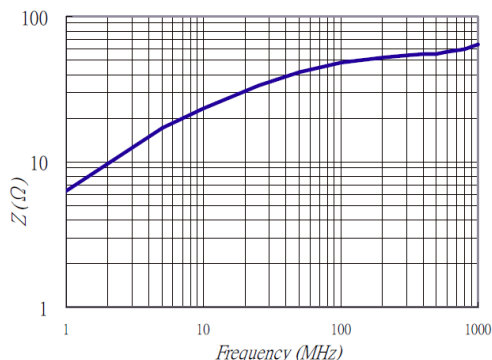

## OUTLINE DIMENSIONS:

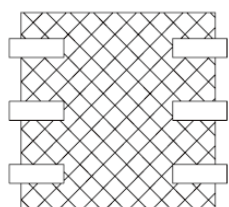
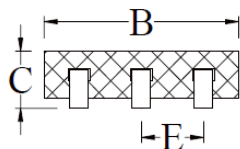
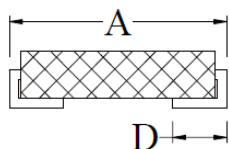

A	B Max	C	D	E
5.60±0.30	5.00	1.50±0.20	1.40±0.15	1.3±0.2

### Recommended Land Pattern

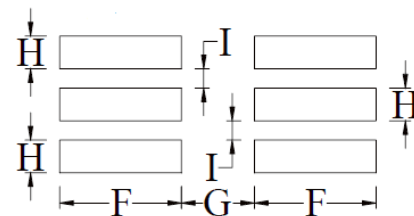

F	G	H	I
3.00 ref.	1.8 ref.	0.80 ref.	0.47 ref.

Dimension: mm

ABRACON IS  
ISO 9001:2008  
CERTIFIED



Visit [www.abracon.com](http://www.abracon.com) for Terms & Conditions of Sale  
30332 Esperanza, Rancho Santa Margarita, California 92688  
tel 949-546-8000 | fax 949-546-8001 | [www.abracon.com](http://www.abracon.com)

Revised: 09.20.13

# Surface Mount Ferrite Chip Beads Array

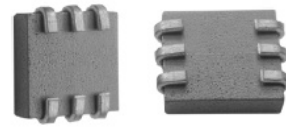

5.60 x 5.00 x 1.50mm

ACSB-04-T

RoHS/RoHS II Compliant

## REFLOW PROFILE:

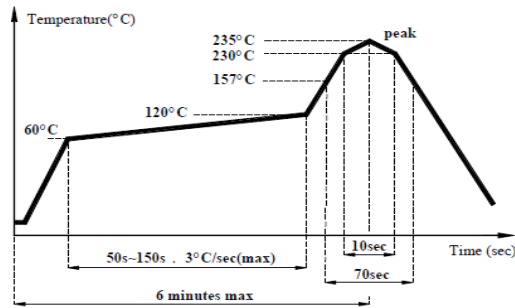

## TAPE & REEL:

**Packing**  
T: 1000pcs / reel

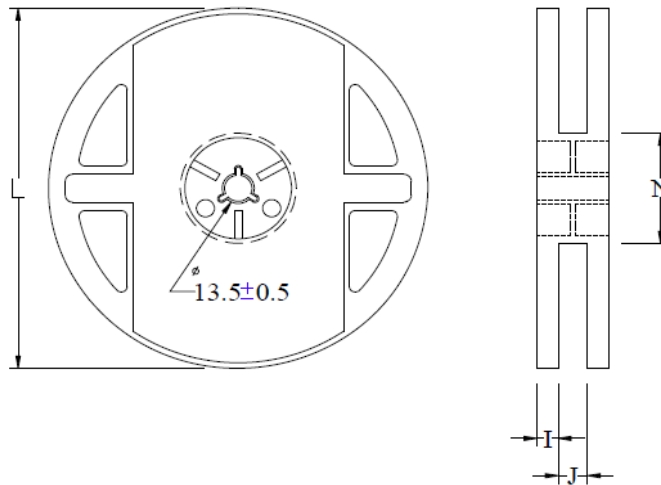
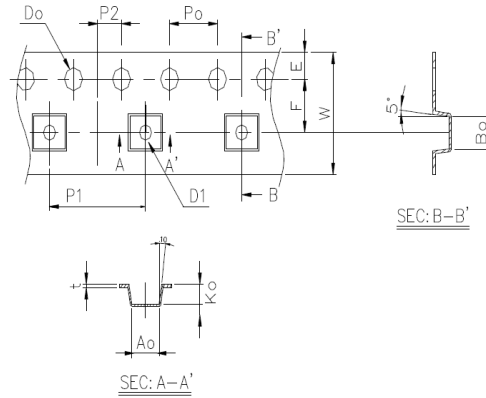

A0	B0	K0	D0	D1	F	P1	W	t	L	I	J	N
4.7 ± 0.1	5.74 ± 0.1	1.82 ± 0.1	1.5 ± 0.1	1.5 ± 0.05	5.5 ± 0.05	8 ± 0.1	12 ± 0.2	0.25 ± 0.05	178	1.4	12	60

**Dimension: mm**

**ATTENTION:** Abracon Corporation's products are COTS – Commercial-Off-The-Shelf products; suitable for Commercial, Industrial and, where designated, Automotive Applications. Abracon's products are not specifically designed for Military, Aviation, Aerospace, Life-dependant Medical applications or any application requiring high reliability where component failure could result in loss of life and/or property. For applications requiring high reliability and/or presenting an extreme operating environment, written consent and authorization from Abracon Corporation is required. Please contact Abracon Corporation for more information.

ABRACON IS  
ISO 9001:2008  
CERTIFIED



Visit [www.abracon.com](http://www.abracon.com) for Terms & Conditions of Sale  
30332 Esperanza, Rancho Santa Margarita, California 92688  
tel 949-546-8000 | fax 949-546-8001 | [www.abracon.com](http://www.abracon.com)

Revised: 09.20.13