

Power Operational Amplifier

FEATURES

- POWER MOS TECHNOLOGY — 2A peak rating
- HIGH GAIN BANDWIDTH PRODUCT — 150MHz
- VERY FAST SLEW RATE — 200V/μs
- PROTECTED OUTPUT STAGE — Thermal shutoff
- EXCELLENT LINEARITY — Class A/B output
- WIDE SUPPLY RANGE — ±12V to ±40V
- LOW BIAS CURRENT, LOW NOISE — FET input

8-PIN TO-3

PACKAGE STYLE CE

APPLICATIONS

- VIDEO DISTRIBUTION AND AND AMPLIFICATION
- HIGH SPEED DEFLECTION CIRCUITS
- POWER TRANSDUCERS TO 2MHz
- COAXIAL LINE DRIVERS
- POWER LED OR LASER DIODE EXCITATION

DESCRIPTION

The PA09 is a high voltage, high output current operational amplifier optimized to drive a variety of loads from DC through the video frequency range. Excellent input accuracy is achieved with a dual monolithic FET input transistor which is cascoded by two high voltage transistors to provide outstanding common mode characteristics. All internal current and voltage levels are referenced to a zener diode biased on by a current source. As a result, the PA09 exhibits superior DC and AC stability over a wide supply and temperature range.

High speed and freedom from second breakdown is assured by a complementary Power MOS output stage. For optimum linearity, especially at low levels, the Power MOS transistors are biased in the class A/B mode. Thermal shutoff provides full protection against overheating and limits the heatsink requirements to dissipate the internal power losses under normal operating conditions. A built-in current limit protects the amplifier against overloading. Transient inductive load kickback protection is provided by two internal clamping diodes. External phase compensation allows the user maximum flexibility in obtaining the optimum slew rate and gain bandwidth product at all gain settings. For continuous operation under load, a heatsink of proper rating is recommended.

This hybrid integrated circuit utilizes thick film (cermet) resistors, ceramic capacitors and silicon semiconductor chips to maximize reliability, minimize size and give top performance. Ultrasonically bonded aluminum wires provide reliable interconnections at all operating temperatures. The CE, 8-pin TO-3 package is hermetically sealed and electrically isolated. The use of compressible thermal washers and/or improper mounting torque will void the product warranty. Please see "General Operating Considerations".

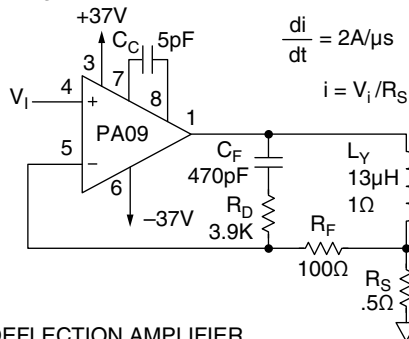
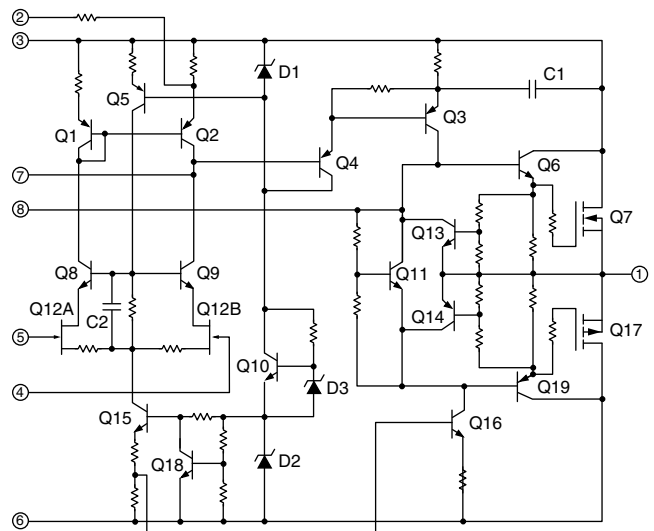

FIGURE 1. PA09 AS DEFLECTION AMPLIFIER

DEFLECTION AMPLIFIER (FIGURE 1)

The deflection amplifier circuit of Figure 1 achieves arbitrary beam positioning for a fast heads-up display. Maximum transition times are 4μs while delivering 2A pk currents to the 13mH coil. The key to this circuit is the sense resistor (R_S) which converts yoke current to voltage for op amp feedback. This negative feedback forces the coil current to stay exactly proportional to the control voltage. The network consisting of R_D , R_F and C_F serves to shift from a current feedback via R_S to a direct voltage feedback at high frequencies. This removes the extra phase shift caused by the inductor thus preventing oscillation. See Application Note 5 for details of this and other precision magnetic deflection circuits.

EQUIVALENT SCHEMATIC



EXTERNAL CONNECTIONS

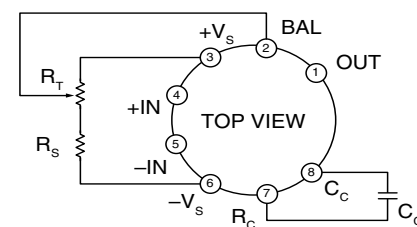

$$R_S = (|+V_S| + |-V_S|) R_T / 1.6$$

NOTE: Input offset voltage trim optional. $R_T = 10K\Omega$ MAX

ABSOLUTE MAXIMUM RATINGS

| | |
|--|-----------------|
| SUPPLY VOLTAGE, +V _s to -V _s | 80V |
| OUTPUT CURRENT, within SOA | 5A |
| POWER DISSIPATION, internal ¹ | 78W |
| INPUT VOLTAGE, differential | 40V |
| INPUT VOLTAGE, common mode | ±V _s |
| TEMPERATURE, pin solder - 10s | 300°C |
| TEMPERATURE, junction ¹ | 150°C |
| TEMPERATURE RANGE, storage | -65 to +150°C |
| OPERATING TEMPERATURE RANGE, case | -55 to +125°C |

SPECIFICATIONS

| PARAMETER | TEST CONDITIONS ² | PA09 | | | PA09A | | | UNITS |
|--|---|----------------------|---------------------|------|-------|-------|------|-------|
| | | MIN | TYP | MAX | MIN | TYP | MAX | |
| INPUT | | | | | | | | |
| OFFSET VOLTAGE, initial | | | .5 | ± 3 | | ± .25 | ± .5 | mV |
| OFFSET VOLTAGE, vs. temperature | Full temperature range | | 10 | 30 | | 5 | 10 | μV/°C |
| OFFSET VOLTAGE, vs. supply | | | 10 | | | * | | μV/V |
| BIAS CURRENT, initial | | | 5 | 100 | | 3 | 20 | pA |
| BIAS CURRENT, vs. supply | | | .01 | | | * | | pA/V |
| OFFSET CURRENT, initial | | | 2.5 | 50 | | 1.5 | 10 | pA |
| INPUT IMPEDANCE, DC | | | 10 ¹¹ | | | * | | Ω |
| INPUT CAPACITANCE | | | 6 | | | * | | pF |
| COMMON MODE VOLTAGE RANGE ³ | Full temperature range | ± V _s -10 | ± V _s -8 | | * | * | | V |
| COMMON MODE REJECTION, DC | Full temperature range, V _{CM} = ± 20V | | 104 | | | * | | dB |
| GAIN | | | | | | | | |
| OPEN LOOP GAIN at 15Hz | R _L = 1kΩ | 80 | 98 | | | * | | dB |
| GAIN BANDWIDTH PRODUCT at 1MHz | C _C = 5pF | | 150 | | | * | | MHz |
| POWER BANDWIDTH | R _L = 15Ω, C _C = 5pF | | 750 | | | * | | KHz |
| POWER BANDWIDTH | R _L = 15Ω, C _C = 100pF | | 150 | | | * | | KHz |
| OUTPUT | | | | | | | | |
| VOLTAGE SWING ³ | Full temperature range, I _O = 2A | ± V _s -8 | ± V _s -7 | | * | * | | V |
| CURRENT, PEAK | | | 4.5 | | | * | | A |
| SETTLING TIME to 1% | 4V step, C _C = 100pF | | .75 | | | * | | μs |
| SETTLING TIME to .1% | 4V step, C _C = 100pF | | 1.3 | | | * | | μs |
| SLEW RATE | C _C = 5pF | | 220 | | | * | | V/μs |
| SLEW RATE | C _C = 100pF | | 25 | | | * | | V/μs |
| RESISTANCE | | | 7.5 | | | * | | Ω |
| POWER SUPPLY | | | | | | | | |
| VOLTAGE | Full temperature range | ± 12 | ± 35 | ± 40 | * | * | * | V |
| CURRENT, quiescent | | | 70 | 85 | | * | * | mA |
| THERMAL | | | | | | | | |
| RESISTANCE, AC junction to case ⁴ | Full temperature range, F > 60Hz | | 1.2 | 1.3 | | * | * | °C/W |
| RESISTANCE, DC junction to case | Full temperature range, F < 60Hz | | 1.6 | 1.8 | | * | * | °C/W |
| RESISTANCE, junction to air | Full temperature range | | 30 | | | * | * | °C/W |
| TEMPERATURE RANGE, case | Meets full range specifications | -25 | 25 | + 85 | * | * | * | °C |

- NOTES: * The specification of PA09A is identical to the specification for PA09 in applicable column to the left.
1. Long term operation at the maximum junction temperature will result in reduced product life. Derate power dissipation to achieve high MTTF.
 2. Unless otherwise noted: T_C = 25°C, supply voltage = ±35V.
 3. +V_s and -V_s denote the positive and negative supply rail respectively. Total V_s is measured from +V_s to -V_s.
 4. Rating applies if the output current alternates between both output transistors at a rate faster than 60Hz.

The internal substrate contains beryllia (BeO). Do not break the seal. If accidentally broken, do not crush, machine, or subject to temperatures in excess of 850°C to avoid generating toxic fumes.

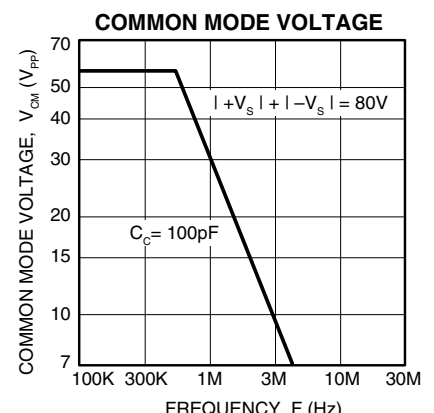
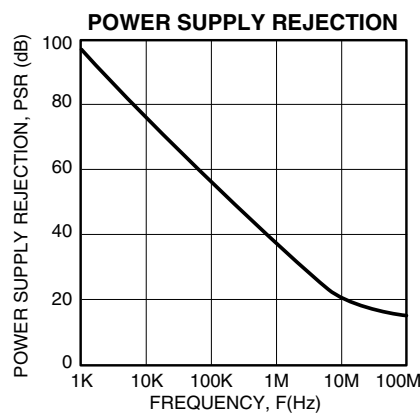
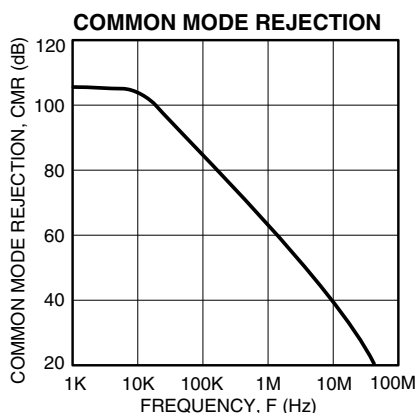
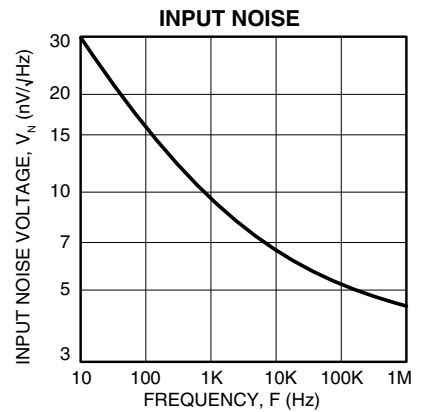
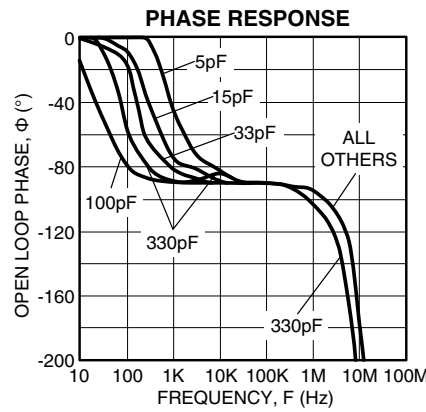
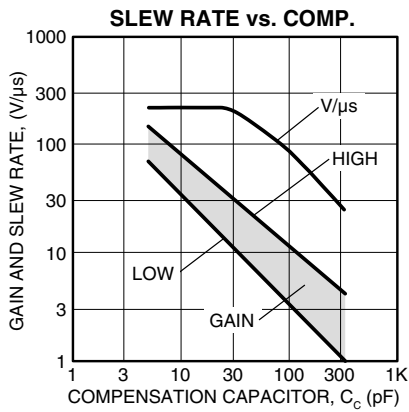
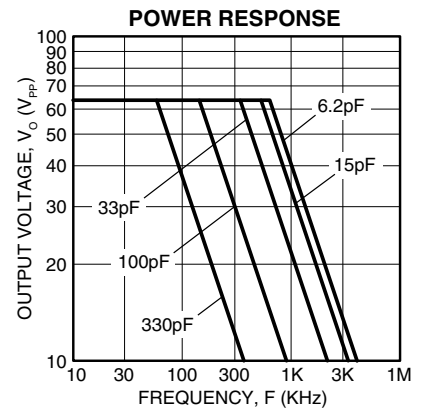
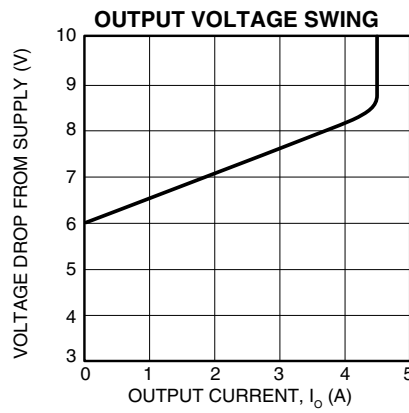
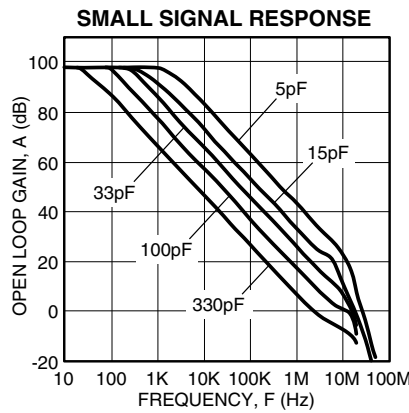
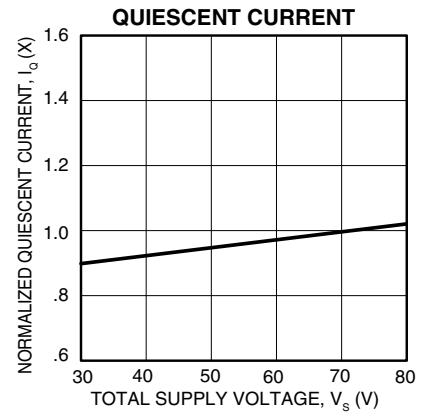
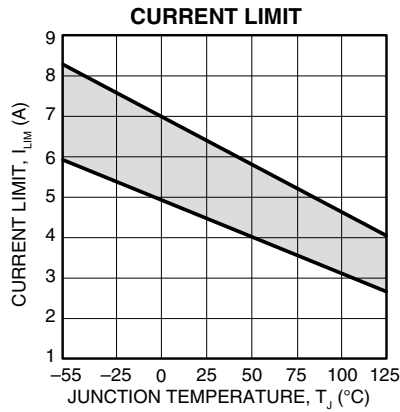
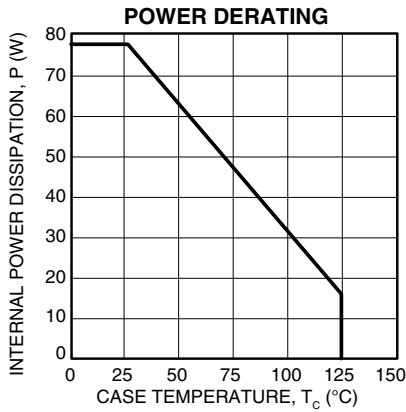

GENERAL

Please read Application Note 1 "General Operating Considerations" which covers stability, supplies, heat sinking, mounting, current limit, SOA interpretation, and specification interpretation. Visit www.Cirrus.com for design tools that help automate tasks such as calculations for stability, internal power dissipation, current limit; heat sink selection; Apex Precision Power's complete Application Notes library; Technical Seminar Workbook; and Evaluation Kits.

SUPPLY VOLTAGE

The specified voltage ($\pm V_s$) applies for a dual (\pm) supply having equal voltages. A nonsymmetrical (ie. +70/-10V) or a single supply (ie. 80V) may be used as long as the total voltage between the $+V_s$ and $-V_s$ rails does not exceed the sum of the voltages of the specified dual supply.

SAFE OPERATING AREA (SOA)

The MOSFET output stage of this power operational amplifier has two distinct limitations:

1. The current handling capability of the MOSFET geometry and the wire bonds.
2. The junction temperature of the output MOSFETs.

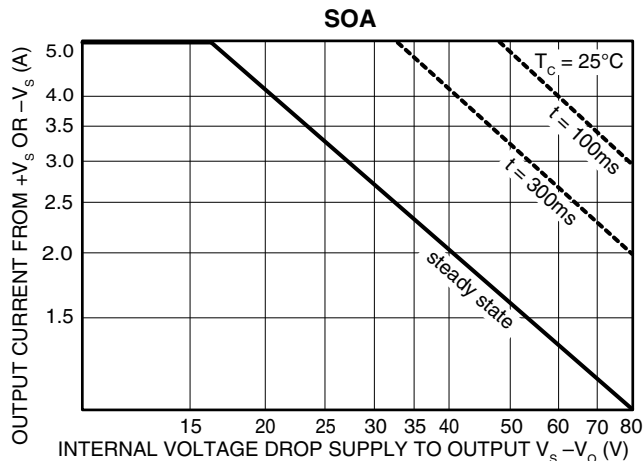

SAFE OPERATING AREA CURVES

The SOA curves combine the effect of these limits and allow for internal thermal delays. For a given application, the direction and magnitude of the output current should be calculated or measured and checked against the SOA curves. This is simple for resistive loads but more complex for reactive and EMF generating loads. The following guidelines may save extensive analytical efforts:

1. Capacitive and inductive loads up to the following maximums are safe:

| $\pm V_s$ | CAPACITIVE LOAD | INDUCTIVE LOAD |
|-----------|-----------------|----------------|
| 40V | .1 μ F | 11mH |
| 30V | 500 μ F | 24mH |
| 20V | 2500 μ F | 75mH |
| 15V | ∞ | 100mH |

2. Short circuits to ground are safe with dual supplies up to $\pm 20V$.
3. The output stage is protected against transient flyback. However, for protection against sustained, high energy flyback, external fast-recovery diodes should be used.

BYPASSING OF SUPPLIES

Each supply rail must be bypassed to common with a tantalum capacitor of at least 47 μ F in parallel with a .47 μ F ceramic capacitor directly connected from the power supply pins to the ground plane.

OUTPUT LEADS

Keep the output leads as short as possible. In the video frequency range, even a few inches of wire have significant inductance, raising the interconnection impedance and limiting the output current slew rate. Furthermore, the skin effect increases the resistance of heavy wires at high frequencies. Multistrand Litz Wire is recommended to carry large video currents with low losses.

GROUNDING

Single point grounding of the input resistors and the input signal to a common ground plane will prevent undesired current feedback, which can cause large errors and/or instabilities. "Single point" is a key phrase here; a ground plane should be used as shielding rather than a current path. Leaving the case of the PA09 floating will cause oscillations in some applications.

COMPENSATION

The PA09 is extremely flexible in terms of choice of compensation capacitor for any given gain. The most common ranges are shown in the COMPENSATION typical performance graph. Swinging closer to the supply rails, heavier loads, faster input signal rise and fall times and higher supply voltages all tend to demand larger values of compensation capacitor. This capacitor must be rated at least as high as the total voltage applied to the amplifier. In making specific value choices, use the square wave stability test presented in APPLICATION NOTE 19, Figures 40 and 41.

In addition to small signal testing, if the application includes step functions in the input signal, use this circuit to measure large signal response. By increasing square wave amplitude to the maximum of the application, this test may show significant distortion of the output waveform following the square wave transitions. In this case the faster input stages of the PA09 are out-running the output stage and overload recovery time creates the distortion. This speed relationship is also why slew rate does not increase for compensation values below about 27pF.

SUPPLY CURRENT

When swinging large signals, the output stage of the PA09 demands extra supply current. The following graphs illustrate this current for several conditions for both sine and square wave signals. Current is exclusive of any load current and will affect both supply rating and thermal ratings. When calculating internal power dissipation, multiply this current times total supply voltage.

Note that swinging closer to the supply rail demands more

current. Output voltage is given as peak. Currents are average responding supply readings, but AC monitoring will reveal current pulses corresponding to periods of high slew rate. For

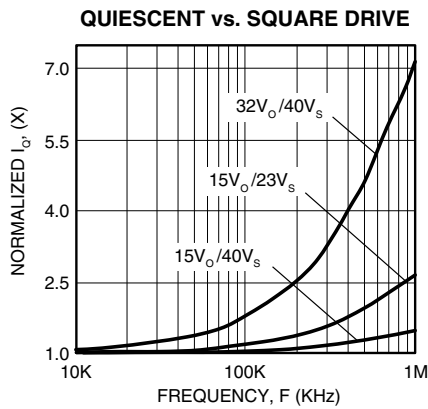
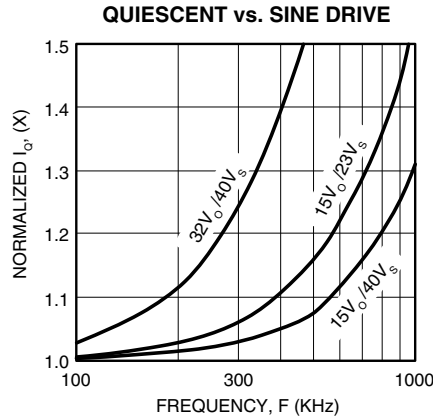

example, driving $\pm 30V$ outputs at 500KHz on $\pm 40V$ supplies produces a .8A pulse during negative slew and a 1.2A pulse during positive slew. If the input signal is over driven by several times the output swing capability, pulses up to 4A may be seen.

THERMAL SHUTDOWN PROTECTION

The thermal protection circuit shuts off the amplifier when the substrate temperature exceeds approximately 150°C. This allows heatsink selection to be based on normal operating conditions while protecting the amplifier against excessive junction temperature during temporary fault conditions.

Thermal protection is a fairly slow-acting circuit and therefore

does not protect the amplifier against transient SOA violations (areas outside of the $T_c = 25^\circ C$ boundary). It is designed to protect against short-term fault conditions that result in high power dissipation within the amplifier. If the conditions that cause thermal shutdown are not removed, the amplifier will oscillate in and out of shutdown. This will result in high peak power stresses, destroy signal integrity, and reduce the reliability of the device.

STABILITY

Due to its large bandwidth the PA09 is more likely to oscillate than lower bandwidth Power Operational Amplifiers. To prevent oscillations a reasonable phase margin must be maintained by:

1. Pay very careful attention to supply bypassing and circuit grounding. This is very important when step functions are driven and the PA09 shares supplies with more active devices.
2. Keeping the external sumpoint stray capacitance to ground at a minimum and the sumpoint load resistance (input and feedback resistors in parallel) below 500Ω. Larger sumpoint load resistances can be used with increased phase compensation and/or bypassing of the feedback resistor.
3. Connect the case to a local AC ground potential.

CURRENT LIMIT

Internal current limiting is provided in the PA09. Note the current limit curve given under typical performance graphs is based on junction temperature. If the amplifier is operated at cold junction temperatures, current limit could be as high as 8 amps. This is above the maximum allowed current on the SOA curve of 5 amps. Systems using this part must be designed to keep the maximum output current to less than 5 amps under all conditions. The internal current limit only provides this protection for junction temperatures of 80°C and above.



CONTACTING CIRRUS LOGIC SUPPORT

For all Apex Precision Power product questions and inquiries, call toll free 800-546-2739 in North America.

For inquiries via email, please contact apex.support@cirrus.com.

International customers can also request support by contacting their local Cirrus Logic Sales Representative.

To find the one nearest to you, go to www.cirrus.com

IMPORTANT NOTICE

Cirrus Logic, Inc. and its subsidiaries ("Cirrus") believe that the information contained in this document is accurate and reliable. However, the information is subject to change without notice and is provided "AS IS" without warranty of any kind (express or implied). Customers are advised to obtain the latest version of relevant information to verify, before placing orders, that information being relied on is current and complete. All products are sold subject to the terms and conditions of sale supplied at the time of order acknowledgment, including those pertaining to warranty for the use of this information, including use of this information as the basis for manufacture or sale of any items, or for infringement of patents or other rights of third parties. This document is the property of Cirrus and by furnishing this information, Cirrus grants no license, express or implied under any patents, mask work rights, copyrights, trademarks, trade secrets or other intellectual property rights. Cirrus owns the copyrights associated with the information contained herein and gives consent for copies to be made of the information only for use within your organization with respect to Cirrus integrated circuits or other products of Cirrus. This consent does not extend to other copying such as copying for general distribution, advertising or promotional purposes, or for creating any work for resale.

CERTAIN APPLICATIONS USING SEMICONDUCTOR PRODUCTS MAY INVOLVE POTENTIAL RISKS OF DEATH, PERSONAL INJURY, OR SEVERE PROPERTY OR ENVIRONMENTAL DAMAGE ("CRITICAL APPLICATIONS"). CIRRUS PRODUCTS ARE NOT DESIGNED, AUTHORIZED OR WARRANTED TO BE SUITABLE FOR USE IN PRODUCTS SURGICALLY IMPLANTED INTO THE BODY, AUTOMOTIVE SAFETY OR SECURITY DEVICES, LIFE SUPPORT PRODUCTS OR OTHER CRITICAL APPLICATIONS. INCLUSION OF CIRRUS PRODUCTS IN SUCH APPLICATIONS IS UNDERSTOOD TO BE FULLY AT THE CUSTOMER'S RISK AND CIRRUS DISCLAIMS AND MAKES NO WARRANTY, EXPRESS, STATUTORY OR IMPLIED, INCLUDING THE IMPLIED WARRANTIES OF MERCHANTABILITY AND FITNESS FOR PARTICULAR PURPOSE, WITH REGARD TO ANY CIRRUS PRODUCT THAT IS USED IN SUCH A MANNER. IF THE CUSTOMER OR CUSTOMER'S CUSTOMER USES OR PERMITS THE USE OF CIRRUS PRODUCTS IN CRITICAL APPLICATIONS, CUSTOMER AGREES, BY SUCH USE, TO FULLY INDEMNIFY CIRRUS, ITS OFFICERS, DIRECTORS, EMPLOYEES, DISTRIBUTORS AND OTHER AGENTS FROM ANY AND ALL LIABILITY, INCLUDING ATTORNEYS' FEES AND COSTS, THAT MAY RESULT FROM OR ARISE IN CONNECTION WITH THESE USES.

Cirrus Logic, Cirrus, and the Cirrus Logic logo designs, Apex Precision Power, Apex and the Apex Precision Power logo designs are trademarks of Cirrus Logic, Inc. All other brand and product names in this document may be trademarks or service marks of their respective owners.