

NCP1423, SCV1423

400 mA Sync-Rect PFM Step-Up DC-DC Converter with True-Cutoff and Ring-Killer

NCP1423 is a monolithic micropower high frequency step-up switching converter IC specially designed for battery operated hand-held electronic products. It integrates Synchronous Rectifier for improving efficiency as well as eliminating the external Schottky Diode. High switching frequency (up to 600 kHz) allows low profile inductor and output capacitor being used. When the IC is disabled, internal conduction path from LX or BAT to OUT is blocked, OUT pin is isolated from the battery. This achieves True-Cutoff. Ring-Killer is also integrated to eliminate the high frequency ringing in discontinuous conduction mode. Low-Battery Detector, Cycle-by-Cycle Current Limit, Overvoltage Protection and Thermal Shutdown provide value-added features for various battery operated application. With all of these functions ON, the quiescent supply current is only 9.0 μ A. This device is available in compact Micro10 package.

Features

- High Efficiency: 92% for 3.3 V Output@ 400 mA from 2.5 V Input
87% for 1.8 V Output@ 70 mA from 1.2 V Input
- High Switching Frequency, up to 600 kHz (not hitting current limit)
- Low Quiescent Current of 9.0 μ A
- Low Battery Detector
- 0.8 V Startup
- External Adjustable Output Voltage
- $\pm 1.5\%$ Output Voltage Accuracy
- Ring-Killer for Discontinuous Conduction Mode
- Thermal Shutdown
- 1.2 A Cycle-by-Cycle Current Limit
- Output Current up to 400 mA @ $V_{OUT} = 3.3$ V,
200 mA @ $V_{OUT} = 1.8$ V
- Overvoltage Protection
- Low Profile and Minimum External Part
- Open Drain Low-Battery Detector Output
- Compact Micro10 Package
- SCV Prefix for Automotive and Other Applications Requiring Unique Site and Control Change Requirements; AEC-Q100 Qualified and PPAP Capable
- These Devices are Pb-Free and are RoHS Compliant

Typical Applications

- Wireless Optical Mouse
- Wireless Headsets
- Internet Audio Players
- Personal Digital Assistants (PDAs)
- Hand-held Instruments
- Conversion from one/two NiMH or NiCd cells to 1.8 V / 3.3 V



ON Semiconductor®

<http://onsemi.com>

MARKING DIAGRAM

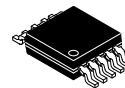

Micro10
DM SUFFIX
CASE 846B

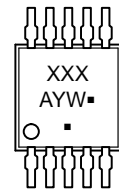

XXX = DAR (NCP1423)
= GEN (SCV1423)
A = Assembly Location
Y = Year
W = Work Week
▪ = Pb-Free Package

(Note: Microdot may be in either location)

PIN CONNECTIONS

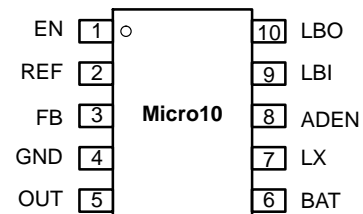

(Top View)

ORDERING INFORMATION

Device	Package	Shipping†
NCP1423DMR2G	Micro10 (Pb-Free)	4000 Tape & Reel
SCV1423DMR2G	Micro10 (Pb-Free)	4000 Tape & Reel

†For information on tape and reel specifications, including part orientation and tape sizes, please refer to our Tape and Reel Packaging Specifications Brochure, BRD8011/D.

NCP1423, SCV1423

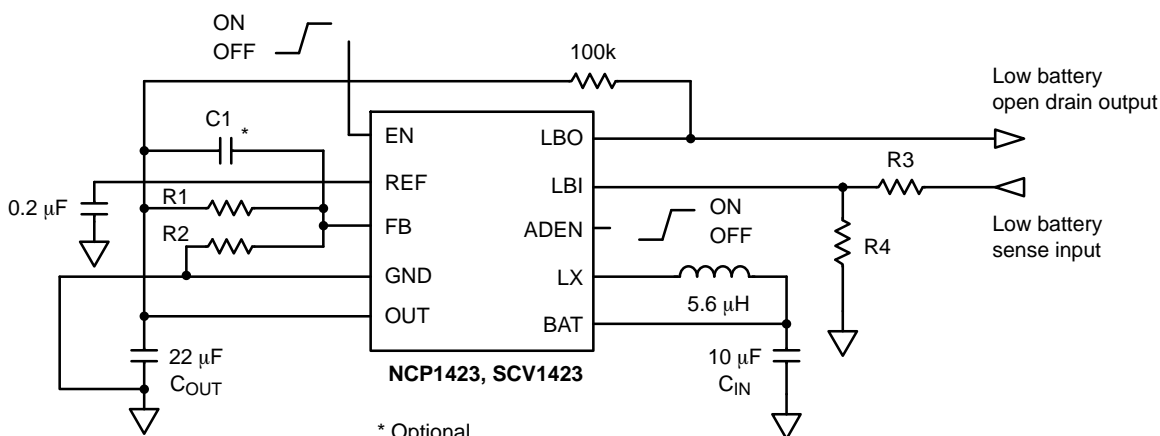

Figure 1. Typical Operation Circuit

PIN DESCRIPTION

Pin No.	Symbol	Description
1	EN	Low-Battery Detector Input and Enable. With this pin pulled down below 0.5 V, the device will be disabled and will enter shutdown mode
2	REF	1.195 V Reference Voltage Output, bypass with 0.1 μF capacitor if this pin is not loaded, with a 1.0 μF bypassing capacitor, this pin can be loaded up to 2.5 mA @ V _{OUT} = 3.3 V.
3	FB	Output Voltage Feedback Input
4	GND	Ground
5	OUT	Power Output. OUT provides bootstrap power to the IC
6	BAT	Battery supply input pin and connection for internal Ring-Killer
7	LX	N-Channel and P-Channel Power MOSFET Drain
8	ADEN	Auto Discharge Input
9	LBI	Low-Battery Detector Input
10	LBO	Open-Drain Low-Battery Detector Output. Output is Low when V _{LBI} is < 500 mV. LBO is high impedance shutdown

MAXIMUM RATINGS

Rating	Symbol	Value	Unit
Power Supply (Pin 6)	V _{OUT}	-0.3, 6.0	V
Input / Output Pins (Pins 1-3,5,7-10)	V _{IO}	-0.3, 6.0	V
Thermal Characteristics Micro10 Plastic Package, Case 846B, T _A = 25°C Thermal Resistance Junction-to-Air	P _D R _{θJA}	480 250	mW °C/W
Operating Junction Temperature Range	T _J	- 40 to + 150	°C
Operating Ambient Temperature Range	T _A	- 40 to + 85	°C
Storage Temperature Range	T _{stg}	- 55 to +150	°C

Stresses exceeding those listed in the Maximum Ratings table may damage the device. If any of these limits are exceeded, device functionality should not be assumed, damage may occur and reliability may be affected.

NOTE: ESD data available upon request.

- This device contains ESD protection and exceeds the following tests:
Human Body Model (HBM) ±2.0 kV per JEDEC standard: JESD22-A114.
Machine Model (MM) ±200 V per JEDEC standard: JESD22-A115.
- The maximum package power dissipation limit must not be exceeded.

$$P_D = \frac{T_{J(max)} - T_A}{R_{\theta JA}}$$

- Latchup Current Maximum Rating: ±150 mA per JEDEC standard: JESD78.
- Moisture Sensitivity Level: MSL 1 per IPC/JEDEC standard: J-STD-020A.
- Measured on approximately 1 in sq of 1 oz Cu.

NCP1423, SCV1423

ELECTRICAL CHARACTERISTICS

($V_{OUT} = 3.3\text{ V}$, $T_A = 25^\circ\text{C}$ for typical value, $-40^\circ\text{C} \leq T_A \leq 85^\circ\text{C}$ for min/max values unless otherwise noted.)

Characteristic	Symbol	Min	Typ	Max	Unit
Operating Voltage	V_{IN}	0.8	–	V_{OUT}	V
Output Voltage Range	V_{OUT}	1.8	–	3.3	V
Minimum Input Voltage for Startup	V_{IN_MIN}	–	0.85	0.90	V
Reference Voltage ($I_{LOAD} = 0\text{ mA}$, $C_{REF} = 100\text{ nF}$, $T_A = 25^\circ\text{C}$)	V_{REF}	1.177	1.195	1.213	V
Reference Voltage Temperature Coefficient	TC_{VREF}	–	0.05	–	mV/°C
FB Input Threshold ($I_{LOAD} = 0\text{ mA}$, $T_A = -40^\circ\text{C}$ to 85°C)	V_{FB}	0.489	0.500	0.512	V
FB Input Threshold ($I_{LOAD} = 0\text{ mA}$, $T_A = 25^\circ\text{C}$)	V_{FB}	0.493	0.500	0.508	V
FB Input Current	I_{FB}	–	1.0	–	nA
Internal NFET ON-Resistance ($I_{LX} = 100\text{ mA}$, $T_A = 25^\circ\text{C}$) (Note 7)	$R_{DS(ON)_N}$	–	0.3	0.45	Ω
Internal PFET ON-Resistance ($I_{LX} = 100\text{ mA}$, $T_A = 25^\circ\text{C}$) (Note 7)	$R_{DS(ON)_P}$	–	0.6	0.8	Ω
LX Switch Current Limit (NFET) (Note 7)	I_{LIM}	–	1.2	–	A
Operating Current into OUT ($V_{FB} = 0.7\text{ V}$, $T_A = 25^\circ\text{C}$)	I_Q	–	9.0	12	μA
Operating Current into BAT ($V_{BAT} = 1.2\text{ V}$, $V_{FB} = 0.7\text{ V}$, $V_{LX} = 1.2\text{ V}$, $T_A = 25^\circ\text{C}$)	I_{QBAT}	–	2.0	3.0	μA
Shutdown Current into BAT ($LBI/EN = 0\text{ V}$, $V_{BAT} = 3.3\text{ V}$, $T_A = 25^\circ\text{C}$)	I_{BAT_SD}	–	0.5	1.5	μA
LX Switch MAX. ON-Time ($V_{FB} = 0\text{ V}$)	t_{ON}	1.15	1.4	2.8	μs
LX Switch MIN. OFF-Time ($V_{FB} = 0\text{ V}$)	t_{OFF}	80	200	350	ns
BAT to LX Resistance ($V_{FB} = 0.7\text{ V}$)	R_{BAT_LX}	–	100	–	Ω
LBI Input Threshold	V_{LBI}	0.475	0.500	0.525	V
LBI Input Hysteresis	V_{LBI_HYS}	–	15	–	mV
LBI Input Current	I_{LBI}	–	1.5	–	nA
LBO Low Output Voltage ($V_{LBI} = 0\text{ V}$, $I_{SINK} = 1.0\text{ mA}$)	V_{LBO_L}	–	–	0.2	V
Maximum Continuous Output Current ($V_{IN} = 2.5\text{ V}$, $V_{OUT} = 3.3\text{ V}$) (Note 7)	I_{OUT}	200	–	–	mA
Maximum Continuous Output Current ($V_{IN} = 0.8\text{ V}$, $V_{OUT} = 3.3\text{ V}$) (Note 7)	I_{OUT}	100	–	–	mA
Soft Start Time ($V_{IN} = 1.2\text{ V}$, $T_A = 25^\circ\text{C}$, $C_{REF} = 100\text{ nF}$, $V_{OUT} = 3.3\text{ V}$) (Note 6)	T_{SS}	–	2.0	8.0	ms
EN Shutdown Threshold ($V_{BAT} = 1.2\text{ V}$)	V_{SHDN}	0.34	0.50	0.68	V
EN Input Current	I_{EN}	–	150	–	nA
ADEN Threshold ($V_{BAT} = 0.9\text{ V}$ to 3.3 V)	V_{ADEN}		$0.5 \cdot V_{BAT}$		V
ADEN Input Current	I_{ADEN}	–	100	–	nA
ADEN Switch Resistance	R_{ADEN}		100		Ω
Thermal Shutdown Temperature (Note 7)	T_{SHDN}	–	–	145	°C
Thermal Shutdown Hysteresis (Note 7)	T_{SDHYS}	–	30	–	°C

Product parametric performance is indicated in the Electrical Characteristics for the listed test conditions, unless otherwise noted. Product performance may not be indicated by the Electrical Characteristics if operated under different conditions.

6. Value depends on voltage at V_{OUT} .

7. Values are guaranteed by design.

NCP1423, SCV1423

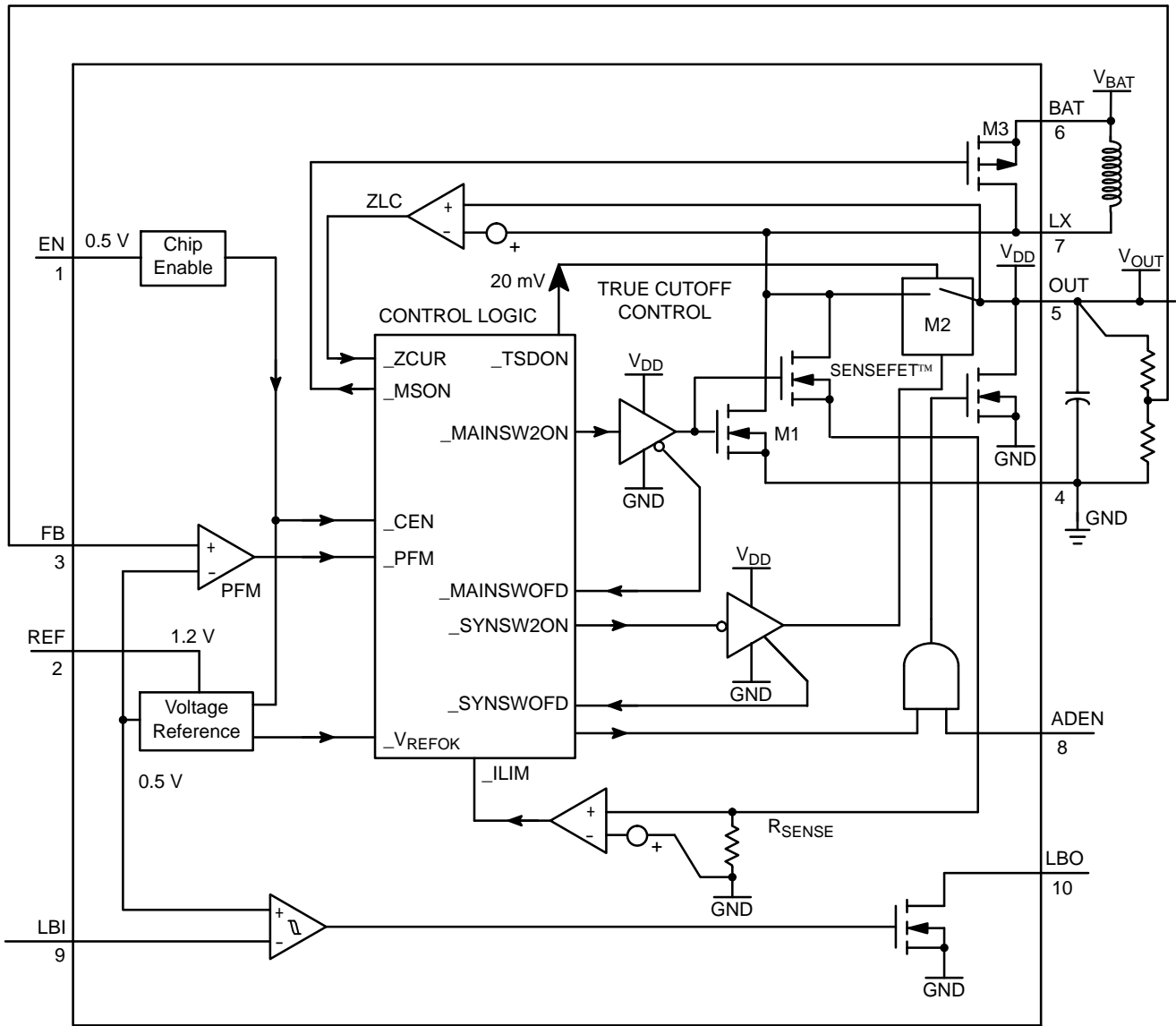

Figure 2. Detailed Block Diagram

TYPICAL OPERATING CHARACTERISTICS

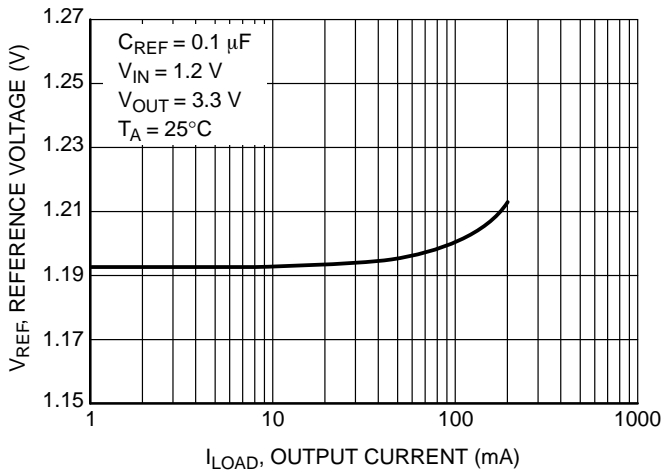

Figure 3. Reference Voltage vs. Output Current

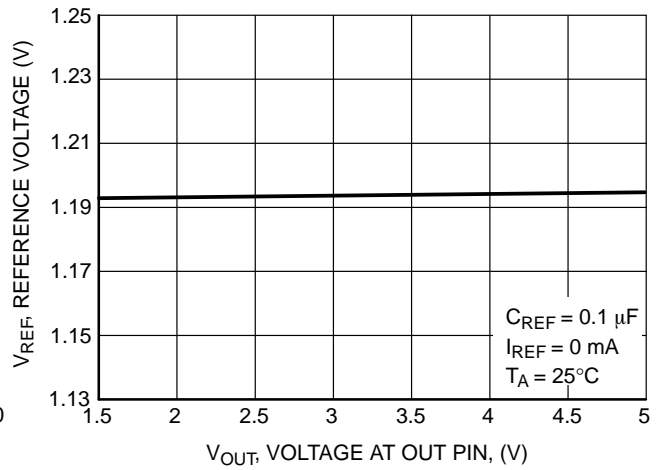

Figure 4. Reference Voltage vs. Voltage at OUT Pin

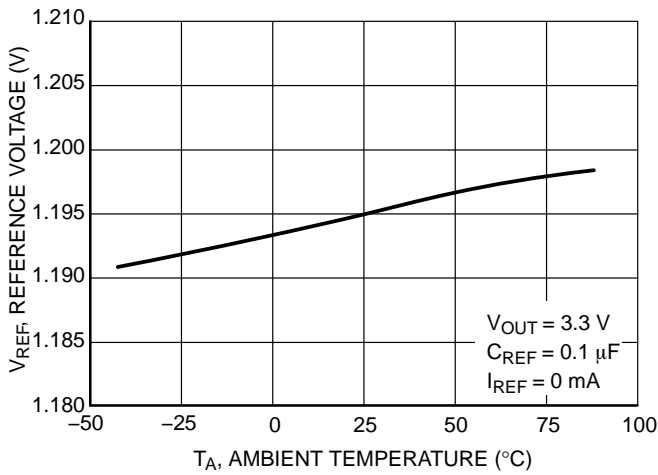

Figure 5. Reference Voltage vs. Temperature

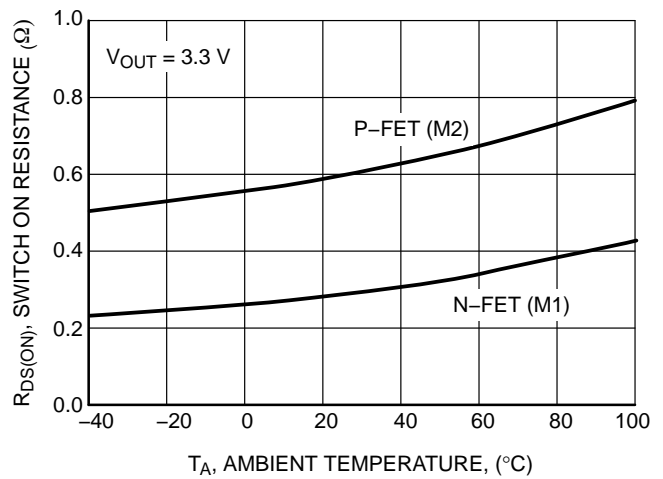

Figure 6. Switch ON Resistance vs. Temperature

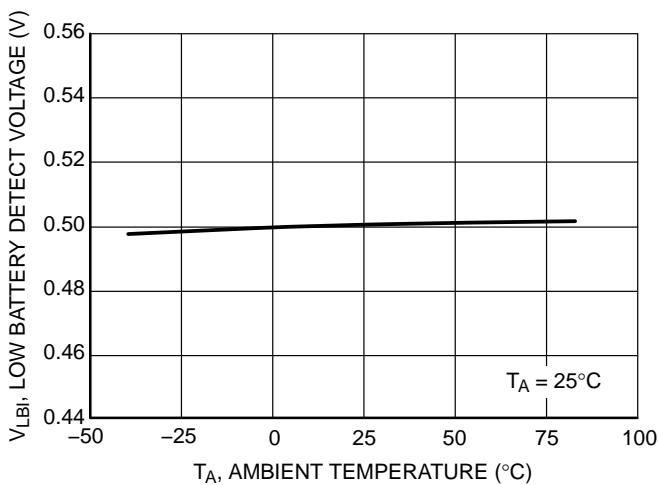

Figure 7. Low Battery Detect Voltage vs. Temperature

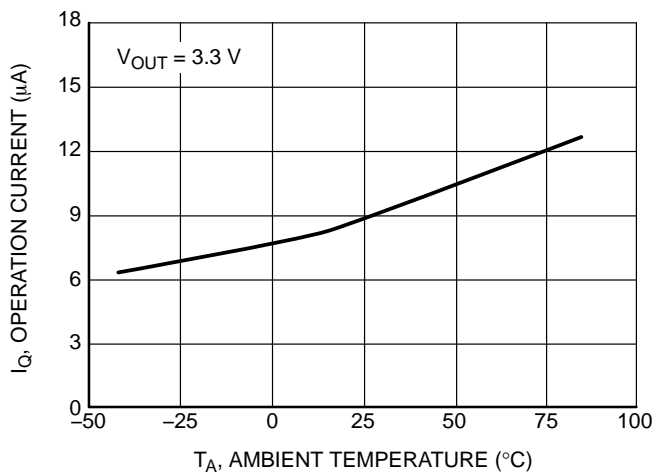

Figure 8. Operation Current vs. Temperature

TYPICAL OPERATING CHARACTERISTICS

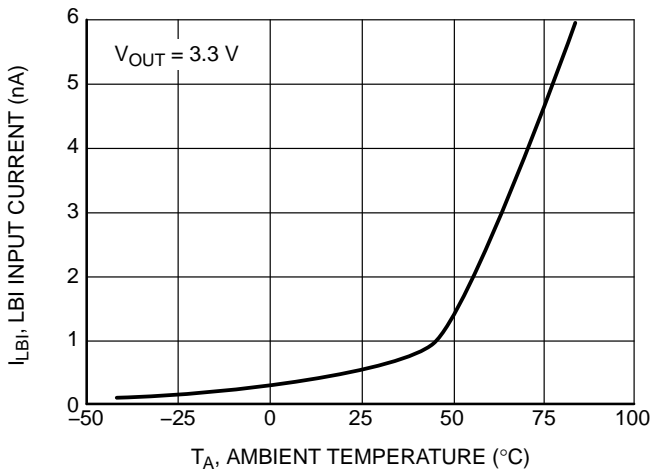

Figure 9. LBI Input Current vs. Temperature

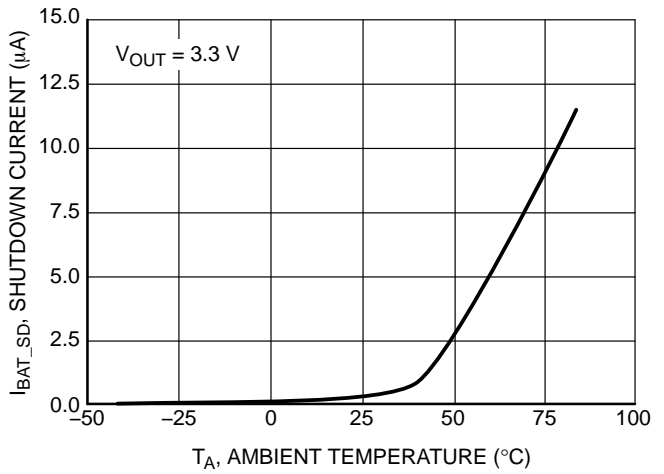

Figure 10. Shutdown Current vs. Temperature

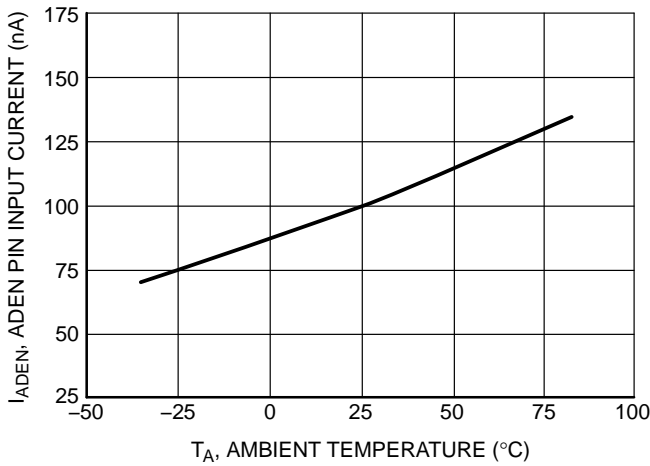

Figure 11. ADEN Pin Input Current vs. Temperature

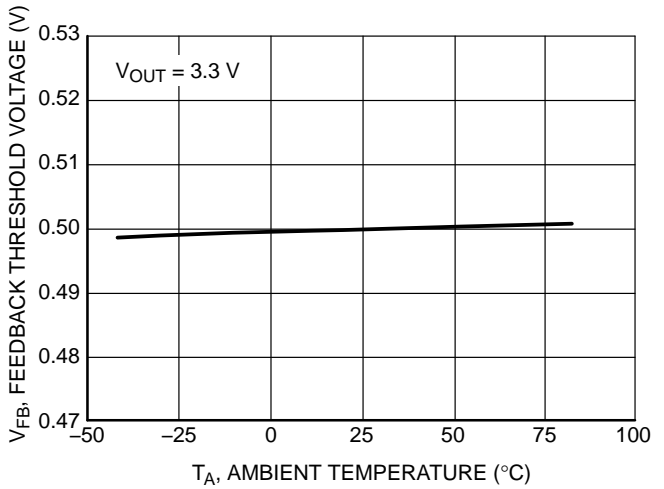

Figure 12. Feedback Threshold Voltage vs. Temperature

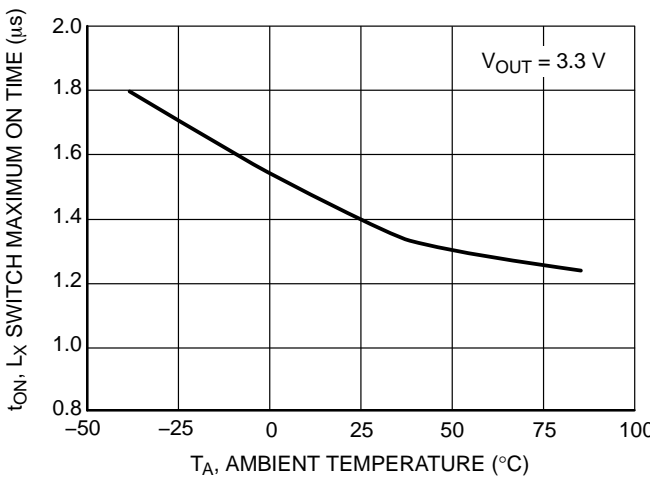

Figure 13. L_X Switch Maximum ON Time vs. Temperature

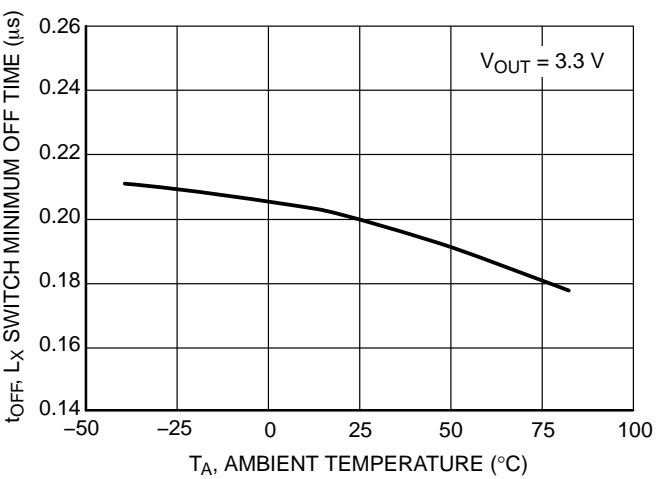

Figure 14. L_X Switch Minimum OFF Time vs. Temperature

TYPICAL OPERATING CHARACTERISTICS

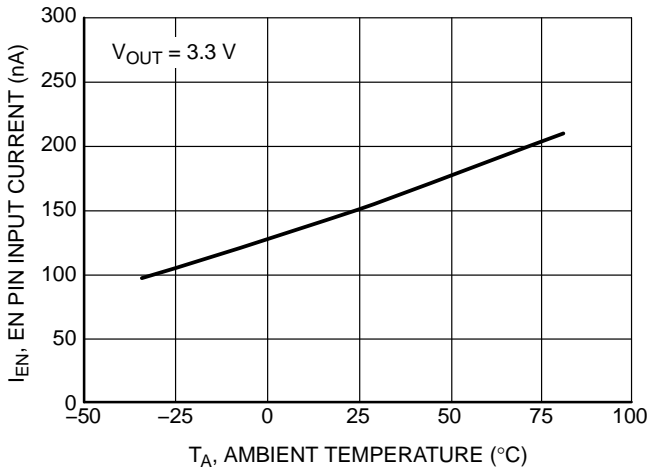

Figure 15. EN Input Current vs. Temperature

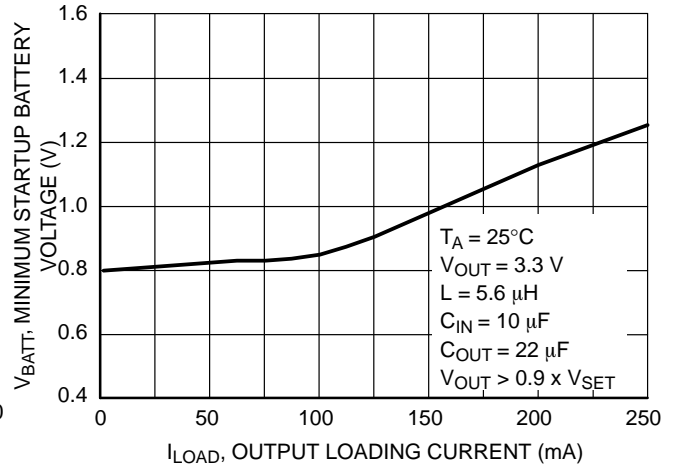

Figure 16. Minimum Startup Battery Voltage vs. Loading Current

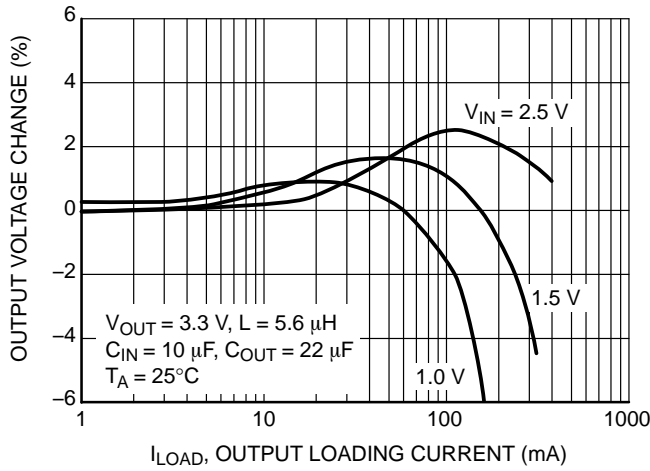

Figure 17. Output Voltage Change vs. Load Current

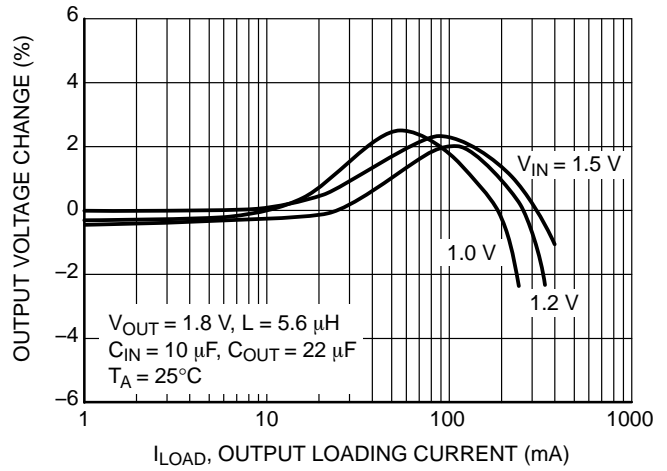

Figure 18. Output Voltage Change vs. Load Current

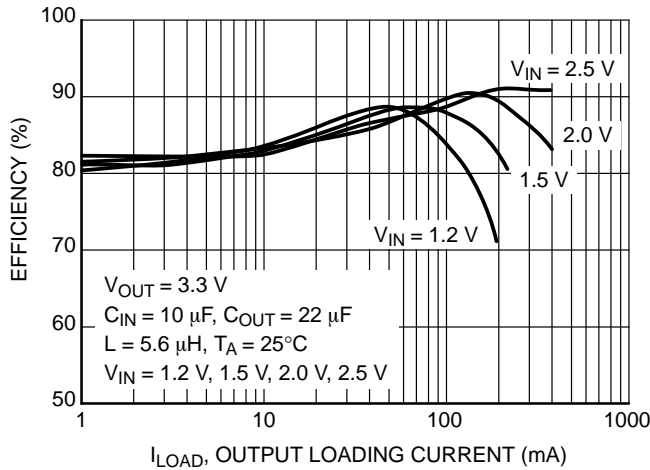

Figure 19. Efficiency vs. Load Current

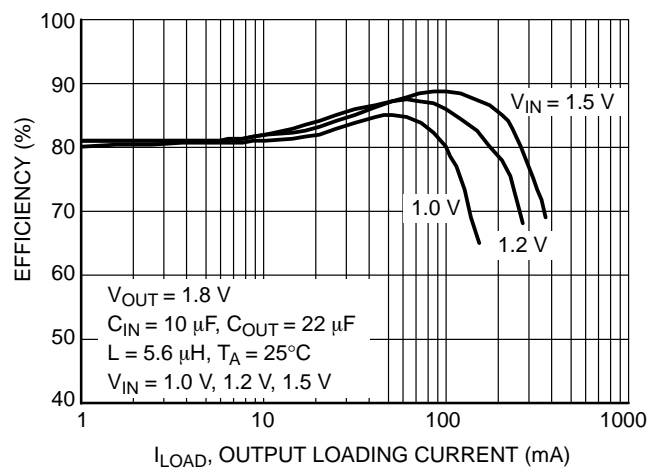

Figure 20. Efficiency vs. Load Current

TYPICAL OPERATING CHARACTERISTICS

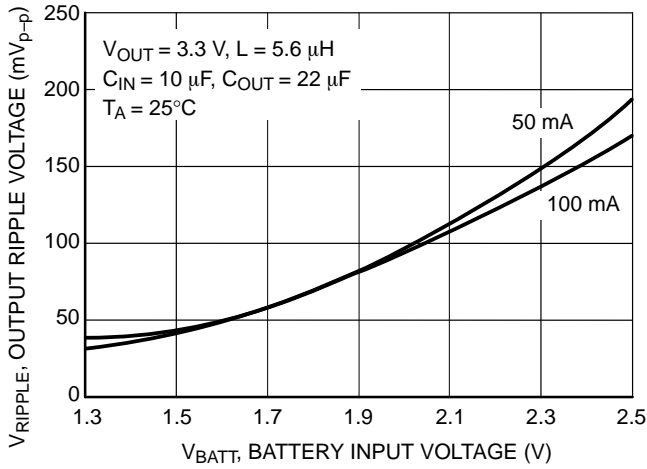

Figure 21. Output Ripple Voltage vs. Battery Input Voltage

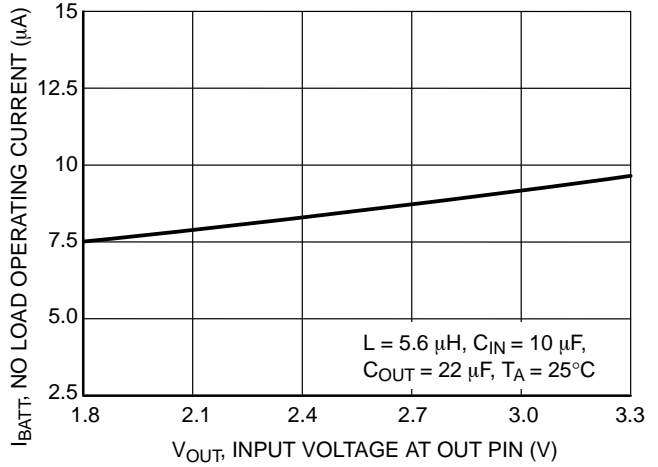
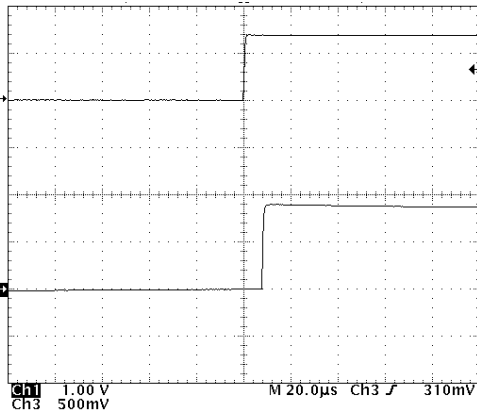
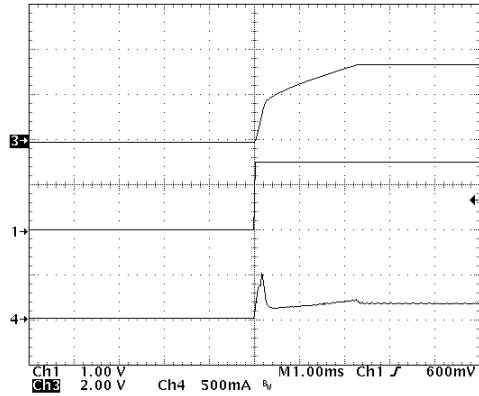

Figure 22. No Load Operating Current vs. Input Voltage at OUT Pin



Upper Trace: Voltage at LBI Pin, 0.5 V/Division
Lower Trace: Voltage at LBO Pin, 1.0 V/Division

Figure 23. Low Battery Detect



Upper Trace: Output Voltage Waveform, 2.0 V/Division
Middle Trace: Input Voltage Waveform, 1.0 V/Division
Lower Trace: Inductor Current Waveform, 500 mA/Division
($V_{IN} = 1.8\text{ V}$, $V_{OUT} = 3.3\text{ V}$, $L = 5.6\text{ μH}$, $I_{LOAD} = 60\text{ mA}$)

Figure 24. Startup Transient Response

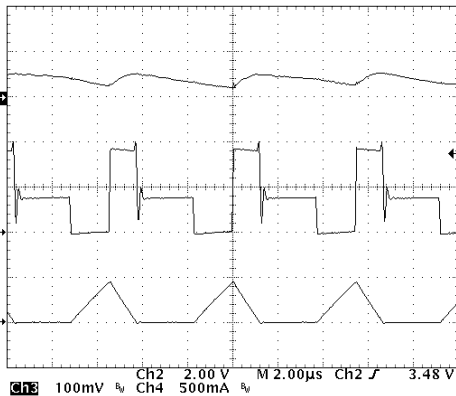

Upper Trace: Output Voltage Ripple, 100 mV/Division
Middle Trace: Voltage at Lx pin, 2.0 V/Division
Lower Trace: Inductor Current, 500 mA/Division
($V_{IN} = 1.5\text{ V}$, $V_{OUT} = 3.3\text{ V}$, $I_{LOAD} = 50\text{ mA}$; $L = 5.6\text{ μH}$, $C_{OUT} = 22\text{ μF}$)

Figure 25. Discontinuous Conduction Mode Switching Waveform

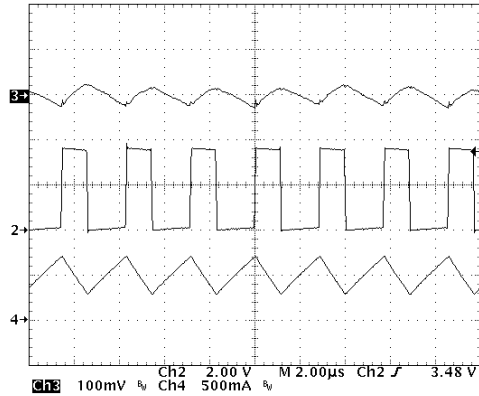

Upper Trace: Output Voltage Ripple, 100 mV/Division
Middle Trace: Voltage at LX pin, 2.0 V/Division
Lower Trace: Inductor Current, 500 mA/Division
($V_{IN} = 1.5\text{ V}$, $V_{OUT} = 3.3\text{ V}$, $I_{LOAD} = 200\text{ mA}$; $L = 5.6\text{ μH}$, $C_{OUT} = 22\text{ μF}$)

Figure 26. Continuous Conduction Mode Switching Waveform

TYPICAL OPERATING CHARACTERISTICS

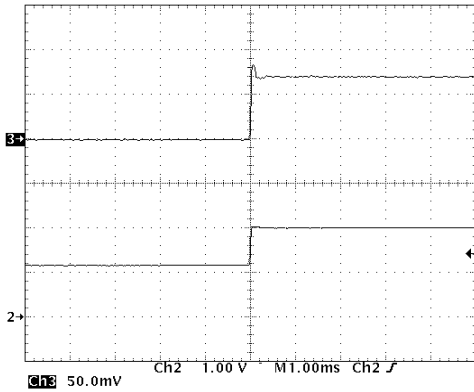

Upper Trace: Output Voltage Ripple, 50 mV/Division
 Lower Trace: Battery Voltage, V_{IN} , 1.0 V/Division
 ($V_{IN} = 1.2\text{ V to } 2.0\text{ V}$; $L = 5.6\ \mu\text{H}$, $C_{OUT} = 22\ \mu\text{F}$, $I_{LOAD} = 50\text{ mA}$)

Figure 27. Line Transient Response for $V_{OUT} = 3.3\text{ V}$

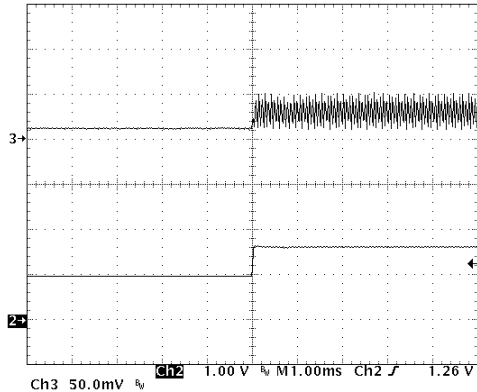

Upper Trace: Output Voltage Ripple, 50 mV/Division
 Lower Trace: Battery Voltage, V_{IN} , 1.0 V/Division
 ($V_{IN} = 1.0\text{ V to } 1.6\text{ V}$; $L = 5.6\ \mu\text{H}$, $C_{OUT} = 22\ \mu\text{F}$, $I_{LOAD} = 50\text{ mA}$)

Figure 28. Line Transient Response For $V_{OUT} = 1.8\text{ V}$

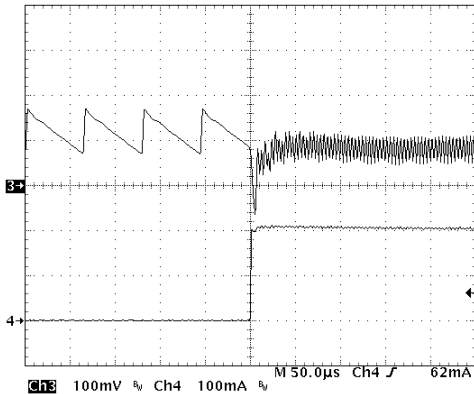

Upper Trace: Output Voltage Ripple, 100 mV/Division
 Lower Trace: Load Current, I_{LOAD} , 100 mA/Division
 ($V_{OUT} = 3.3\text{ V}$, $I_{LOAD} = 10\text{ mA to } 200\text{ mA}$; $L = 5.6\ \mu\text{H}$, $C_{OUT} = 22\ \mu\text{F}$)

Figure 29. Load Transient Response For $V_{IN} = 1.5\text{ V}$

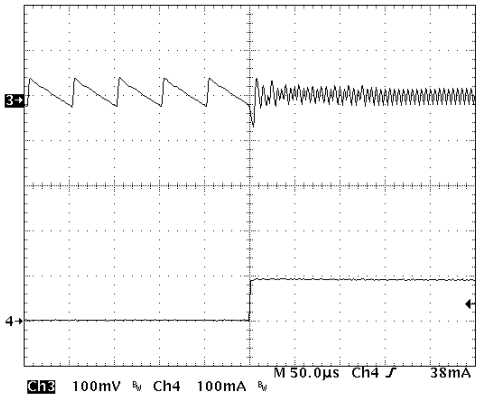

Upper Trace: Output Voltage Ripple, 100 mV/Division
 Lower Trace: Load Current, I_{LOAD} , 100 mA/Division
 ($V_{OUT} = 1.8\text{ V}$, $I_{LOAD} = 10\text{ mA to } 100\text{ mA}$; $L = 5.6\ \mu\text{H}$, $C_{OUT} = 22\ \mu\text{F}$)

Figure 30. Load Transient Response For $V_{IN} = 1.0\text{ V}$

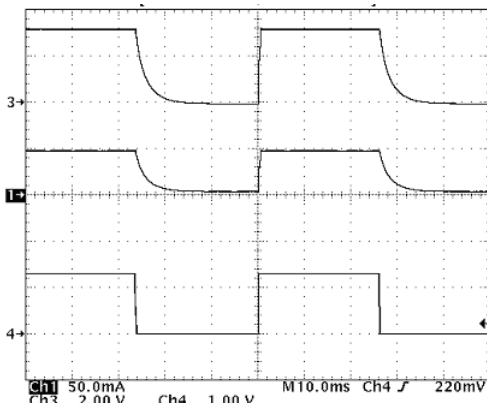

Upper Trace: Output Voltage, 2.0 V/Division
 Lower Trace: Output Current, 50 mA/Division
 Middle Trace: Enable Pin Waveform, 1.0 V/Division
 ($V_{IN} = 1.5\text{ V}$, $V_{OUT} = 3.3\text{ V}$, $L = 5.6\ \mu\text{H}$, $C_{IN} = 10\ \mu\text{F}$, $C_{OUT} = 22\ \mu\text{F}$)

Figure 31. Startup Waveform (ADEN Disabled)

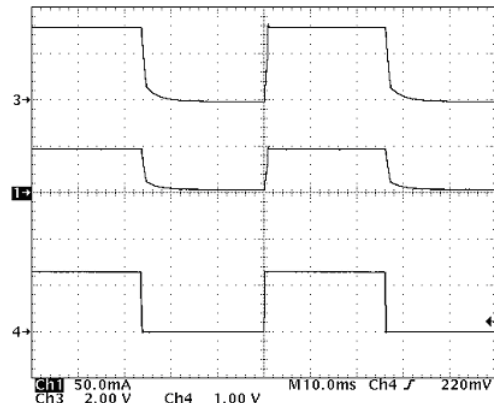

Upper Trace: Output Voltage, 2.0 V/Division
 Lower Trace: Output Current, 50 mA/Division
 Middle Trace: Enable Pin Waveform, 1.0 V/Division
 ($V_{IN} = 1.5\text{ V}$, $V_{OUT} = 3.3\text{ V}$, $L = 5.6\ \mu\text{H}$, $C_{IN} = 10\ \mu\text{F}$, $C_{OUT} = 22\ \mu\text{F}$)

Figure 32. Startup Waveform (ADEN Enabled)

DETAILED OPERATION DESCRIPTION

NCP1423 is a monolithic micropower high-frequency step-up voltage switching converter IC specially designed for battery operated hand-held electronic products up to 200 mA loading. It integrates a Synchronous Rectifier to improve efficiency as well as to eliminate the external Schottky diode. High switching frequency (up to 600 kHz) allows for a low profile inductor and output capacitor to be used. Low-Battery Detector, Logic-Controlled Shutdown and Cycle-by-Cycle Current Limit provide value-added features for various battery-operated applications. With all these functions ON, the quiescent supply current is typical only 9 μ A. This device is available in compact Micro10 package.

PFM Regulation Scheme

From the detailed block diagram (Figure 2), the output voltage is divided down and fed back to Pin 3 (FB). This voltage goes to the non-inverting input of the PFM comparator whereas the comparator's inverting input is connected to the internal voltage reference, REF. A switching cycle is initiated by the falling edge of the comparator, at the moment the main switch (M1) is turned ON. After the maximum ON-time (typical 1.4 μ S) elapses or the current limit is reached, M1 is turned OFF, and the synchronous switch (M2) is turned ON. The M1 OFF time is not less than the minimum OFF-time (typically 0.20 μ S), which ensure complete energy transfer from the inductor to the output capacitor. If the regulator is operating in continuous conduction mode (CCM), M2 is turned OFF just before M1 is supposed to be ON again. If the regulator is operating in discontinuous conduction mode (DCM), which means the coil current will decrease to zero before the new cycle start, M1 is turned OFF as the coil current is almost reaching zero. The comparator (ZLC) with fixed offset is dedicated to sense the voltage drop across M2 as it is conducting, when the voltage drop is below the offset, the ZLC comparator output goes HIGH, and M2 is turned OFF. Negative feedback of closed loop operation regulates voltage at Pin 3 (FB) equal to the internal divide down reference voltage times (0.5 V).

Synchronous Rectification

The Synchronous Rectifier is used to replace the Schottky Diode to reduce the conduction loss contributed by the forward voltage of the Schottky Diode. The Synchronous Rectifier is normally realized by PowerFET with gate control circuitry that incorporates relatively complicated timing concerns.

As the main switch (M1) is being turned OFF and the synchronous switch M2 is just turned ON with M1 not being completely turned OFF, current is shunt from the output bulk capacitor through M2 and M1 to ground. This power loss lowers overall efficiency and possibly damage the switching FETs. As a general practice, certain amount of dead time is

introduced to make sure M1 is completely turned OFF before M2 is being turned ON.

The previously mentioned situation occurs when the regulator is operating in CCM, M2 is being turned OFF, M1 is just turned ON, and M2 is not being completely turned OFF. A dead time is also needed to make sure M2 is completely turned OFF before M1 is being turned ON.

As coil current is dropped to zero when the regulator is operating in DCM, M2 should be OFF. If this does not occur, the reverse current flows from the output bulk capacitor through M2 and the inductor to the battery input, causing damage to the battery. The ZLC comparator comes with fixed offset voltage to switch M2 OFF before any reverse current builds up. However, if M2 switch OFF too early, large residue coil current flows through the body diode of M2 and increases conduction loss. Therefore, determination on the offset voltage is essential for optimum performance. With the implementation of synchronous rectification scheme, efficiency can be as high as 90% with this device.

Cycle-by-Cycle Current Limit

In Figure 2, SENSEFET is used to sample the coil current as M1 is ON. With that sample current flowing through a sense resistor, a sense-voltage is developed. Threshold detector (I_{LIM}) detects whether the sense-voltage is higher than the preset level. If the sense voltage is higher than the present level, the detector output notifies the Control Logic to switch OFF M1, and M1 can only be switched ON when the next cycle starts after the minimum OFF-time (typically 0.20 μ S). With proper sizing of SENSEFET and sense resistor, the peak coil current limit is typically set at 1.2 A.

Voltage Reference

The voltage at REF is typically set at 1.2 V and can output up to 2.5 mA with load regulation $\pm 2.0\%$, at V_{OUT} equal to 3.3 V. If V_{OUT} is increased, the REF load capability can also be increased. A bypass capacitor of 200 nF is required for proper operation when REF is not loaded. If REF is loaded, 1.0 μ F capacitor at REF pin is needed.

True-Cutoff

The NCP1423 has a True-Cutoff function controlled by the EN pin (Pin 1). Internal circuitry can isolate the current through the body diode of switch M2 to load. Thus, it can eliminate leakage current from the battery to load in shutdown mode and significantly reduces battery current consumption during shutdown. The shutdown function is controlled by the voltage at Pin 1 (EN). When Pin 1 is pulled to lower than 0.5 V, the controller enters shutdown mode. In shutdown mode, when the switches M1 and M2 are both switched OFF, the internal reference voltage of the controller is disable and the controller typically consumes only 600 nA of current. If the Pin 1 voltage is raised to higher than 0.5 V, for example, by a resistor connected to V_{IN} , the

IC is enabled again, and the internal circuit typically consumes 9 μ A of current from the OUT pin during normal operation.

Low-Battery Detection

A comparator with 15 mV hysteresis is applied to perform the low-battery detection function. When Pin 9 (LBI) is at a voltage (defined by a resistor divider from the battery voltage) lower than the internal reference voltage of 0.5 V, the comparator output turns on a 50 Ω low side switch. It pulls down the voltage at Pin 10 (LBO) which requires a hundred to a thousand k Ω of external pull-high resistance. If the Pin 9 voltage is higher than 0.5 V+15 mV, the

comparator output turns off the 50 Ω low side switch. When this occurs, Pin 10 becomes high impedance and its voltage is pulled high again.

Auto Discharge

Auto discharge function is used to ensure the output voltage status after the power down occurs. This function is used for communication with a digital signal. When auto discharge function is enabled, the ADEN is set high; the output capacitor will be discharged after the device is shutdown. The capacitors connected to the output are discharged by an integrated switch of 100 Ω . The residual voltage on V_{OUT} will be less than 0.4 V after auto discharge.

APPLICATIONS INFORMATION

Output Voltage Setting

A typical application circuit is shown in Figure 1. The output voltage of the converter is determined by the external feedback network comprised of R1 and R2 and the relationship is given by:

$$V_{OUT} = 0.5 \text{ V} \times \left(1 + \frac{R1}{R2} \right)$$

where R1 and R2 are the upper and lower feedback resistors, respectively.

Low Battery Detect Level Setting

The Low Battery Detect Voltage of the converter is determined by the external divider network comprised of R3 and R4 and the relationship is given by:

$$V_{LBI} = 0.5 \text{ V} \times \left(1 + \frac{R3}{R4} \right)$$

where R3 and R4 are the upper and lower divider resistors respectively.

Inductor Selection

The NCP1423 is tested to produce optimum performance with a 5.6 μ H inductor at V_{IN} = 1.3 V, V_{OUT} = 3.3 V, supplying an output current up to 200 mA. For other input / output requirements, inductance in the range 3 μ H to 10 μ H can be used according to end application specifications. Selecting an inductor is a compromise between output current capability, inductor saturation limit and tolerable output voltage ripple. Low inductance values can supply higher output current but also increase the ripple at output and decrease efficiency. On the other hand, high inductance values can improve output ripple and efficiency; however, it also limited the output current capability at the same time.

Another parameter of the inductor is its DC resistance. This resistance can introduce unwanted power loss and reduce overall efficiency. The basic rule is to select an inductor with lowest DC resistance within the board space limitation of the end application.

Capacitors Selection

In all switching mode boost converter applications, both the input and output terminals see impulsive voltage / current waveforms. The currents flowing into and out of the capacitors multiply with the Equivalent Series Resistance (ESR) of the capacitor to produce ripple voltage at the terminals. During the Syn-Rect switch-off cycle, the charges stored in the output capacitor are used to sustain the output load current. Load current at this period and the ESR combined and reflect as ripple at the output terminals. For all cases, the lower the capacitor ESR, the lower the ripple voltage at output. As a general guideline, low ESR capacitors should be used.

PCB Layout Recommendations

Good PCB layout plays an important role in switching mode power conversion. Careful PCB layout can help to minimize ground bounce, EMI noise, and unwanted feedback that can affect the performance of the converter. Hints suggested below can be used as a guideline in most situations.

Grounding

A star-ground connection should be used to connect the output power return ground, the input power return ground, and the device power ground together at one point. All high-current paths must be as short as possible and thick enough to allow current to flow through and produce insignificant voltage drop along the path. The feedback signal path must be separated from the main current path and sense directly at the anode of the output capacitor.

Components Placement

Power components (i.e. input capacitor, inductor and output capacitor) must be placed as close together as possible. All connecting traces must be short, direct and thick. High current flowing and switching paths must be kept away from the feedback (FB, Pin 3) terminal to avoid unwanted injection of noise into the feedback path.

LAYOUT GUIDELINES

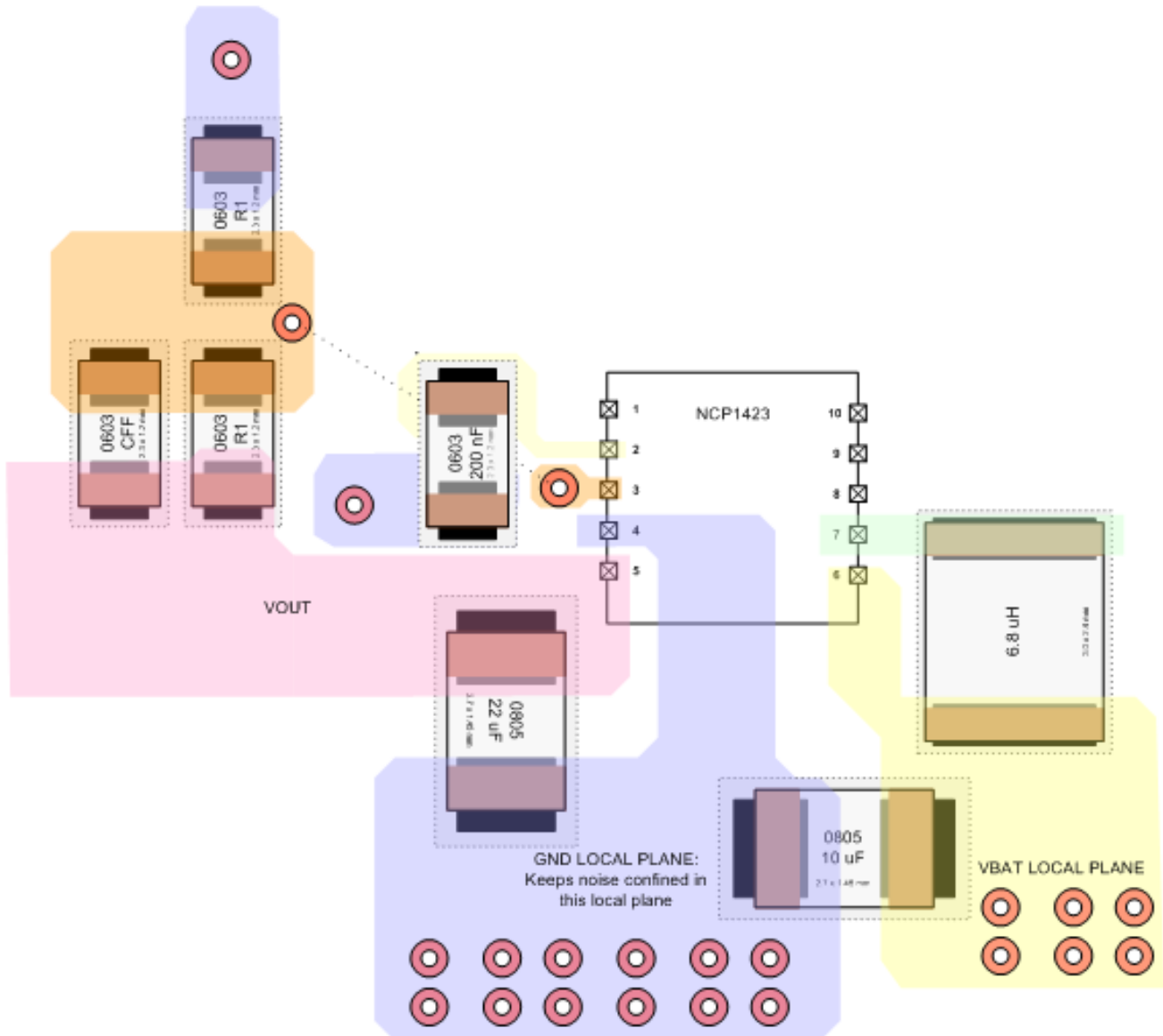

Figure 33. Layout Guidelines

General Design Procedures

Switching mode converter design is important. Suitable choice an inductor and capacitor value can make the converter has an optimum performance. Below a simple method base on the most basic first order equations to estimate the inductor and capacitor values for NCP1423 operate in Continuous Conduction Mode (CCM) is introduced. The component value set can be used as a starting point to fine-tune the circuit operation. By all means, detail bench testing is needed to get the best performance out of the circuit.

Design Parameters:

For one cells supply application

- $V_{IN} = 1.1 \text{ V to } 1.5 \text{ V, Typical } 1.3 \text{ V}$
- $V_{OUT} = 3.3 \text{ V}$
- $I_{OUT} = 150 \text{ mA (200 mA max)}$
- $V_{LB} = 1.0 \text{ V}$
- $V_{OUT-RIPPLE} = 30 \text{ mV}_{P-P}$ at $I_{OUT} = 150 \text{ mA}$

Calculate the feedback network:

Select $R_2 = 100 \text{ k}$

$$R_1 = R_2 \left(\frac{V_{OUT}}{V_{FB}} - 1 \right)$$

$$R_1 = 100 \text{ k} \left(\frac{3.3 \text{ V}}{0.5 \text{ V}} - 1 \right) = 560 \text{ k}$$

Calculate the Low Battery Detect divider:

- $V_{LB0} = 1.0 \text{ V}$
- Select $R_4 = 100 \text{ k}$

$$R_3 = R_4 \left(\frac{V_{LB0}}{V_{LB1}} - 1 \right)$$

$$R_3 = 100 \text{ k} \left(\frac{1.0 \text{ V}}{0.5 \text{ V}} - 1 \right) = 100 \text{ k}$$

Determine the steady state duty ratio, D for typical V_{IN} , operation will be optimized around this point:

$$\frac{V_{OUT}}{V_{IN}} = \frac{1}{1 - D}$$

$$D = 1 - \frac{V_{IN}}{V_{OUT}} = 1 - \frac{1.3 \text{ V}}{3.3 \text{ V}} = 0.606$$

Determine the average inductor current, I_{LAVG} at maximum I_{OUT} :

$$I_{LAVG} = \frac{I_{OUT}}{1 - D} = \frac{150 \text{ mA}}{1 - 0.606} = 381 \text{ mA}$$

Assume the efficiency $\eta = 85\%$

Determine the peak inductor ripple current, $I_{RIPPLE-P}$ and calculate the inductor value:

Assume $I_{RIPPLE-P}$ is 40% of I_{LAVG} , the inductance of the power inductor can be calculated as in below:

$$I_{RIPPLE-P} = 0.40 \times 381 \text{ mA} / \eta = 179 \text{ mA}$$

$$L = \frac{V_{IN} \times t_{ON}}{2 I_{RIPPLE-P}} = \frac{1.3 \text{ V} \times 1.4 \mu\text{S}}{2 (179 \text{ mA})} = 5.0 \mu\text{H}$$

A standard value of 5.6 μH is selected for initial trial.

Determine the output voltage ripple, $V_{OUT-RIPPLE}$ and calculate the output capacitor value:

$$V_{OUT-RIPPLE} = 30 \text{ mV}_{P-P}$$

$$C_{OUT} > \frac{I_{OUT} \times t_{ON}}{V_{OUT-RIPPLE} - I_{OUT} \times ESR_{COUT}}$$

where $t_{ON} = 1.4 \mu\text{S}$ and $ESR_{COUT} = 0.1 \Omega$,

From above calculation, you need at least 14 μF in order to achieve the specified ripple level at conditions stated. Practically, a one level larger capacitor will be used to accommodate factors not taken into account in the calculations. Therefore, a capacitor value of 22 μF is selected. The NCP1423 is internal compensated for most applications. But in case additional compensation is required, the capacitor C1 can be used as external compensation adjustment to improve system dynamics.

Feedforward Capacitor (C1) Selection

A feedforward capacitor might be required to be added in parallel to the upper feedback resistor to avoid double pulsing or group pulsing at the switching node which causes larger inductor ripple current and higher output voltage ripple. With adequate feedforward capacitor, evenly distributed single pulses at the switching node can be achieved. For NCP1423, the lower the switching frequency is, the larger the feedforward capacitor value should be. For initial trial value, the following equation can be used, but actual value may need fine tuning:

$$C_{FF} \approx \frac{1}{2 \times \pi \times \frac{F_{SW}}{20} \times R_1}$$

F_{SW} is the switching frequency measured for nominal load. If a feedforward capacitor is used, the equation provides an initial starting value. Some trimming of the feedback capacitor may be required depending on the desired output value.

NCP1423, SCV1423

PACKAGE DIMENSIONS

Micro10
CASE 846B-03
ISSUE D

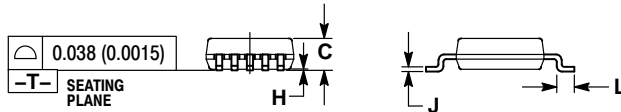
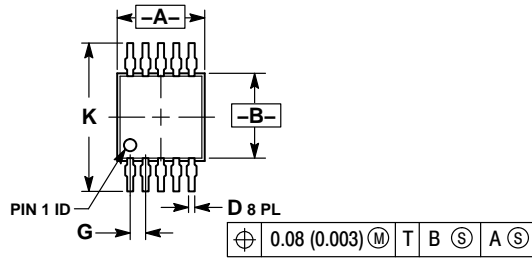

NOTES:

1. DIMENSIONING AND TOLERANCING PER ANSI Y14.5M, 1982.
2. CONTROLLING DIMENSION: MILLIMETER.
3. DIMENSION "A" DOES NOT INCLUDE MOLD FLASH, PROTRUSIONS OR GATE BURRS. MOLD FLASH, PROTRUSIONS OR GATE BURRS SHALL NOT EXCEED 0.15 (0.006) PER SIDE.
4. DIMENSION "B" DOES NOT INCLUDE INTERLEAD FLASH OR PROTRUSION. INTERLEAD FLASH OR PROTRUSION SHALL NOT EXCEED 0.25 (0.010) PER SIDE.
5. 846B-01 OBSOLETE. NEW STANDARD 846B-02

DIM	MILLIMETERS		INCHES	
	MIN	MAX	MIN	MAX
A	2.90	3.10	0.114	0.122
B	2.90	3.10	0.114	0.122
C	0.95	1.10	0.037	0.043
D	0.20	0.30	0.008	0.012
G	0.50 BSC		0.020 BSC	
H	0.05	0.15	0.002	0.006
J	0.10	0.21	0.004	0.008
K	4.75	5.05	0.187	0.199
L	0.40	0.70	0.016	0.028

SOLDERING FOOTPRINT*

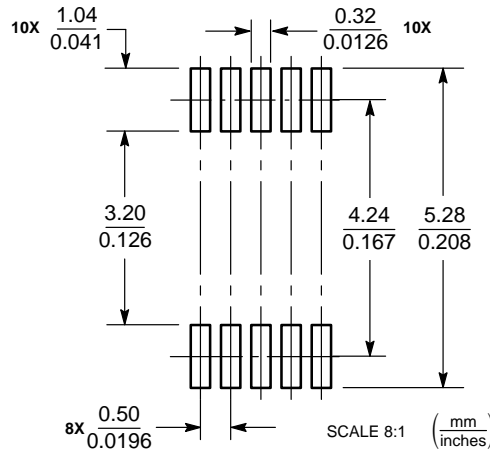

*For additional information on our Pb-Free strategy and soldering details, please download the ON Semiconductor Soldering and Mounting Techniques Reference Manual, SOLDERRM/D.

SENSEFET is a trademark of Semiconductor Components Industries, LLC.

ON Semiconductor and are registered trademarks of Semiconductor Components Industries, LLC (SCILLC). SCILLC owns the rights to a number of patents, trademarks, copyrights, trade secrets, and other intellectual property. A listing of SCILLC's product/patent coverage may be accessed at www.onsemi.com/site/pdf/Patent-Marking.pdf. SCILLC reserves the right to make changes without further notice to any products herein. SCILLC makes no warranty, representation or guarantee regarding the suitability of its products for any particular purpose, nor does SCILLC assume any liability arising out of the application or use of any product or circuit, and specifically disclaims any and all liability, including without limitation special, consequential or incidental damages. "Typical" parameters which may be provided in SCILLC data sheets and/or specifications can and do vary in different applications and actual performance may vary over time. All operating parameters, including "Typicals" must be validated for each customer application by customer's technical experts. SCILLC does not convey any license under its patent rights nor the rights of others. SCILLC products are not designed, intended, or authorized for use as components in systems intended for surgical implant into the body, or other applications intended to support or sustain life, or for any other application in which the failure of the SCILLC product could create a situation where personal injury or death may occur. Should Buyer purchase or use SCILLC products for any such unintended or unauthorized application, Buyer shall indemnify and hold SCILLC and its officers, employees, subsidiaries, affiliates, and distributors harmless against all claims, costs, damages, and expenses, and reasonable attorney fees arising out of, directly or indirectly, any claim of personal injury or death associated with such unintended or unauthorized use, even if such claim alleges that SCILLC was negligent regarding the design or manufacture of the part. SCILLC is an Equal Opportunity/Affirmative Action Employer. This literature is subject to all applicable copyright laws and is not for resale in any manner.

PUBLICATION ORDERING INFORMATION

LITERATURE FULFILLMENT:
Literature Distribution Center for ON Semiconductor
P.O. Box 5163, Denver, Colorado 80217 USA
Phone: 303-675-2175 or 800-344-3860 Toll Free USA/Canada
Fax: 303-675-2176 or 800-344-3867 Toll Free USA/Canada
Email: orderlit@onsemi.com

N. American Technical Support: 800-282-9855 Toll Free
USA/Canada
Europe, Middle East and Africa Technical Support:
Phone: 421 33 790 2910
Japan Customer Focus Center
Phone: 81-3-5817-1050

ON Semiconductor Website: www.onsemi.com
Order Literature: <http://www.onsemi.com/orderlit>
For additional information, please contact your local Sales Representative