

High Power Bi-Directional Coupler

SYBD-10-63HP+

50Ω 10dB Coupling DC Pass 2700 to 6000 MHz



CASE STYLE: JB1233

+RoHS Compliant

The +Suffix identifies RoHS Compliance. See our web site for RoHS Compliance methodologies and qualifications

Maximum Ratings

Operating Temperature	-55°C to 100°C
Storage Temperature	-55°C to 100°C
DC Current	2A

Permanent damage may occur if any of these limits are exceeded.

Pin Connections

INPUT	1
OUTPUT	2
COUPLED (forward)	4
COUPLED (reverse)	3
GROUND	5

Outline Drawing

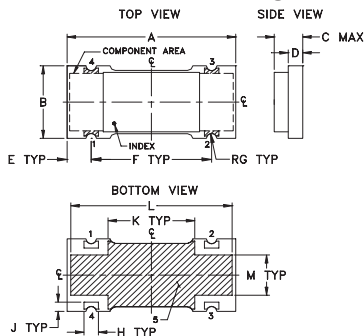

PCB Land Pattern

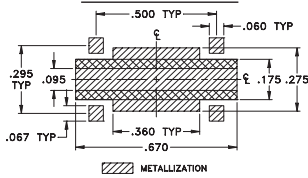

Suggested Layout,
Tolerance to be within ±0.02

Outline Dimensions (inch/mm)

A	B	C	D	E	F	G
.70	.32	.13	.060	.100	.500	.022
17.78	8.13	3.30	1.52	2.54	12.70	0.56
H	J	K	L	M		wt
.060	.040	.360	.670	.175		grams
1.52	1.02	9.14	17.02	4.45		0.68

Demo Board MCL P/N: TB-398 Suggested PCB Layout (PL-260)

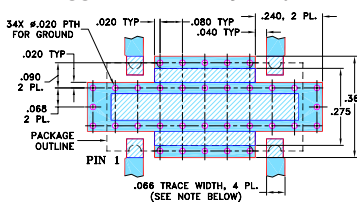

- NOTES: 1. TRACE WIDTH IS SHOWN FOR ROGERS RO4350B WITH DIELECTRIC THICKNESS .030" ± .002"; COPPER: 1/2 OZ. EACH SIDE. FOR OTHER MATERIALS TRACE WIDTH MAY NEED TO BE MODIFIED.
2. BOTTOM SIDE OF THE PCB IS CONTINUOUS GROUND PLANE.
3. DENOTES PCB COPPER LAYOUT WITH SMOBC (SOLDER MASK OVER BARE COPPER)
4. DENOTES COPPER LAND PATTERN FREE OF SOLDER MASK

Notes

- A. Performance and quality attributes and conditions not expressly stated in this specification document are intended to be excluded and do not form a part of this specification document.
B. Electrical specifications and performance data contained in this specification document are based on Mini-Circuit's applicable established test performance criteria and measurement instructions.
C. The parts covered by this specification document are subject to Mini-Circuit's standard limited warranty and terms and conditions (collectively, "Standard Terms"); Purchasers of this part are entitled to the rights and benefits contained therein. For a full statement of the Standard Terms and the exclusive rights and remedies thereunder, please visit Mini-Circuit's website at www.minicircuits.com/WCLStore/terms.jsp

Features

- high power handling, 25 watts typ.
- low mainline loss, 0.45 dB typ.
- excellent VSWR, 1.1:1 typ.
- excellent directivity 23 dB typ.
- wideband frequency, 2700 to 6000 MHz

Applications

- instrumentation
- ISM
- defense communications
- federal communications
- fixed satellite

Electrical Specifications

FREQ. (MHz)	COUPLING (dB)		MAINLINE LOSS ¹ (dB)		DIRECTIVITY (dB)		VSWR (:1)	POWER INPUT (W)
	Nom.	Flatness	Typ.	Max.	Typ.	Min.		
$f_c - f_u$								
2700-6000			0.60	1.2	20	10	1.2	
2700-3000	12.5±0.8	±0.5	0.40	0.8	23	16	1.1	25
3000-3600	11.8±0.8	±0.7	0.45	0.9	23	15	1.1	25
3600-4500	10.8±0.7	±0.6	0.60	1.0	22	12	1.2	20
4500-6000	10.3±0.8	±0.4	0.75	1.2	18	10	1.3	20

1. Mainline loss includes theoretical power loss at coupled port.

Typical Performance Data

Frequency (MHz)	Mainline Loss (dB)	Coupling (dB)		Directivity (dB)		Return Loss (dB)			
		In-Out	In-Cpl Fwd	Out-Cpl Rev	Out-Cpl Fwd	In-Cpl Rev	In	Out	Cpl Fwd
2700.00	0.35	12.96	13.00	23.92	23.33	30.45	30.13	28.13	28.18
3000.00	0.38	12.32	12.36	24.54	23.46	37.16	33.07	27.19	26.71
3400.00	0.44	11.63	11.65	23.99	23.10	39.27	31.87	26.78	26.40
3600.00	0.48	11.35	11.35	23.67	23.18	33.94	30.12	28.04	27.32
4200.00	0.58	10.67	10.71	22.27	22.08	25.61	24.84	40.53	33.13
4500.00	0.64	10.47	10.52	21.14	21.30	22.64	22.47	31.66	31.56
5000.00	0.72	10.31	10.36	19.25	20.96	19.70	19.86	26.55	27.23
5400.00	0.75	10.28	10.33	18.12	20.58	18.31	18.68	24.22	24.29
5800.00	0.78	10.31	10.37	17.26	18.56	16.33	16.77	21.49	21.52
6000.00	0.83	10.37	10.44	16.76	17.05	15.43	15.44	20.24	20.22

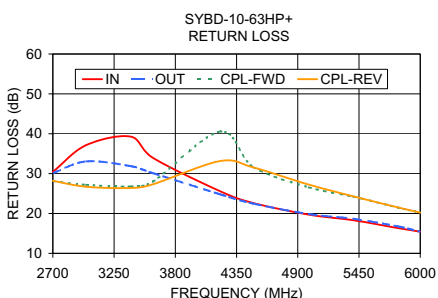
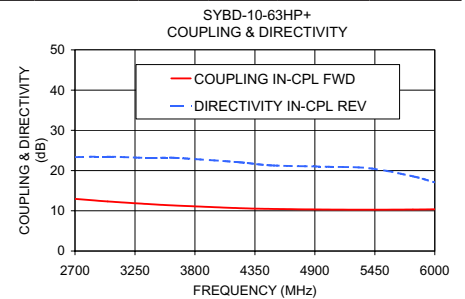
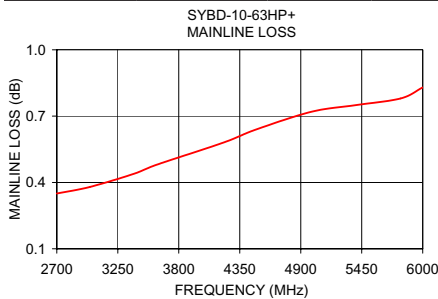

Electrical Schematic

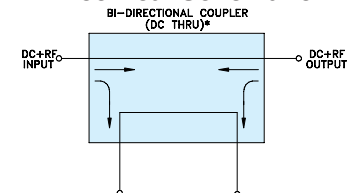

* ELECTRICAL SCHEMATIC IS FOR BI-DIRECTIONAL COUPLER WITHOUT INTERNAL TRANSFORMERS AND RESISTORS.

