

## PHASE CONTROL THYRISTOR

# AT980

Repetitive voltage up to **6000 V**

Mean forward current **2680 A**

Surge current **50 kA**

### FINAL SPECIFICATION

Feb. 17 - Issue: 6

Symbol	Characteristic	Conditions	T <sub>j</sub> [°C]	Value	Unit
<b>BLOCKING</b>					
V <sub>RRM</sub>	Repetitive peak reverse voltage		120	6000	V
V <sub>RSM</sub>	Non-repetitive peak reverse voltage		120	6100	V
V <sub>DRM</sub>	Repetitive peak off-state voltage		120	6000	V
I <sub>RRM</sub>	Repetitive peak reverse current	V=VRRM	120	300	mA
I <sub>DRM</sub>	Repetitive peak off-state current	V=VDRM	120	300	mA
<b>CONDUCTING</b>					
I <sub>T(AV)</sub>	Mean forward current	180° sin, 50 Hz, Th=55°C, double side cooled		2680	A
I <sub>T(AV)</sub>	Mean forward current	180° sin, 50 Hz, Tc=85°C, double side cooled		1929	A
I <sub>TSM</sub>	Surge forward current	Sine wave, 10 ms	120	50	kA
I <sup>2</sup> t	I <sup>2</sup> t	without reverse voltage		12500 x 10 <sup>3</sup>	A <sup>2</sup> s
V <sub>T</sub>	On-state voltage	On-state current = 6280 A	25	2,78	V
V <sub>T(TO)</sub>	Threshold voltage		120	1,30	V
r <sub>T</sub>	On-state slope resistance		120	0,235	mohm
<b>SWITCHING</b>					
di/dt	Critical rate of rise of on-state current, min.	From 75% VDRM ; gate 10V, 5Ω	120	200	A/μs
dv/dt	Critical rate of rise of off-state voltage, min.	Linear ramp up to 70% of VDRM	120	1000	V/μs
t <sub>d</sub>	Gate controlled delay time, typical	VD=100V; gate source 10V, 10Ω, tr=.5 μs	25		μs
t <sub>q</sub>	Circuit commutated turn-off time, typical	dv/dt = 20 V/μs linear up to 75% VDRM		600	μs
Q <sub>rr</sub>	Reverse recovery charge	di/dt = -20 A/μs, I= 2150 A	120		μC
I <sub>rr</sub>	Peak reverse recovery current	VR= 50 V			A
I <sub>H</sub>	Holding current, typical	VD=5V, gate open circuit	25	500	mA
I <sub>L</sub>	Latching current, typical	VD=12V, tp=30μs	25	1000	mA
<b>GATE</b>					
V <sub>GT</sub>	Gate trigger voltage	VD=12V	25	3,50	V
I <sub>GT</sub>	Gate trigger current	VD=12V	25	400	mA
V <sub>GD</sub>	Non-trigger gate voltage, min.	VD=VDRM	120	0,25	V
V <sub>FGM</sub>	Peak gate voltage (forward)			10	V
I <sub>FGM</sub>	Peak gate current			10	A
V <sub>RGM</sub>	Peak gate voltage (reverse)			10	V
P <sub>GM</sub>	Peak gate power dissipation	Pulse width 100 μs		150	W
P <sub>G</sub>	Average gate power dissipation			3	W
<b>MOUNTING</b>					
R <sub>th(j-h)</sub>	Thermal impedance, DC	Junction to heatsink, double side cooled		8,5	°C/kW
R <sub>th(c-h)</sub>	Thermal impedance	Case to heatsink, double side cooled		1,0	°C/kW
T <sub>j</sub>	Operating junction temperature			-30 / 120	°C
F	Mounting force			80.0 / 100.0	kN
	Mass			3000	g

### ORDERING INFORMATION : AT980 S 60

standard specification   VRRM/100

DISSIPATION CHARACTERISTICS

SQUARE WAVE

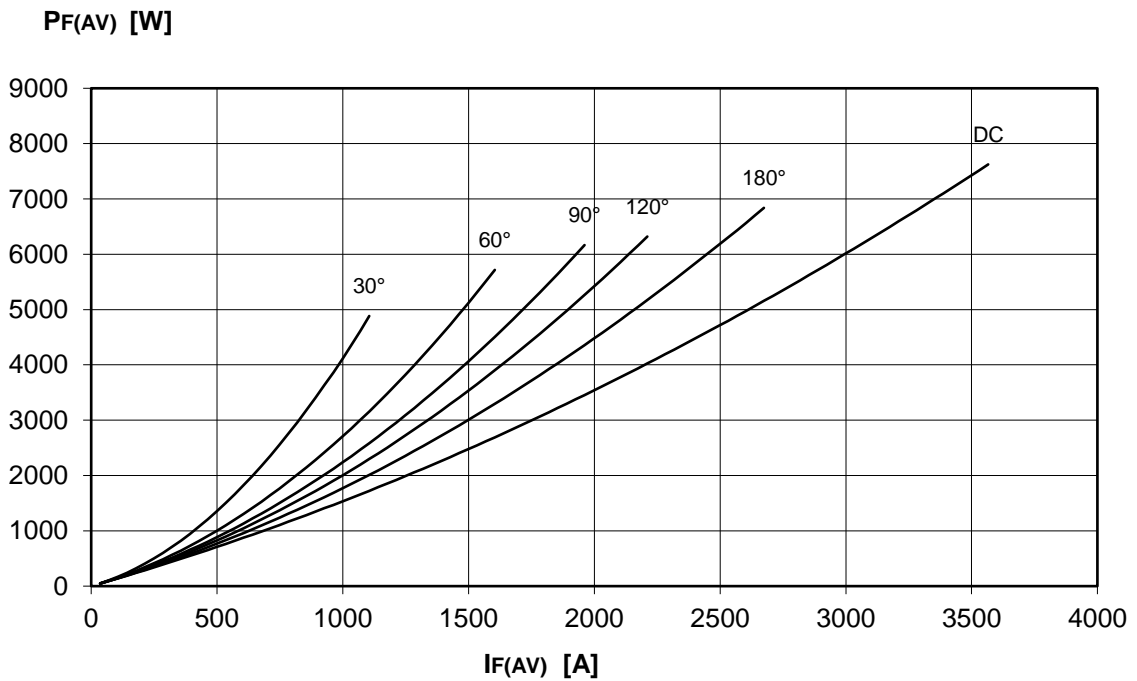
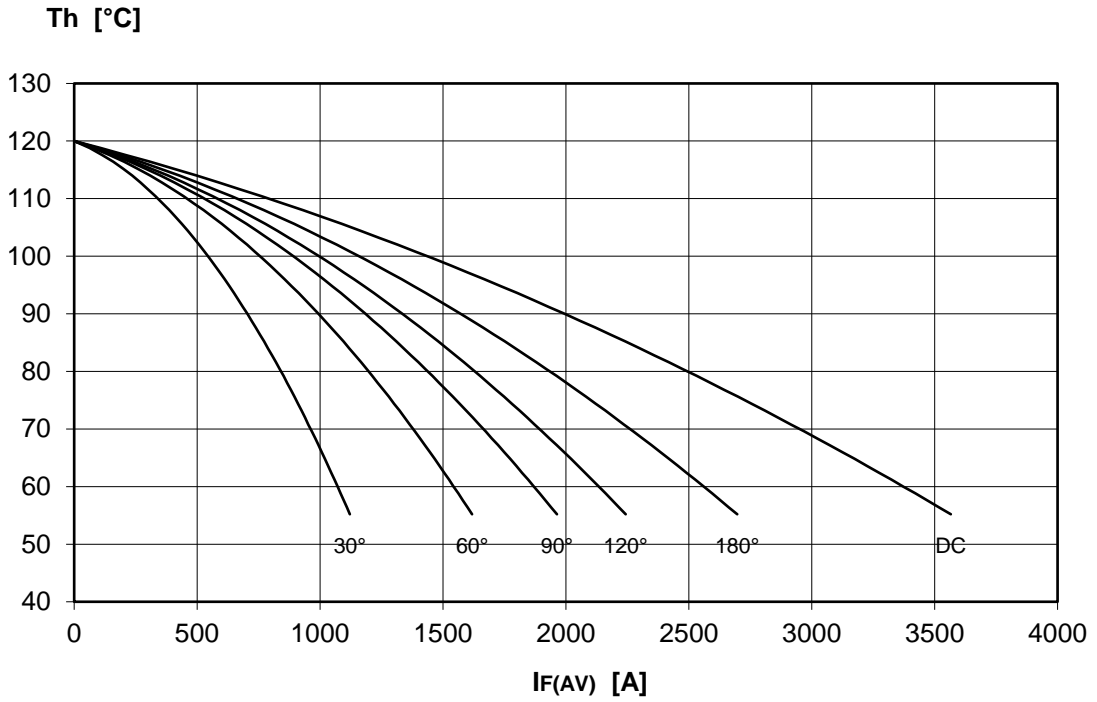

**DISSIPATION CHARACTERISTICS**

SINE WAVE

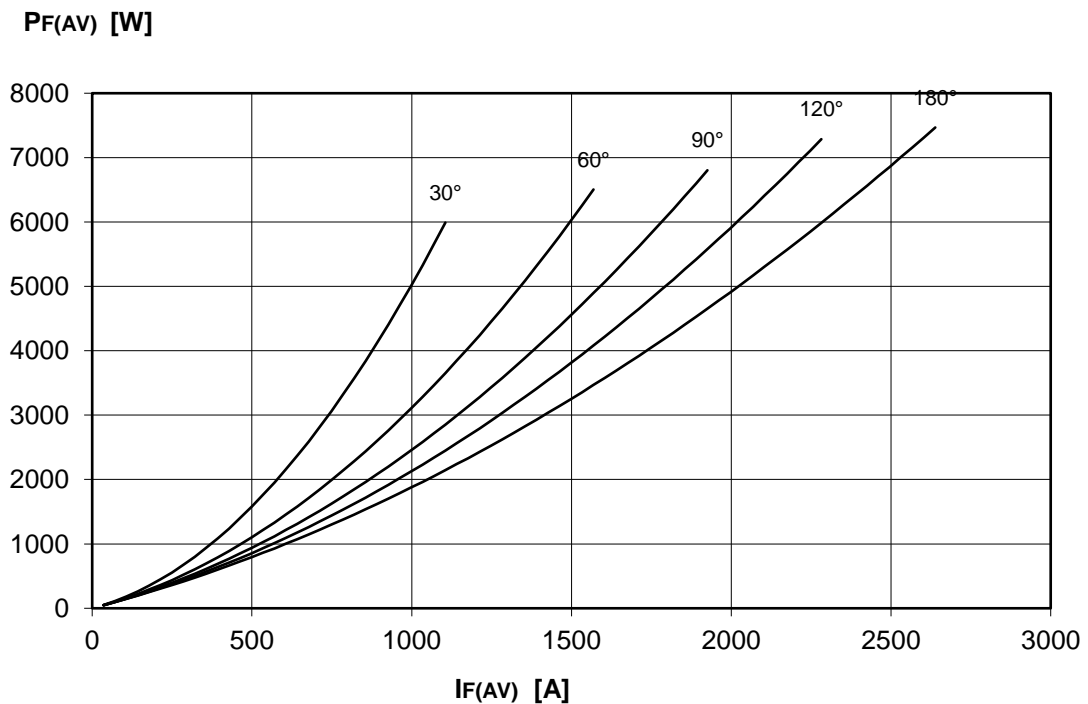
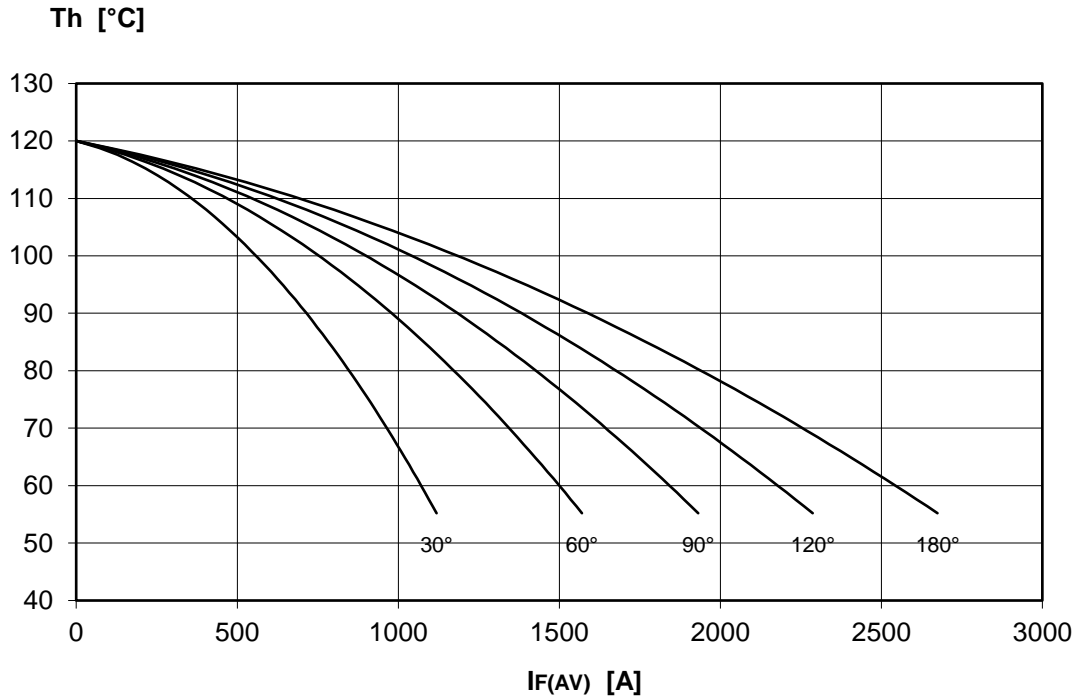

# AT980 PHASE CONTROL THYRISTOR



FINAL SPECIFICATION Feb. 17 - Issue: 6

ON-STATE CHARACTERISTIC  
T<sub>j</sub> = 120 °C

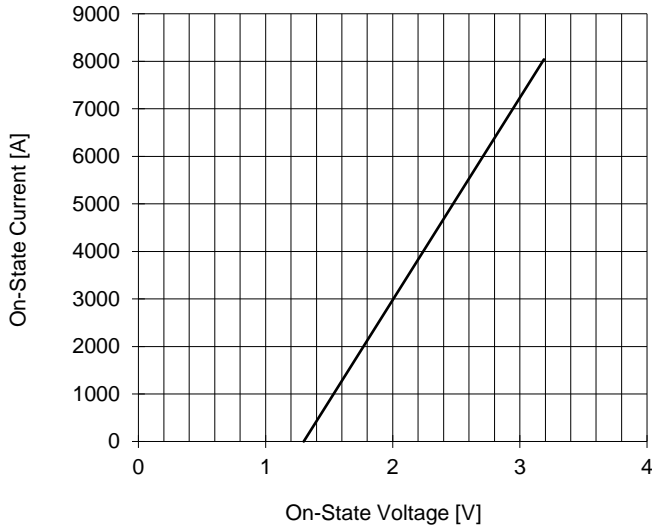

SURGE CHARACTERISTIC  
T<sub>j</sub> = 120 °C

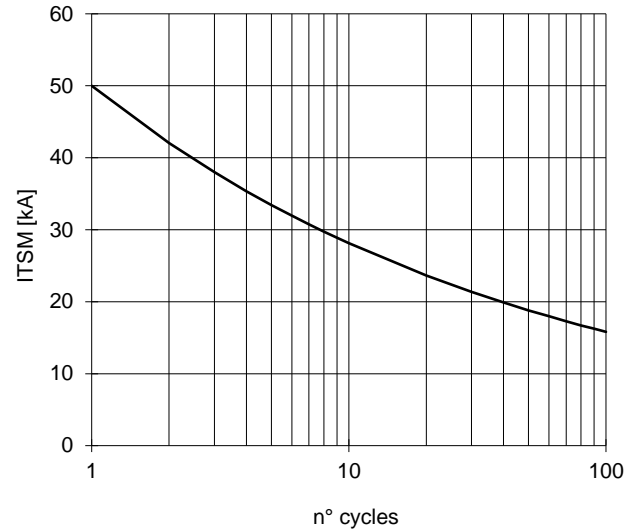

TRANSIENT THERMAL IMPEDANCE  
DOUBLE SIDE COOLED

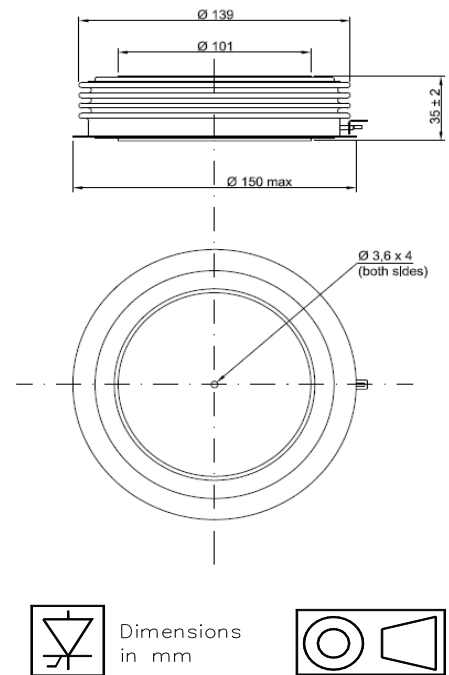
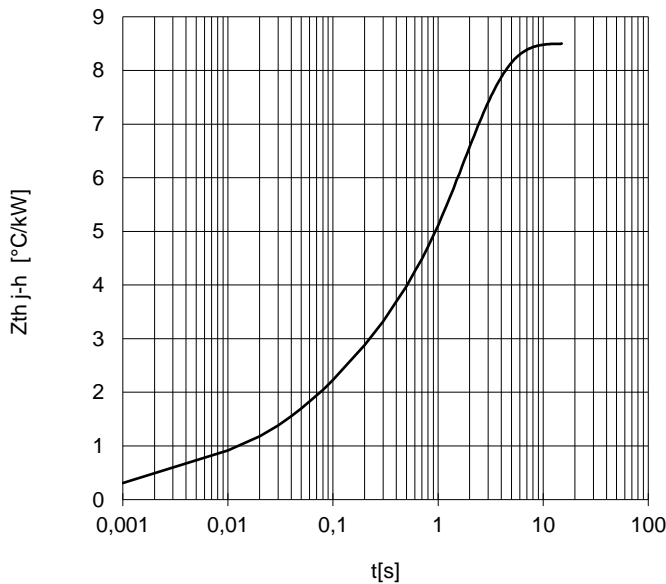

Cathode terminal type DIN 46244 - A 4.8 - 0.8

Gate terminal type AMP 60598 - 1

Distributed by

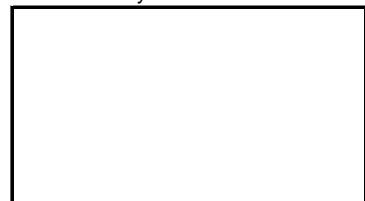

All the characteristics given in this data sheet are guaranteed only with uniform clamping force, cleaned and lubricated heatsink, surfaces with flatness < .03 mm and roughness < 2 µm. In the interest of product improvement POSEICO SpA reserves the right to change any data given in this data sheet at any time without previous notice. If not stated otherwise the maximum value of ratings (symbols over shaded background) and characteristics is reported.