

IGBT Module

Features

- Low VCE (sat) trench IGBT
- Low switching losses
- 10us short circuit capability
- Fast & soft reverse recovery FRD
- Maximum junction temperature 175°C
- Temperature sense included
- Industry standard package with soldering pins for PCB mounting



Typical Applications

- Inverter for motor drive
- AC and DC servo drive amplifier
- Uninterruptible power supply

IGBT-inverter $T_c=25^\circ\text{C}$ unless otherwise noted

Maximum Rated Values

Symbol	Description	HYG15P120H1K1	Units
V_{CES}	Collector-Emitter Voltage $T_j=25^\circ\text{C}$	1200	V
V_{GES}	Gate-Emitter Voltage $T_j=25^\circ\text{C}$	± 20	V
I_c	Collector Current	20	A
	Collector Current $T_C=80^\circ\text{C}$	15	
I_{CM}	Pulsed Collector Current $tp=1\text{ms}$	30	A
P_{tot}	Total Power Dissipation $T_j=175^\circ\text{C}$	156	W

Characteristics Values

Symbol	Parameter	Min.	Typ.	Max.	Units
$V_{(BR)CES}$	Collector-Emitter Breakdown Voltage $T_j=25^\circ\text{C}$	1200			V
I_{CES}	Collector Cut- Off Current $V_{CE}=V_{CES}, V_{GE}=0\text{V}, T_j=25^\circ\text{C}$			0.1	mA
I_{GES}	Gate-Emitter Leakage Current $V_{GE}=V_{GES}, V_{CE}=0\text{V}, T_j=25^\circ\text{C}$	-400		400	nA
$V_{GE(th)}$	Gate to Emitter Threshold Voltage $I_C=1.2\text{mA}, V_{GE}=V_{CE}, T_j=25^\circ\text{C}$	4.6	5.2	6.0	V
$V_{CE(sat)}$	Collector to Emitter Saturation Voltage $I_C=15\text{A}, V_{GE}=15\text{V}, T_j=25^\circ\text{C}$ $I_C=15\text{A}, V_{GE}=15\text{V}, T_j=125^\circ\text{C}$		2.1	2.5	V
			2.4		
R_{Gint}	Integrated Gate Resistor		0		Ω
Q_g	Gate Charge $V_{CE}=600\text{V}, I_C=15\text{A}, V_{GE}=15\text{V}$		0.1		μC
C_{ies}	Input Capacitance		1.38		nF
C_{res}	Reverse Transfer Capacitance $V_{CE}=25\text{V}, V_{GE}=0\text{V}, f=1\text{MHz}$		0.03		nF
$t_{d(on)}$	Turn - on Delay Time $V_{CC}=600\text{V}, I_C=15\text{A}, R_G=30\Omega,$	$T_{vj}=25^\circ\text{C}$		35	ns
		$T_{vj}=125^\circ\text{C}$		40	ns
t_r	Rise Time $V_{GE}=\pm 15\text{V},$ Inductive Load	$T_{vj}=25^\circ\text{C}$		40	ns
		$T_{vj}=125^\circ\text{C}$		45	ns
$t_{d(off)}$	Turn - off Delay Time $V_{CC}=600\text{V}, I_C=15\text{A}, R_G=30\Omega,$	$T_{vj}=25^\circ\text{C}$		240	ns
		$T_{vj}=125^\circ\text{C}$		270	ns
t_f	Fall Time $V_{GE}=\pm 15\text{V},$ Inductive Load	$T_{vj}=25^\circ\text{C}$		100	ns
		$T_{vj}=125^\circ\text{C}$		130	ns
E_{on}	Turn - on Energy $V_{CC}=600\text{V}, I_C=15\text{A}, R_G=30\Omega,$	$T_{vj}=25^\circ\text{C}$		0.7	mJ
		$T_{vj}=125^\circ\text{C}$		1.0	mJ
E_{off}	Turn - off Energy $V_{GE}=\pm 15\text{V},$ Inductive Load	$T_{vj}=25^\circ\text{C}$		1.0	mJ
		$T_{vj}=125^\circ\text{C}$		1.2	mJ
I_{sc}	Short Circuit Current $t_{ps} \leq 10\mu\text{S}, V_{GE}=15\text{V}$ $T_{vj}=125^\circ\text{C}, V_{CC}=600\text{V}$		75		A
R_{thJC}	Junction-to-Case Thermal Resistance (Per IGBT)			0.8	K/W

DIODE-inverter $T_c=25^\circ\text{C}$ unless otherwise noted

Maximum Rated Values

Symbol	Description	HYG15P120H1K1	Units
V_{RRM}	Repetitive Peak Reverse Voltage $T_j=25^\circ\text{C}$	1200	V
I_F	DC Forward Current $T_c=80^\circ\text{C}$	15	A
I_{FRM}	Repetitive Peak Forward Current	30	A

Characteristics Values

Symbol	Parameter		Min.	Typ.	Max.	Units
V_F	Forward Voltage	IF=15A , VGE=0V, T _{vj} =25°C IF=15A , VGE=0V, T _{vj} =125°C		2.2 2.4	2.6	V
t_{rr}	Reverse Recovery Time	IF=15A , VR=600V diF/dt=-400A/μs T _{vj} =125°C		150		ns
I_{RRM}	Max. Reverse Recovery Current			23		A
E_{rec}	Reverse Recovery Charge			0.8		mJ
R_{thJC}	Junction-to-Case Thermal Resistance (Per DIODE)				1.8	K/W

DIODE-rectifier T_c=25°C unless otherwise noted

Maximum Rated Values

Symbol	Description	HYG15P120H1K1	Units
V_{RRM}	Repetitive Peak Reverse Voltage T _j =25°C	1600	V
$I_{F(AV)}$	Average On-state Current per Diode T _c =80°C	20	A
I_{RMSM}	Maximum RMS Current at rectifier Output	tdb	A
I^2t	VR=0V, tp=10ms, T _j =45°C	360	A ² t
I_{FSM}	Surge Forward Current VR=0V, tp=10ms, T _j =45°C	270	A

Characteristics Values

Symbol	Parameter	Test Conditions		Min.	Typ.	Max.	Units
V_F	Diode Forward Voltage	IF=15A	T _j =25°C			1.29	V
			T _j =125°C			1.31	
I_R	Reverse Current	VR=1600V	T _j =25°C			10	μA
			T _j =125°C			1	mA
R_{thJC}	Junction-to-Case Thermal Resistance (Per DIODE)					1.9	K/W

IGBT-brake-chopper T_c=25°C unless otherwise noted

Maximum Rated Values

Symbol	Description	HYG15P120H1K1	Units
V_{CES}	Collector-Emitter Voltage T _j =25°C	1200	V
V_{GES}	Gate-Emitter Voltage T _j =25°C	±20	V
I_c	Collector Current	20	A
	Collector Current TC=80°C	15	
I_{CM}	Pulsed Collector Current tp=1ms	30	A
P_{tot}	Total Power Dissipation T _j =175°C	156	W

Characteristics Values

Symbol	Parameter		Min.	Typ.	Max.	Units
$V_{(BR)CES}$	Collector-Emitter Breakdown Voltage	$T_j=25^\circ\text{C}$	1200			V
I_{CES}	Collector Cut- Off Current	$V_{CE}=V_{CES}, V_{GE}=0\text{V}, T_j=25^\circ\text{C}$			5	mA
I_{GES}	Gate-Emitter Leakage Current	$V_{GE}=V_{GES}, V_{CE}=0\text{V}, T_j=25^\circ\text{C}$	-500		500	nA
$V_{GE(th)}$	Gate to Emitter Threshold Voltage	$I_C=1.2\text{mA}, V_{GE}=V_{CE}, T_j=25^\circ\text{C}$	5	5.8	7.5	V
$V_{CE(sat)}$	Collector to Emitter Saturation Voltage	$I_C=15\text{A}, V_{GE}=15\text{V}, T_j=25^\circ\text{C}$		1.9	2.3	V
		$I_C=15\text{A}, V_{GE}=15\text{V}, T_j=125^\circ\text{C}$		2.3		
R_{Gint}	Integrated Gate Resistor			0		Ω
Q_g	Gate Charge	$V_{CE}=600\text{V}, I_C=15\text{A}, V_{GE}=15\text{V}$		0.09		μC
C_{ies}	Input Capacitance	$V_{CE}=30\text{V}, V_{GE}=0\text{V}, f=0.1\text{MHz}$		1.39		nF
C_{res}	Reverse Transfer Capacitance			0.06		nF
$t_{d(on)}$	Turn - on Delay Time	$V_{CC}=600\text{V}, I_C=15\text{A}, R_G=56\Omega,$	$T_{vj}=25^\circ\text{C}$		60	ns
			$T_{vj}=125^\circ\text{C}$		70	ns
t_r	Rise Time	$V_{GE}=\pm 15\text{V},$ Inductive Load	$T_{vj}=25^\circ\text{C}$		30	ns
			$T_{vj}=125^\circ\text{C}$		40	ns
$t_{d(off)}$	Turn - off Delay Time	$V_{CC}=600\text{V}, I_C=15\text{A}, R_G=56\Omega,$	$T_{vj}=25^\circ\text{C}$		220	ns
			$T_{vj}=125^\circ\text{C}$		250	ns
t_f	Fall Time	$V_{GE}=\pm 15\text{V},$ Inductive Load	$T_{vj}=25^\circ\text{C}$		80	ns
			$T_{vj}=125^\circ\text{C}$		100	ns
E_{on}	Turn - on Energy	$V_{CC}=600\text{V}, I_C=15\text{A}, R_G=56\Omega,$	$T_{vj}=25^\circ\text{C}$		1.2	mJ
			$T_{vj}=125^\circ\text{C}$		1.55	mJ
E_{off}	Turn - off Energy	$V_{GE}=\pm 15\text{V},$ Inductive Load	$T_{vj}=25^\circ\text{C}$		1.4	mJ
			$T_{vj}=125^\circ\text{C}$		1.7	mJ
I_{sc}	Short Circuit Current	$t_{ps}\leq 10\mu\text{S}, V_{GE}=15\text{V}$ $T_{vj}=125^\circ\text{C}, V_{CC}=900\text{V}$		60		A
R_{thJC}	Junction-to-Case Thermal Resistance (Per IGBT)				1.8	K/W

DIODE-brake-chopper $T_c=25^\circ\text{C}$ unless otherwise noted

Maximum Rated Values

Symbol	Description	HYG15P120H1K1	Units
V_{RRM}	Repetitive Peak Reverse Voltage $T_j=25^\circ\text{C}$	1200	V
I_F	DC Forward Current $T_c=80^\circ\text{C}$	10	A
I_{FRM}	Repetitive Peak Forward Current	15	A

Characteristics Values

Symbol	Parameter		Min.	Typ.	Max.	Units
V_F	Forward Voltage	IF=5A , VGE=0V, T_{Vj} =25°C IF=5A , VGE=0V, T_{Vj} =125°C		2.0 1.95	2.2	V
t_{rr}	Reverse Recovery Time	IF=5A , VR=600V		350		ns
I_{RRM}	Max. Reverse Recovery Current	$diF/dt=-200A/\mu s$		6		A
E_{rec}	Reverse Recovery Charge	T_{Vj} =125°C		0.15		mJ
R_{thJC}	Junction-to-Case Thermal Resistance (Per DIODE)				2.5	K/W

Electrical Characteristics of NTC $T_c=25^\circ C$ unless otherwise noted

Symbol	Parameter	Test Conditions	Min.	Typ.	Max.	Units
R25	Rated Resistance	$T_c=25^\circ C$		5.0		kΩ
$\Delta R/R$	Deviation of R100	$T_c=100^\circ C$, R100=493Ω	-5		5	
P25	Power Dissipation	$T_c=25^\circ C$			20	mW
B25/50	B value			3375		K

Module Characteristics

Symbol	Parameter	Min.	Typ.	Max.	Units
V_{iso}	Isolation Voltage RMS, f=50Hz, t=1min		2500		V
T_{Vjmax}	Maximum Junction Temperature			150	°C
T_{Vjop}	Operating Temperature	-40		125	°C
Md	Mounting Screw:M4	3		6	N·m
T_{STG}	Storage Temperature range	-40		125	°C
Weight				190	g

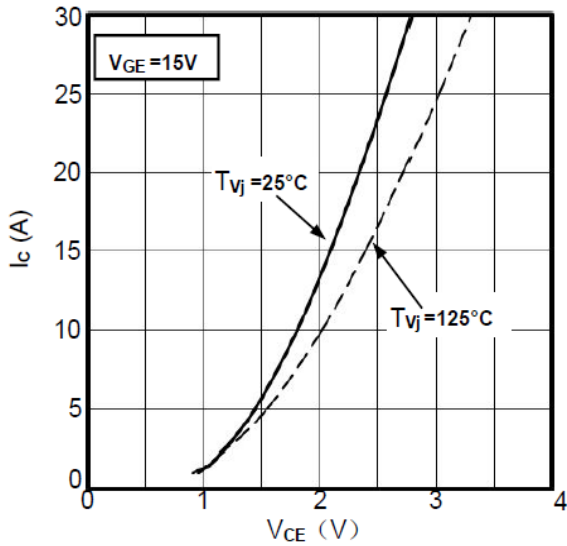

Figure1. Typical Output Characteristics

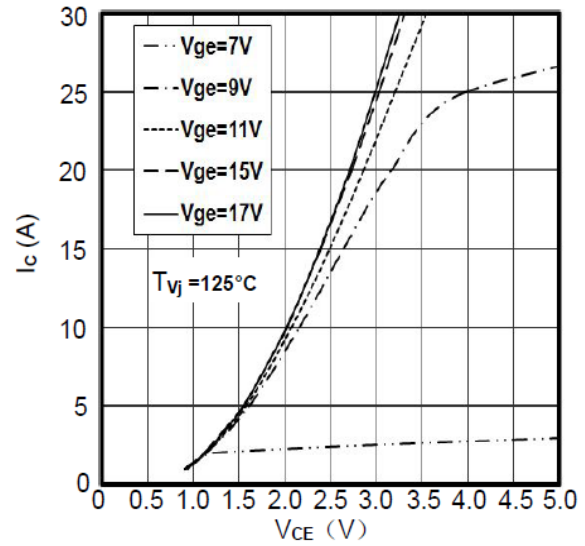

Figure2. Typical Output Characteristics

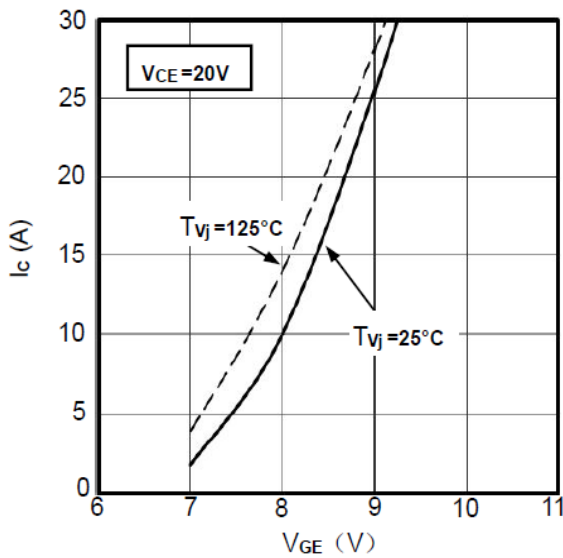

Figure3. Typical Transfer characteristics

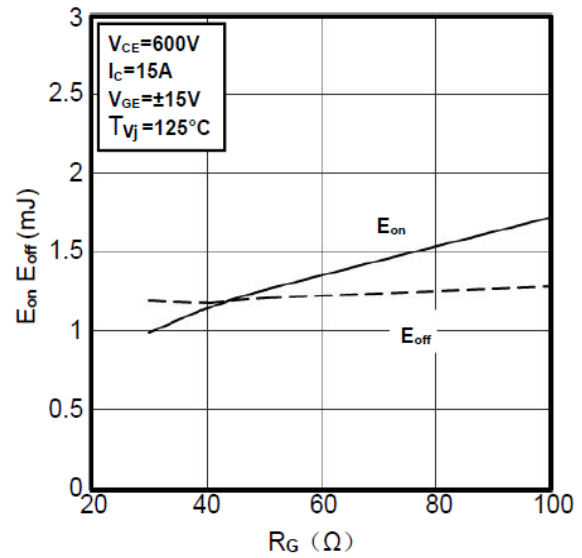

Figure4. Switching Energy vs. Gate Resistor

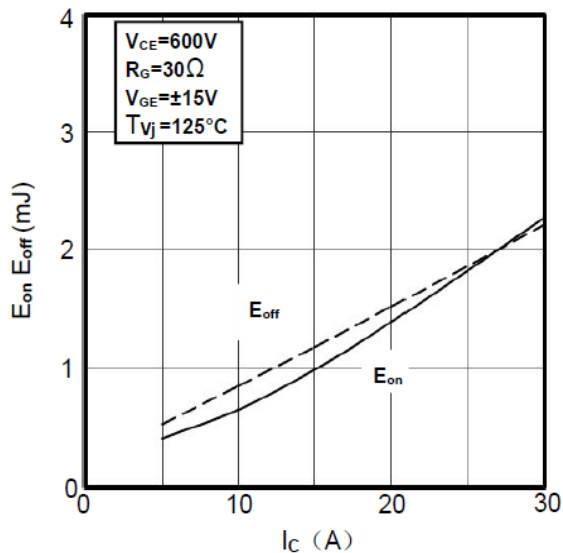

Figure5. Switching Energy vs. Collector Current

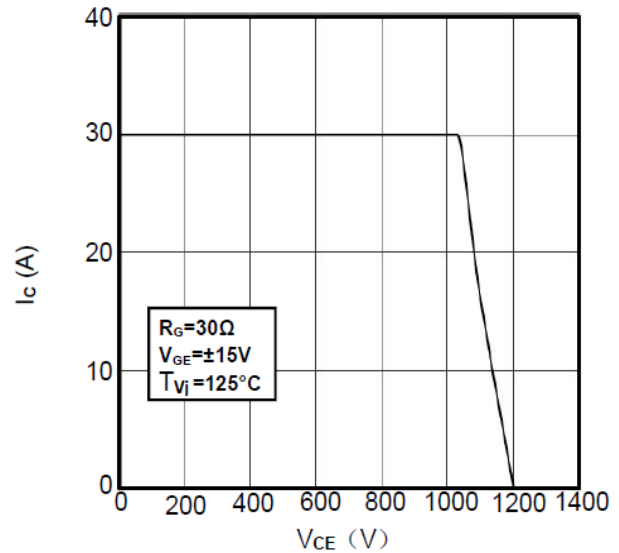

Figure6. Reverse Biased Safe Operating Area

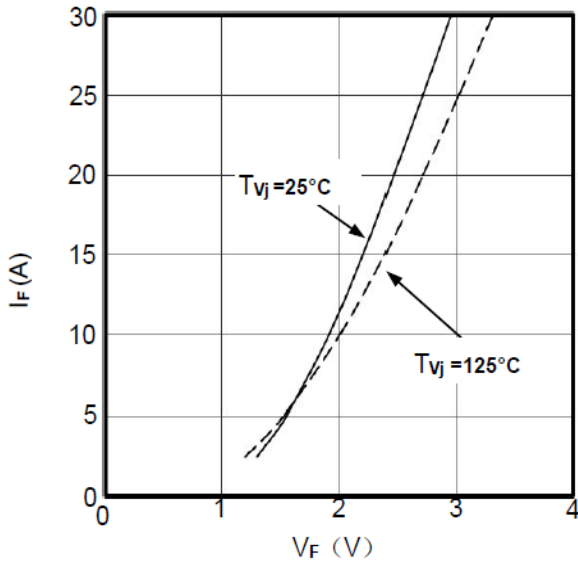

Figure7. Diode Forward Characteristics

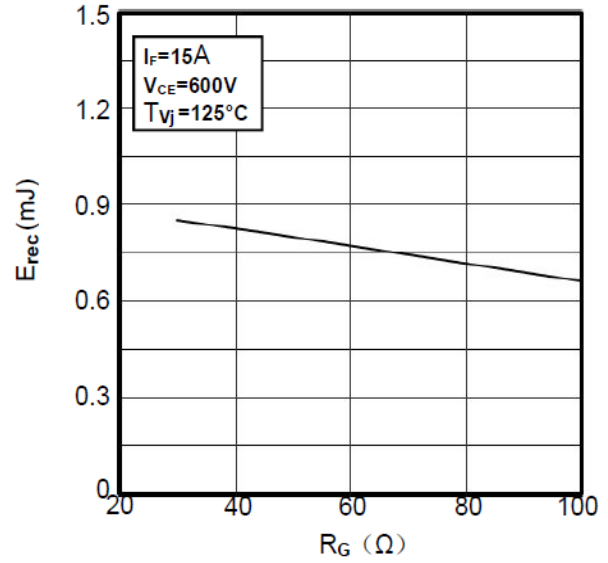

Figure8. Switching Energy vs. Gate Resistor

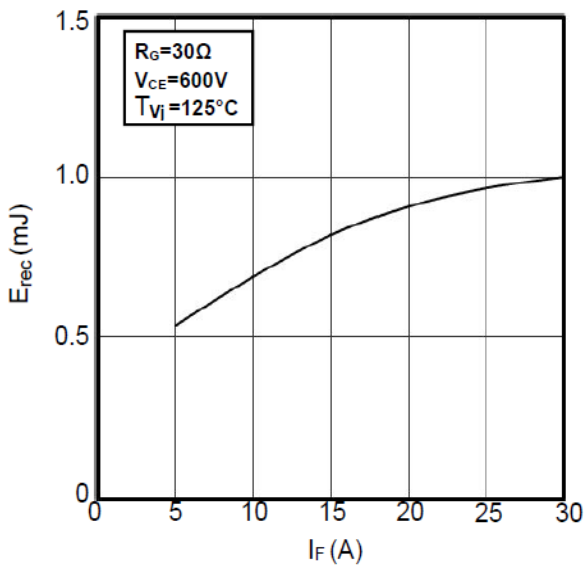

Figure9. Switching Energy vs. Forward Current

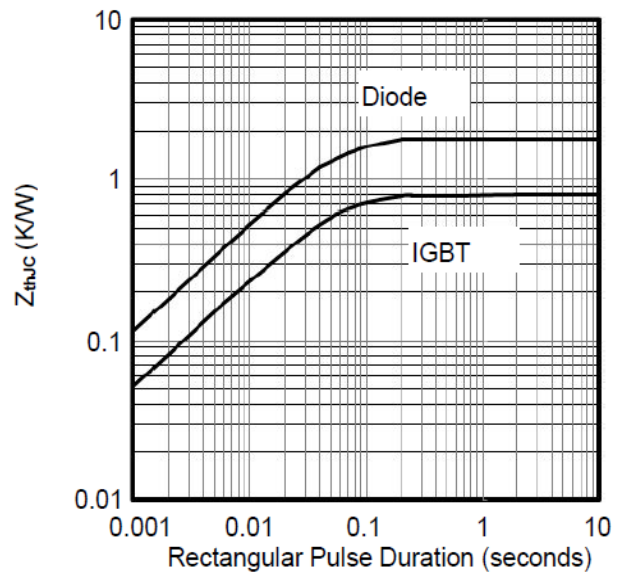

Figure10. Transient Thermal Impedance

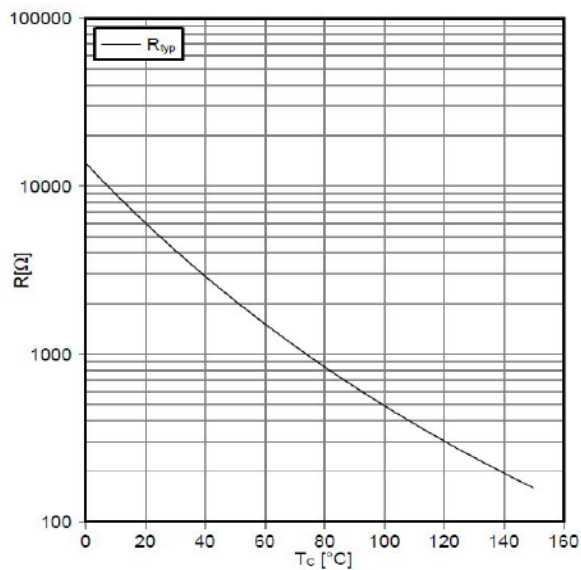

Figure11. NTC-Thermistor-temperature characteristic

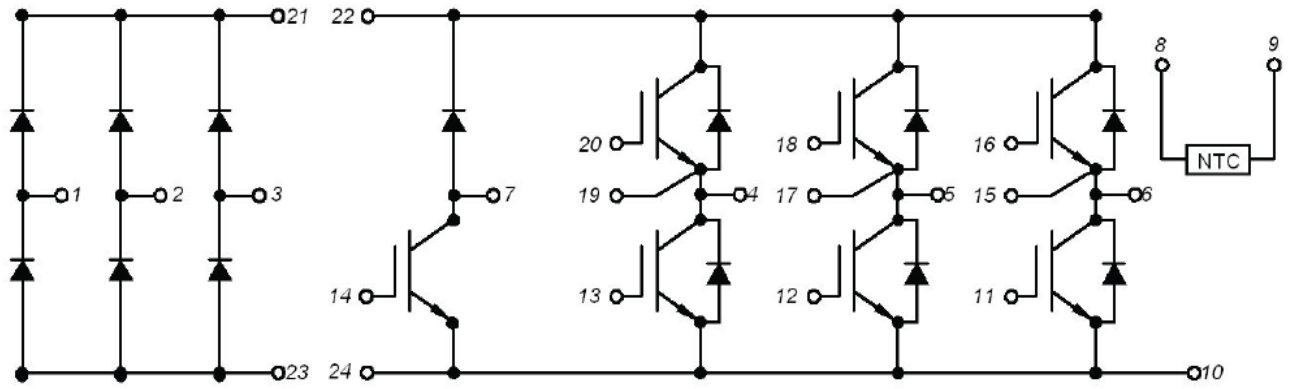

Figure11. Circuit Diagram

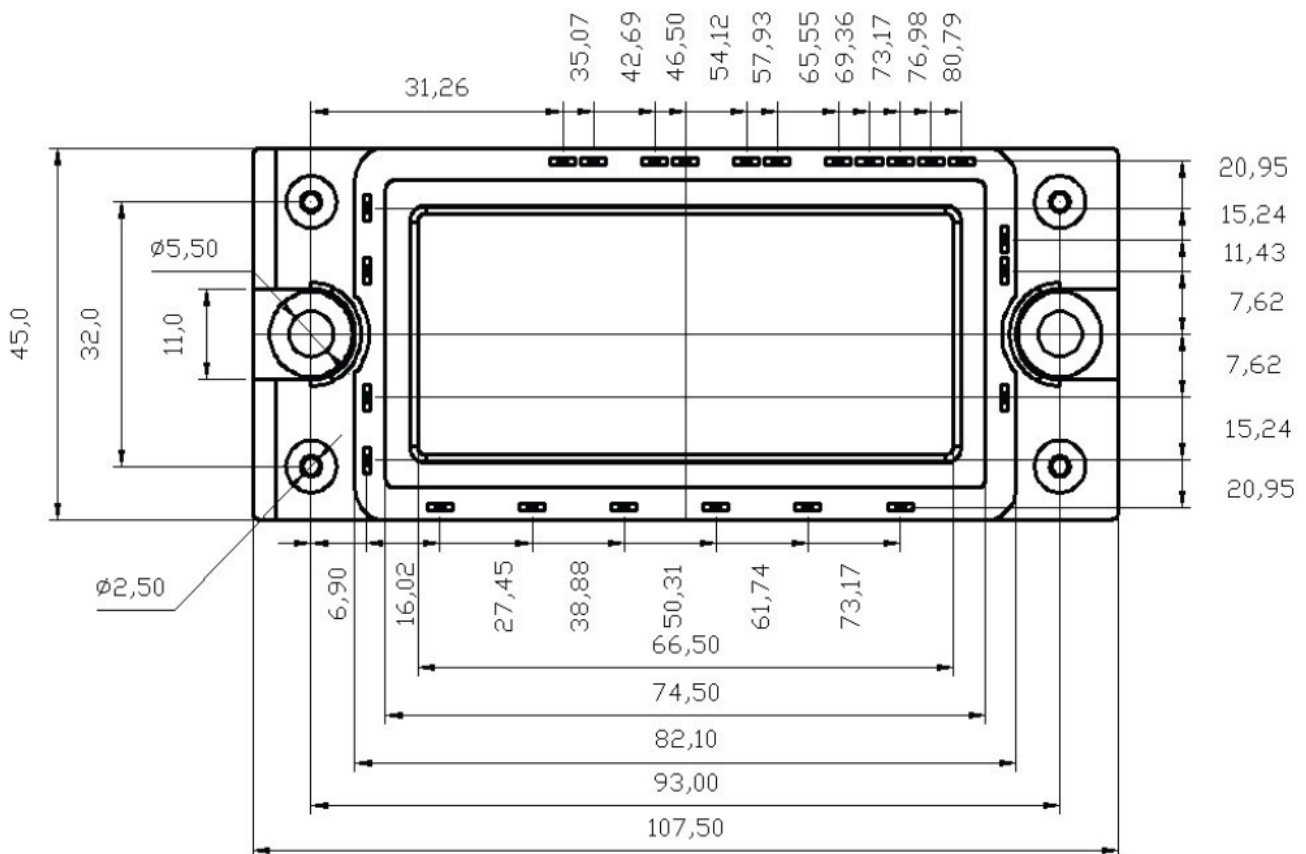
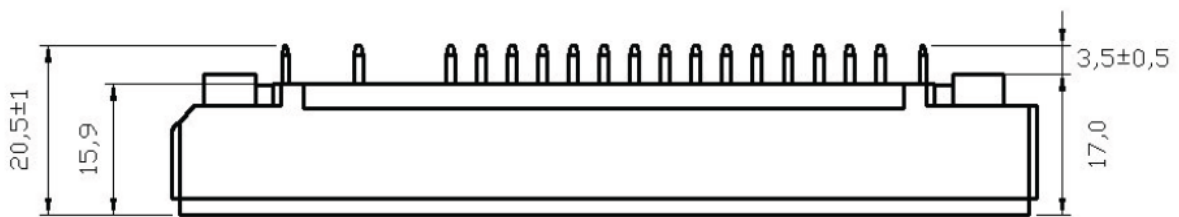

Figure12. Package Dimensions (mm)