

Dual Ultrathin 2A or Single 4A Step-Down DC/DC μ Module Regulator

FEATURES

- Complete Solution in $<1\text{cm}^2$
- Wide Input Voltage Range: 3.6V to 20V
- 1.5V to 12V Output Voltage
- Dual 2A (3A Peak) or Single 4A Output Current
- $\pm 1.5\%$ Maximum Total Output Voltage Regulation Error Over Load, Line and Temperature
- Current Mode Control, Fast Transient Response
- External Frequency Synchronization
- Multiphase Parallelable with Current Sharing
- Output Voltage Tracking and Soft-Start Capability
- Selectable Burst Mode® Operation
- Overvoltage Input and Overtemperature Protection
- Power Good Indicators
- 6.25mm \times 6.25mm \times 1.82mm LGA and 6.25mm \times 6.25mm \times 2.42mm BGA Packages

APPLICATIONS

- General Purpose Point-of-Load Conversion
- Telecom, Networking and Industrial Equipment
- Medical Diagnostic Equipment
- Test and Debug Systems

All registered trademarks and trademarks are the property of their respective owners.

DESCRIPTION

The LTM®4622A is a complete dual 2A step-down switching mode μ Module® (micromodule) regulator in a tiny ultrathin 6.25mm \times 6.25mm \times 1.82mm LGA and 2.42mm BGA packages. Included in the package are the switching controller, power FETs, inductor and support components. Operating over an input voltage range of 3.6V to 20V, the LTM4622A supports an output voltage range of 1.5V to 12V, set by a single external resistor. Its high efficiency design delivers dual 2A continuous, 3A peak, output current. Only a few ceramic input and output capacitors are needed.

The LTM4622A supports selectable Burst Mode operation and output voltage tracking for supply rail sequencing. Its high switching frequency and current mode control enable a very fast transient response to line and load changes without sacrificing stability.

Fault protection features include input overvoltage, output overcurrent and overtemperature protection.

The LTM4622A is available with SnPb (BGA) or RoHS compliant terminal finish.

Product Selection Guide

PART NUMBER	V _{IN} RANGE	V _{OUT} RANGE	I _{OUT}
LTM4622	3.6V to 20V	0.6V to 5.5V	Dual 2.5A or Single 5A
LTM4622A		1.5V to 12V	Dual 2A or Single 4A

TYPICAL APPLICATION

3.3V and 5V Dual Output DC/DC Step-Down μ Module Regulator

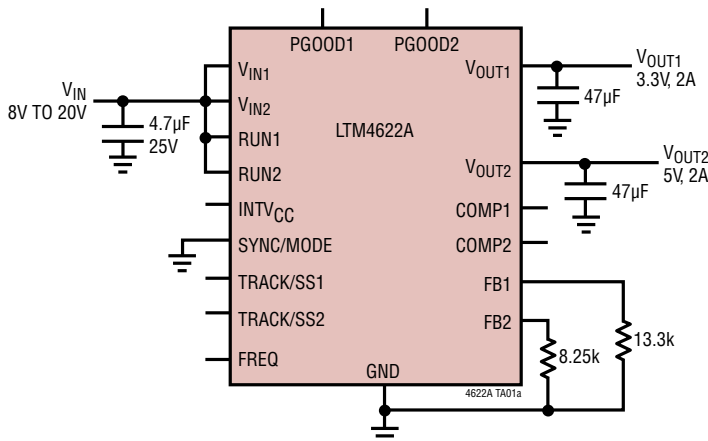

12V Input, 3.3V and 5V Output, Efficiency vs Load Current

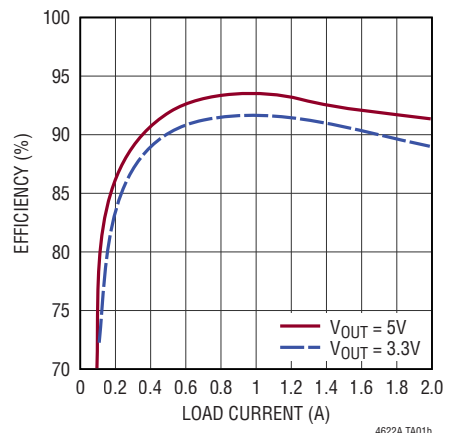

LTM4622A

ABSOLUTE MAXIMUM RATINGS (Note 1)

V_{IN1} , V_{IN2}	-0.3V to 22V	Operating Internal Temperature Range	
V_{OUT}	-0.3V to 16V	(Note 2)	-40°C to 125°C
PGOOD1, PGOOD2	-0.3V to 18V	Storage Temperature Range	-55°C to 125°C
RUN1, RUN2	-0.3V to $V_{IN} + 0.3V$	Peak Solder Reflow Body Temperature	260°C
INTV _{CC} , TRACK/SS1, TRACK/SS2	-0.3V to 3.6V		
SYNC/MODE, COMP1, COMP2, FB1, FB2	-0.3V to INTV _{CC}		

PIN CONFIGURATION (See Pin Functions, Pin Configuration Table)

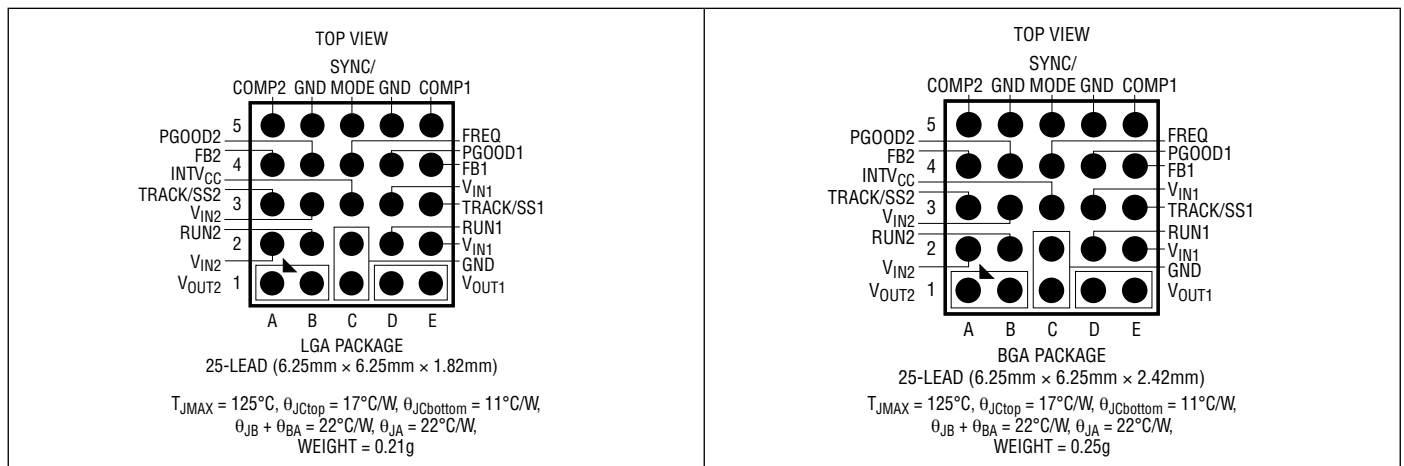

ORDER INFORMATION <http://www.linear.com/product/LTM4622A#orderinfo>

PART NUMBER	PAD OR BALL FINISH	PART MARKING*		PACKAGE TYPE	MSL RATING	TEMPERATURE RANGE (Note 2)
		DEVICE	FINISH CODE			
LTM4622AEV#PBF	Au (RoHS)	LTM4622AV	e4	LGA	4	-40°C to 125°C
LTM4622AIV#PBF	Au (RoHS)	LTM4622AV	e4	LGA	4	-40°C to 125°C
LTM4622AEY#PBF	SAC305 (RoHS)	LTM4622AY	e1	BGA	4	-40°C to 125°C
LTM4622AIY#PBF	SAC305 (RoHS)	LTM4622AY	e1	BGA	4	-40°C to 125°C
LTM4622AIY	SnPb (63/37)	LTM4622AY	e0	BGA	4	-40°C to 125°C

Consult Marketing for parts specified with wider operating temperature ranges. *Device temperature grade is indicated by a label on the shipping container. Pad or ball finish code is per IPC/JEDEC J-STD-609.

- Pb-free and Non-Pb-free Part Markings:
www.linear.com/leadfree

- Recommended LGA and BGA PCB Assembly and Manufacturing Procedures:
www.linear.com/umodule/pcbassembly
- LGA and BGA Package and Tray Drawings:
www.linear.com/packaging

ELECTRICAL CHARACTERISTICS

The ● denotes the specifications which apply over the specified internal operating temperature range (Note 2). Specified as each individual output channel at $T_A = 25^\circ\text{C}$, $V_{IN1} = V_{IN2} = 12\text{V}$, unless otherwise noted per the typical application shown in Figure 27.

SYMBOL	PARAMETER	CONDITIONS	MIN	TYP	MAX	UNITS	
Switching Regulator Section: per Channel							
V_{IN1}	Input DC Voltage Range		●	3.6	20	V	
V_{IN2}	Input DC Voltage Range	$3.6\text{V} < V_{IN1} < 20\text{V}$	●	1.5	20	V	
$V_{OUT(\text{RANGE})}$	Output Voltage Range	$V_{IN1} = V_{IN2} = 3.6\text{V to } 20\text{V}$	●	1.5	12	V	
$V_{OUT(\text{DC})}$	Output Voltage, Total Variation with Line and Load	$C_{IN} = 22\mu\text{F}$, $C_{OUT} = 100\mu\text{F}$ Ceramic, $R_{FB} = 40.2\text{k}$, $\text{MODE} = \text{INTV}_{CC}$, $V_{IN1} = V_{IN2} = 3.6\text{V to } 20\text{V}$, $I_{OUT} = 0\text{A to } 2\text{A}$	●	1.477	1.50	1.523	V
V_{RUN}	RUN Pin On Threshold	RUN Threshold Rising RUN Threshold Falling		1.20 0.97	1.27 1.00	1.35 1.03	V V
$I_{Q(VIN)}$	Input Supply Bias Current	$V_{IN1} = V_{IN2} = 12\text{V}$, $V_{OUT} = 1.5\text{V}$, $\text{MODE} = \text{GND}$ $V_{IN1} = V_{IN2} = 12\text{V}$, $V_{OUT} = 1.5\text{V}$, $\text{MODE} = \text{INTV}_{CC}$ Shutdown, $\text{RUN1} = \text{RUN2} = 0$		7 500 45		mA μA μA	
$I_{S(VIN)}$	Input Supply Current	$V_{IN1} = V_{IN2} = 12\text{V}$, $V_{OUT} = 1.5\text{V}$, $I_{OUT} = 2\text{A}$		0.32		A	
$I_{OUT(\text{DC})}$	Output Continuous Current Range	$V_{IN1} = V_{IN2} = 12\text{V}$, $V_{OUT} = 1.5\text{V}$ (Note 3)	●	0	2	A	
$\Delta V_{OUT(\text{Line})}/V_{OUT}$	Line Regulation Accuracy	$V_{OUT} = 1.5\text{V}$, $V_{IN1} = V_{IN2} = 3.6\text{V to } 20\text{V}$, $I_{OUT} = 0\text{A}$	●	0.01	0.1	%/V	
$\Delta V_{OUT(\text{Load})}/V_{OUT}$	Load Regulation Accuracy	$V_{OUT} = 1.5\text{V}$, $I_{OUT} = 0\text{A to } 2\text{A}$	●	0.2	1.0	%	
$V_{OUT(\text{AC})}$	Output Ripple Voltage	$I_{OUT} = 0\text{A}$, $C_{OUT} = 100\mu\text{F}$ Ceramic, $V_{IN1} = V_{IN2} = 12\text{V}$, $V_{OUT} = 1.5\text{V}$		5		mV	
$\Delta V_{OUT(\text{START})}$	Turn-On Overshoot	$I_{OUT} = 0\text{A}$, $C_{OUT} = 100\mu\text{F}$ Ceramic, $V_{IN1} = V_{IN2} = 12\text{V}$, $V_{OUT} = 1.5\text{V}$		30		mV	
t_{START}	Turn-On Time	$C_{OUT} = 100\mu\text{F}$ Ceramic, No Load, $\text{TRACK}/\text{SS} = 0.01\mu\text{F}$, $V_{IN1} = V_{IN2} = 12\text{V}$, $V_{OUT} = 1.5\text{V}$		1.25		ms	
ΔV_{OUTLS}	Peak Deviation for Dynamic Load	Load: 0% to 50% to 0% of Full Load, $C_{OUT} = 100\mu\text{F}$ Ceramic, $V_{IN1} = V_{IN2} = 12\text{V}$, $V_{OUT} = 1.5\text{V}$		100		mV	
t_{SETTLE}	Settling Time for Dynamic Load Step	Load: 0% to 50% to 0% of Full Load, $C_{OUT} = 100\mu\text{F}$ Ceramic, $V_{IN1} = V_{IN2} = 12\text{V}$, $V_{OUT} = 1.5\text{V}$		20		μs	
I_{OUTPK}	Output Current Limit	$V_{IN1} = V_{IN2} = 12\text{V}$, $V_{OUT} = 1.5\text{V}$		3	4	A	
V_{FB}	Voltage at FB Pin	$I_{OUT} = 0\text{A}$, $V_{OUT} = 1.5\text{V}$	●	0.592	0.60	0.608	V
I_{FB}	Current at FB Pin	(Note 4)			± 30	nA	
R_{FBHI}	Resistor Between V_{OUT} and FB Pins			60.00	60.40	60.80	k Ω
$I_{\text{TRACK}/\text{SS}}$	Track Pin Soft-Start Pull-Up Current	$\text{TRACK}/\text{SS} = 0\text{V}$		1.25		μA	
t_{SS}	Internal Soft-Start Time	10% to 90% Rise Time (Note 4)		400	700	μs	
$t_{\text{ON}(\text{MIN})}$	Minimum On-Time	(Note 4)		20		ns	
$t_{\text{OFF}(\text{MIN})}$	Minimum Off-Time	(Note 4)		45		ns	
V_{PGOOD}	PGOOD Trip Level	V_{FB} With Respect to Set Output V_{FB} Ramping Negative V_{FB} Ramping Positive		-8 8	-14 14	% %	
R_{PGOOD}	PGOOD Pull-Down Resistance	1mA Load		20		Ω	
V_{INTVCC}	Internal V_{CC} Voltage	$V_{IN1} = V_{IN2} = 3.6\text{V to } 20\text{V}$		3.1	3.3	3.5	V

ELECTRICAL CHARACTERISTICS

The ● denotes the specifications which apply over the specified internal operating temperature range (Note 2). Specified as each individual output channel at $T_A = 25^\circ\text{C}$, $V_{IN1} = V_{IN2} = 12\text{V}$, unless otherwise noted per the typical application shown in Figure 27.

SYMBOL	PARAMETER	CONDITIONS	MIN	TYP	MAX	UNITS
V_{INTVCC} Load Reg	INTV _{CC} Load Regulation	$I_{CC} = 0\text{mA}$ to 50mA		1.3		%
f_{OSC}	Oscillator Frequency			1		MHz
f_{SYNC}	Frequency Sync Range	With Respect to Set Frequency		± 30		%
I_{MODE}	MODE Input Current	MODE = INTV _{CC}		-1.5		μA

Note 1: Stresses beyond those listed under Absolute Maximum Ratings may cause permanent damage to the device. Exposure to any Absolute Maximum Rating condition for extended periods may affect device reliability and lifetime.

Note 2: The LTM4622A is tested under pulsed load conditions such that $T_J \approx T_A$. The LTM4622AE is guaranteed to meet performance specifications over the 0°C to 125°C internal operating temperature range. Specifications over the full -40°C to 125°C internal operating temperature range are assured by design, characterization and correlation with statistical process controls. The LTM4622AI is guaranteed to meet specifications over the full -40°C to 125°C internal operating temperature range. Note that the maximum ambient temperature consistent with these specifications is determined by specific operating conditions in conjunction with board layout, the rated package thermal resistance and other environmental factors.

Note 3: See output current derating curves for different V_{IN} , V_{OUT} and T_A .

Note 4: 100% tested at wafer level.

Note 5: This IC includes overtemperature protection that is intended to protect the device during momentary overload conditions. Junction temperature will exceed 125°C when overtemperature protection is active. Continuous operation above the specified maximum operating junction temperature may impair device reliability.

TYPICAL PERFORMANCE CHARACTERISTICS

Efficiency vs Load Current at 5V_{IN}

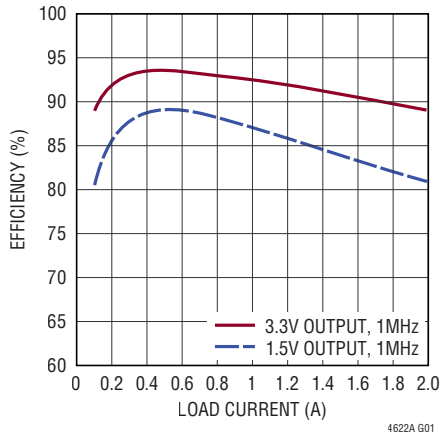

4622A G01

Efficiency vs Load Current at 12V_{IN}

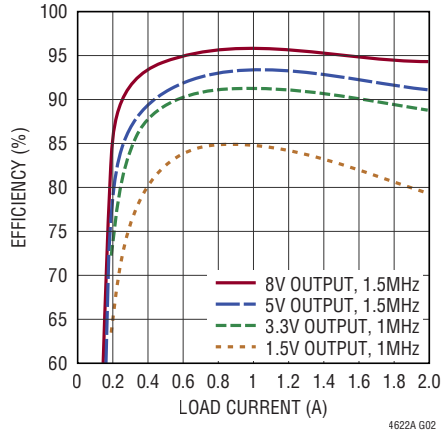

4622A G02

Efficiency vs Load Current at 16V_{IN}

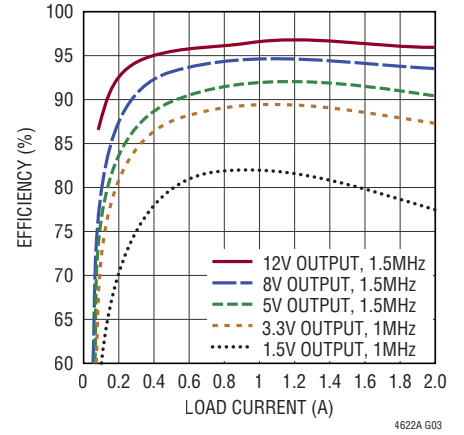

4622A G03

Burst Mode Efficiency, 12V_{IN}, 1.5V_{OUT}

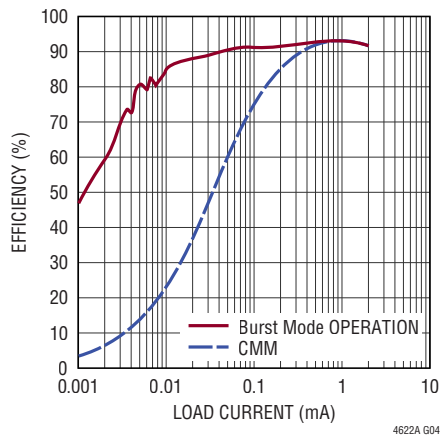

4622A G04

1.5V Output Transient Response

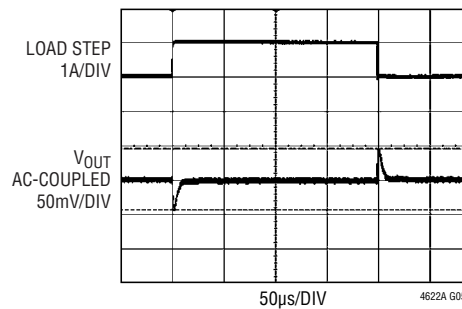

4622A G05

V_{IN} = 12V, V_{OUT} = 1.5V, f_{SW} = 1MHz
 OUTPUT CAPACITOR = 47µF ×1 CERAMIC
 10pF FEED-FORWARD CAPACITOR
 LOAD-STEP = 1A TO 2A (10A/µs)

3.3V Output Transient Response

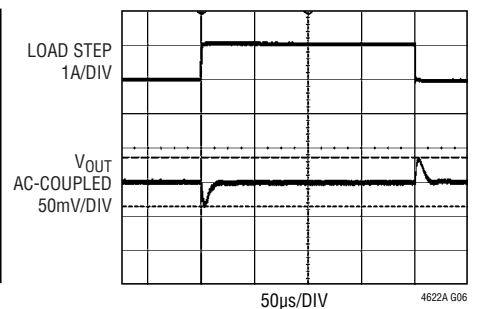

4622A G06

V_{IN} = 12V, V_{OUT} = 3.3V, f_{SW} = 1MHz
 OUTPUT CAPACITOR = 47µF ×1 CERAMIC
 10pF FEED-FORWARD CAPACITOR
 LOAD-STEP = 1A TO 2A (10A/µs)

5V Output Transient Response

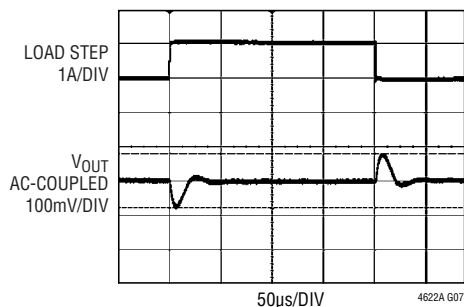

4622A G07

V_{IN} = 12V, V_{OUT} = 5V, f_{SW} = 1MHz
 OUTPUT CAPACITOR = 47µF ×2 CERAMIC
 10pF FEED-FORWARD CAPACITOR
 LOAD-STEP = 1A TO 2A (10A/µs)

8V Output Transient Response

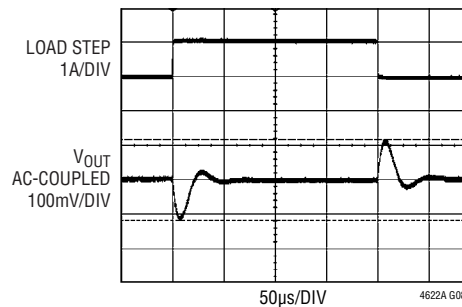

4622A G08

V_{IN} = 12V, V_{OUT} = 8V, f_{SW} = 1.5MHz
 OUTPUT CAPACITOR = 47µF ×2 CERAMIC
 10pF FEED-FORWARD CAPACITOR
 LOAD-STEP = 1A TO 2A (10A/µs)

12V Output Transient Response

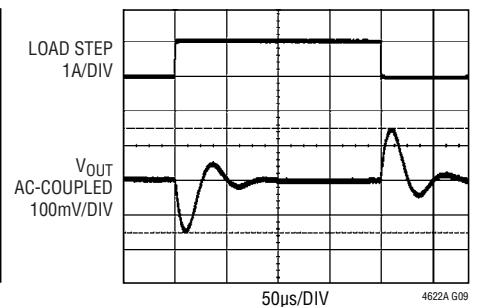

4622A G09

V_{IN} = 16V, V_{OUT} = 12V, f_{SW} = 1.5MHz
 OUTPUT CAPACITOR = 47µF ×2 CERAMIC
 10pF FEED-FORWARD CAPACITOR
 LOAD-STEP = 1A TO 2A (10A/µs)

TYPICAL PERFORMANCE CHARACTERISTICS

Start-Up with No Load Current Applied

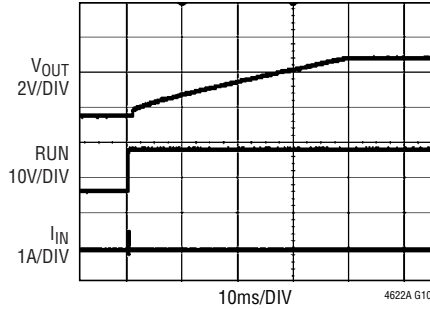

$V_{IN} = 12V$, $V_{OUT} = 3.3V$, $f_{SW} = 1MHz$
 OUTPUT CAPACITOR = $10\mu F$ CERAMIC
 + $47\mu F$ POSCAP
 SOFT-START CAP = $0.1\mu F$

Start-Up with 2A Load Current Applied

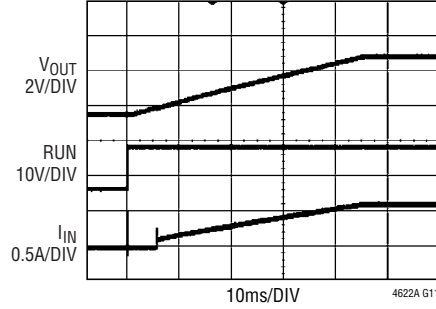

$V_{IN} = 12V$, $V_{OUT} = 3.3V$, $f_{SW} = 1MHz$
 OUTPUT CAPACITOR = $10\mu F$ CERAMIC
 + $47\mu F$ POSCAP
 SOFT-START CAP = $0.1\mu F$

Short-Circuit with No Load Current Applied

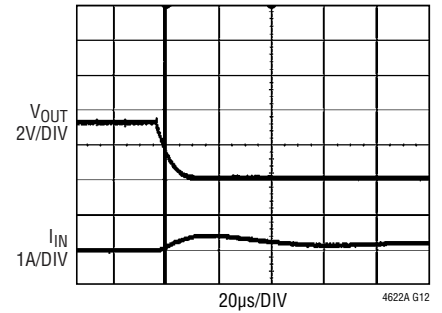

$V_{IN} = 12V$, $V_{OUT} = 3.3V$, $f_{SW} = 1MHz$
 OUTPUT CAPACITOR = $10\mu F$ CERAMIC
 + $47\mu F$ POSCAP

Short-Circuit with 2A Load Current Applied

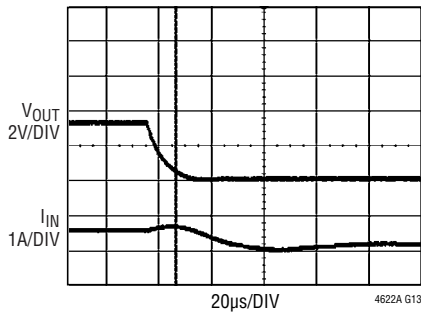

$V_{IN} = 12V$, $V_{OUT} = 3.3V$, $f_{SW} = 1MHz$
 OUTPUT CAPACITOR = $10\mu F$ + $47\mu F$ POSCAP

Recover from Short-Circuit with No Load Current Applied

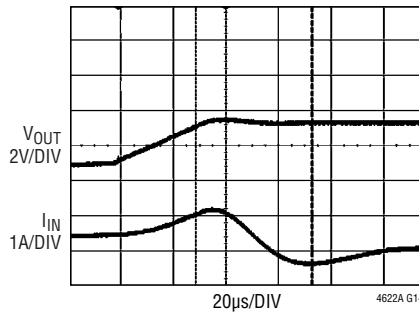

$V_{IN} = 12V$, $V_{OUT} = 3.3V$, $f_{SW} = 1MHz$
 OUTPUT CAPACITOR = $10\mu F$ + $47\mu F$ POSCAP

Steady-State Output Voltage Ripple

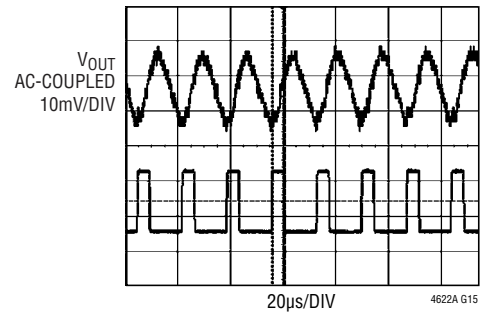

$V_{IN} = 12V$, $V_{OUT} = 3.3V$, $f_{SW} = 1MHz$
 OUTPUT CAPACITOR = $10\mu F$ + $47\mu F$ POSCAP

PIN FUNCTIONS



PACKAGE ROW AND COLUMN LABELING MAY VARY AMONG μ Module PRODUCTS. REVIEW EACH PACKAGE LAYOUT CAREFULLY.

V_{IN1} (D3, E2), V_{IN2} (A2, B3): Power Input Pins. Apply input voltage between these pins and GND pins. Recommend placing input decoupling capacitance directly between BOTH V_{IN1} and V_{IN2} pins and GND pins. Please note the module internal control circuitry is running off V_{IN1} . Channel 2 will not work without a voltage higher than 3.6V presents at V_{IN1} .

GND (C1 to C2, B5, D5): Power Ground Pins for Both Input and Output Returns.

INTV_{CC} (C3): Internal 3.3V Regulator Output. The internal power drivers and control circuits are powered from this voltage. This pin is internally decoupled to GND with a 2.2 μ F low ESR ceramic capacitor. No additional external decoupling capacitor needed.

SYNC/MODE (C5): Mode Select and External Synchronization Input. Tie this pin to ground to force continuous synchronous operation at all output loads. Floating this pin or tying it to INTV_{CC} enables high efficiency Burst Mode operation at light loads. Drive this pin with a clock to synchronize the LTM4622A switching frequency. An internal phase-locked loop will force the bottom power NMOS's turn on signal to be synchronized with the rising edge of the clock signal. When this pin is driven with a clock, forced continuous mode is automatically selected.

V_{OUT1} (D1, E1), V_{OUT2} (A1, B1): Power Output Pins of Each Switching Mode Regulator. Apply output load between these pins and GND pins. Recommend placing output decoupling capacitance directly between these pins and GND pins.

FREQ (C4): Frequency is set internally to 1MHz. An external resistor can be placed from this pin to GND to increase frequency, or from this pin to INTV_{CC} to reduce frequency. See the Applications Information section for frequency adjustment.

RUN1 (D2), RUN2 (B2): Run Control Input of Each Switching Mode Regulator Channel. Enables chip operation by tying RUN above 1.27V. Tying this pin below 1V shuts down the specific regulator channel. Do not float this pin.

PGOOD1 (D4), PGOOD2 (B4): Output Power Good with Open-Drain Logic of Each Switching Mode Regulator Channel. PGOOD is pulled to ground when the voltage on the FB pin is not within $\pm 8\%$ (typical) of the internal 0.6V reference.

TRACK/SS1 (E3), TRACK/SS2 (A3): Output Tracking and Soft-Start Pin of Each Switching Mode Regulator Channel. It allows the user to control the rise time of the output voltage. Putting a voltage below 0.6V on this pin bypasses the internal reference input to the error amplifier, instead it servos the FB pin to the TRACK voltage. Above 0.6V, the tracking function stops and the internal reference resumes control of the error amplifier. There's an internal 1.4 μ A pull-up current from INTV_{CC} on this pin, so putting a capacitor here provides soft-start function. A default internal soft-start ramp forces a minimum soft-start time of 400 μ s.

FB1 (E4), FB2 (A4): The Negative Input of the Error Amplifier for Each Switching Mode Regulator Channel. Internally, this pin is connected to V_{OUT} with a 60.4k precision resistor. Different output voltages can be programmed with an additional resistor between FB and GND pins. In PolyPhase[®] operation, tying the FB pins together allows for parallel operation. See the Applications Information section for details.

COMP1 (E5), COMP2 (A5): Current Control Threshold and Error Amplifier Compensation Point of Each Switching Mode Regulator Channel. The current comparator's trip threshold is linearly proportional to this voltage, whose normal range is from 0.3V to 1.8V. Tie the COMP pins together for parallel operation. The device is internal compensated. Do not drive this pin.

BLOCK DIAGRAM

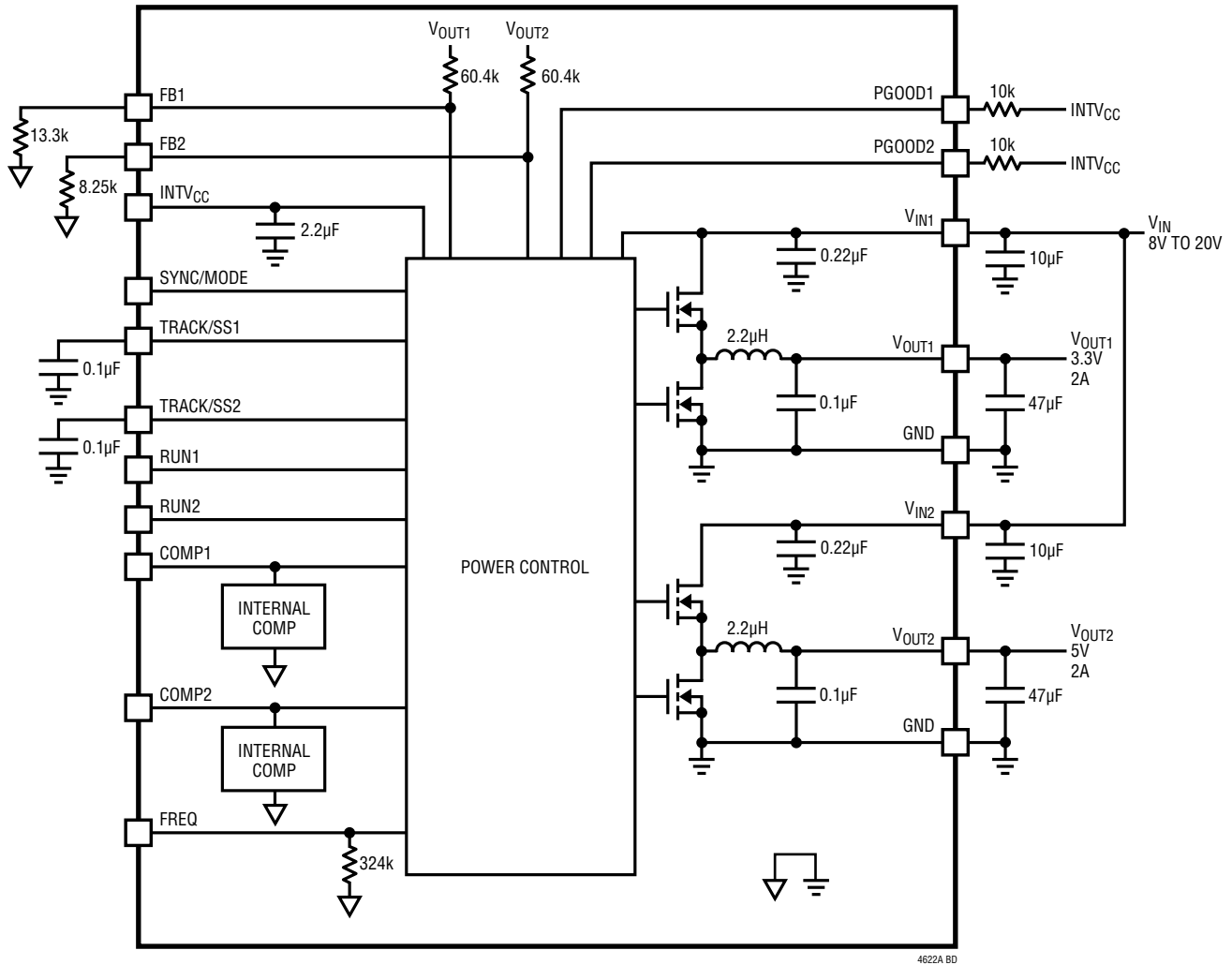

Figure 1. Simplified LTM4622A Block Diagram

DECOUPLING REQUIREMENTS

SYMBOL	PARAMETER	CONDITIONS	MIN	TYP	MAX	UNITS
C _{IN}	External Input Capacitor Requirement (V _{IN} = 3.6V to 20V, V _{OUT} = 1.5V)	I _{OUT} = 2A	4.7	10		μF
C _{OUT}	External Output Capacitor Requirement (V _{IN} = 3.6V to 20V, V _{OUT} = 1.5V)	I _{OUT} = 2A	22	47		μF

OPERATION

The LTM4622A is a dual output standalone non-isolated switch mode DC/DC power supply. It can deliver two 2A DC, 3A peak output current with few external input and output ceramic capacitors. This module provides dual precisely regulated output voltage programmable via two external resistor from 1.5V to 12V over 3.6V to 20V input voltage range. The typical application schematic is shown in Figure 27.

The LTM4622A contains an integrated controlled on-time valley current mode regulator, power MOSFETs, inductors, and other supporting discrete components. The default switching frequency is 1MHz. For output voltages above 3.3V, an external resistor is required between $FREQ$ and GND pins to set the operating frequency to 1.5MHz to 2MHz to optimize inductor current ripple. For switching noise-sensitive applications, the switching frequency can be adjusted by external resistors and the μ Module regulator can be externally synchronized to a clock within $\pm 30\%$ of the set frequency. See the Applications Information section.

With current mode control and internal feedback loop compensation, the LTM4622A module has sufficient stability margins and good transient performance with

a wide range of output capacitors, even with all ceramic output capacitors.

Current mode control provides cycle-by-cycle fast current limiting. An internal overvoltage and undervoltage comparators pull the open-drain $PGOOD$ output low if the output feedback voltage exits a $\pm 8\%$ window around the regulation point. Furthermore, an input overvoltage protection been utilized by shutting down both power MOSFETs when V_{IN} rises above 22.5V to protect internal devices.

Multiphase operation can be easily employed by connecting $SYNC$ pin to an external oscillator. Up to 6 phases can be paralleled to run simultaneously a good current sharing guaranteed by current mode control loop.

Pulling the RUN pin below 1V forces the controller into its shutdown state, turning off both power MOSFETs and most of the internal control circuitry. At light load currents, Burst Mode operation can be enabled to achieve higher efficiency compared to continuous mode (CCM) by setting $MODE$ pin to $INTV_{CC}$. The $TRACK/SS$ pin is used for power supply tracking and soft-start programming. See the Applications Information section.

APPLICATIONS INFORMATION

The typical LTM4622A application circuit is shown in Figure 27. External component selection is primarily determined by the input voltage, the output voltage and the maximum load current. Refer to Table 7 for specific external capacitor requirements for a particular application.

V_{IN} to V_{OUT} Step-Down Ratios

There are restrictions in the maximum V_{IN} and V_{OUT} step down ratio that can be achieved for a given input voltage due to the minimum off-time and minimum on-time limits of the regulator. The minimum off-time limit imposes a maximum duty cycle which can be calculated as:

$$DC_{(MAX)} = 1 - t_{OFF(MIN)} \cdot f_{SW}$$

where $t_{OFF(MIN)}$ is the minimum off-time, 45ns typical for LTM4622A, and f_{SW} is the switching frequency. Conversely the minimum on-time limit imposes a minimum duty cycle of the converter which can be calculated as:

$$DC_{(MIN)} = t_{ON(MIN)} \cdot f_{SW}$$

where $t_{ON(MIN)}$ is the minimum on-time, 20ns typical for LTM4622A. In the rare cases where the minimum duty cycle is surpassed, the output voltage will still remain in regulation, but the switching frequency will decrease from its programmed value. Note that additional thermal derating may be applied. See the Thermal Considerations and Output Current Derating section in this data sheet.

APPLICATIONS INFORMATION

Output Voltage Programming

The PWM controller has an internal 0.6V reference voltage. As shown in the Block Diagram, a 60.4k 0.5% internal feedback resistor connects V_{OUT} and FB pins together. Adding a resistor R_{FB} from FB pin to GND programs the output voltage:

$$R_{FB} = \frac{0.6V}{V_{OUT} - 0.6V} \cdot 60.4k$$

Table 1. V_{FB} Resistor Table vs Various Output Voltages (1% Resistor)

V_{OUT} (V)	1.5	1.8	2.5	3.3	5.0	8.0	10.0	12.0
R_{FB} (k)	40.2	30.1	19.1	13.3	8.25	4.87	3.83	3.16

Please note that for output above 3.3V, a higher operating frequency is required to optimize inductor current ripple. See Operating Frequency section.

For parallel operation of N-channels LTM4622A, the following equation can be used to solve for R_{FB} :

$$R_{FB} = \frac{0.6V}{V_{OUT} - 0.6V} \cdot \frac{60.4k}{N}$$

Input Decoupling Capacitors

The LTM4622A module should be connected to a low AC-impedance DC source. For each regulator channel, one piece 4.7 μ F input ceramic capacitor is required for RMS ripple current decoupling. Bulk input capacitor is only needed when the input source impedance is compromised by long inductive leads, traces or not enough source capacitance. The bulk capacitor can be an electrolytic aluminum capacitor and polymer capacitor.

Without considering the inductor current ripple, for each output, the RMS current of the input capacitor can be estimated as:

$$I_{CIN(RMS)} = \frac{I_{OUT(MAX)}}{\eta\%} \cdot \sqrt{D \cdot (1-D)}$$

where η is the estimated efficiency of the power module.

Output Decoupling Capacitors

With an optimized high frequency, high bandwidth design, only single piece of 47 μ F low ESR output ceramic capacitor is required for each LTM4622A output to achieve low output voltage ripple and very good transient response. Additional output filtering may be required by the system designer, if further reduction of output ripples or dynamic transient spikes is required. Table 7 shows a matrix of different output voltages and output capacitors to minimize the voltage droop and overshoot during a 1A (50%) load step transient. Multiphase operation will reduce effective output ripple as a function of the number of phases. [Application Note 77](#) discusses this noise reduction versus output ripple current cancellation, but the output capacitance will be more a function of stability and transient response. The Linear Technology LTpowerCAD[®] Design Tool is available to download online for output ripple, stability and transient response analysis and calculating the output ripple reduction as the number of phases implemented increases by N times.

Burst Mode Operation

In applications where high efficiency at intermediate current are more important than output voltage ripple, Burst Mode operation could be used by connecting SYNC/MODE pin to INTV_{CC} to improve light load efficiency. In Burst Mode operation, a current reversal comparator (I_{REV}) detects the negative inductor current and shuts off the bottom power MOSFET, resulting in discontinuous operation and increased efficiency. Both power MOSFETs will remain off and the output capacitor will supply the load current until the COMP voltage rises above the zero current level to initiate another cycle.

Force Continuous Current Mode (CCM) Operation

In applications where fixed frequency operation is more critical than low current efficiency, and where the lowest output ripple is desired, forced continuous operation should be used. Forced continuous operation can be enabled by tying the SYNC/MODE pin to GND. In this mode, inductor current is allowed to reverse during low output loads, the COMP voltage is in control of the current comparator threshold throughout, and the top MOSFET always turns

APPLICATIONS INFORMATION

on with each oscillator pulse. During start-up, forced continuous mode is disabled and inductor current is prevented from reversing until the LTM4622A's output voltage is in regulation.

Operating Frequency

The operating frequency of the LTM4622A is optimized to achieve the compact package size and the minimum output ripple voltage while still keeping high efficiency. The default operating frequency is internally set to 1MHz.

If any operating frequency other than 1MHz is required by application, the operating frequency can be increased by adding a resistor, R_{FSET} , between the FREQ pin and GND, as shown in Figure 29. The operating frequency can be calculated as:

$$f(\text{Hz}) = \frac{3.2e11}{324k \parallel R_{FSET} (\Omega)}$$

Please note a minimum switching frequency is required for given V_{IN} , V_{OUT} operating conditions to keep a maximum peak-to-peak inductor ripple current below 1.2A for the LTM4622A.

The peak-to-peak inductor ripple current can be calculated as:

$$\Delta I_{P-P} = \frac{V_{OUT}}{2.2} \left(1 - \frac{V_{OUT}}{V_{IN}} \right) \cdot \frac{1}{f_{SW}(\text{MHz})}$$

The maximum 1.2A peak-to-peak inductor ripple current is enforced due to the nature of the valley current mode control to maintain output voltage regulation at no load.

To reduce switching current ripple, 1.5MHz to 2MHz operating frequency is suggested for 5V and above output with R_{FSET} to GND.

V_{OUT}	1.5V to 3.3V	5V, 8V	12V
f_{SW}	1MHz	1.5MHz	1.5MHz to 2MHz

The operating frequency can also be decreased by adding a resistor between the FREQ pin and $INTV_{CC}$, calculated as:

$$f(\text{Hz}) = 1 \text{ MHz} - \frac{5.67e11}{R_{FSET} (\Omega)}$$

The programmable operating frequency range is from 800kHz to 4MHz.

Frequency Synchronization

The power module has a phase-locked loop comprised of an internal voltage controlled oscillator and a phase detector. This allows the internal top MOSFET turn-on to be locked to the rising edge of the external clock. The external clock frequency range must be within $\pm 30\%$ around the set operating frequency. A pulse detection circuit is used to detect a clock on the SYNC/MODE pin to turn on the phase-locked loop. The pulse width of the clock has to be at least 100ns. The clock high level must be above 2V and clock low level below 0.3V. The presence of an external clock will place both regulator channels into forced continuous mode operation. During the start-up of the regulator, the phase-locked loop function is disabled.

Multiphase Operation

For output loads that demand more than 2A of current, two outputs in the LTM4622A or even multiple LTM4622As can be paralleled to run out of phase to provide more output current without increasing input and output voltage ripples.

A multiphase power supply significantly reduces the amount of ripple current in both the input and output capacitors. The RMS input ripple current is reduced by, and the effective ripple frequency is multiplied by, the number of phases used (assuming that the input voltage is greater than the number of phases used times the output voltage). The output ripple amplitude is also reduced by the number of phases used when all of the outputs are tied together to achieve a single high output current design.

The two switching mode regulator channels inside the LTM4622A are internally set to operate 180° out of phase. Multiple LTM4622As could easily operate 90 degrees, 60 degrees or 45 degrees shift which corresponds to 4-phase, 6-phase or 8-phase operation by letting SYNC/MODE of the LTM4622A synchronize to an external multiphase oscillator like LTC®6902. Figure 2 shows a 4-phase design example for clock phasing.

APPLICATIONS INFORMATION

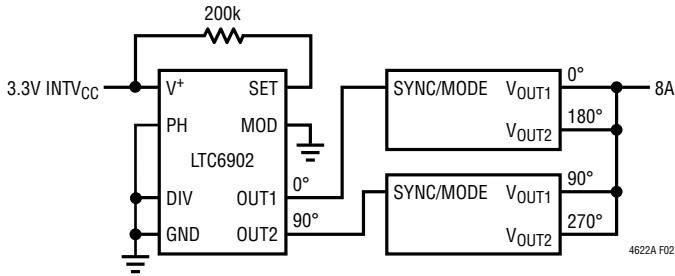

Figure 2. Example of Clock Phasing for 4-Phase Operation with LTC6902

The LTM4622A device is an inherently current mode controlled device, so parallel modules will have very good current sharing. This will balance the thermals on the design. Please tie RUN, TRACK/SS, FB and COMP pin of each paralleling channel together. Figure 31 shows an example of parallel operation and pin connection.

INPUT RMS Ripple Current Cancellation

Application Note 77 provides a detailed explanation of multiphase operation. The input RMS ripple current cancellation mathematical derivations are presented, and a graph is displayed representing the RMS ripple current

reduction as a function of the number of interleaved phases. Figure 3 shows this graph.

Soft-Start and Output Voltage Tracking

The TRACK/SS pin provides a means to either soft-start the regulator or track it to a different power supply. A capacitor on the TRACK/SS pin will program the ramp rate of the output voltage. An internal 1.4µA current source will charge up the external soft-start capacitor towards INTV_{CC} voltage. When the TRACK/SS voltage is below 0.6V, it will take over the internal 0.6V reference voltage to control the output voltage. The total soft-start time can be calculated as:

$$t_{SS} = 0.6 \cdot \frac{C_{SS}}{1.4\mu A}$$

where C_{SS} is the capacitance on the TRACK/SS pin. Current foldback and force continuous mode are disabled during the soft-start process.

The LTM4622A has internal 400µs soft-start time when TRACK/SS leave floating.

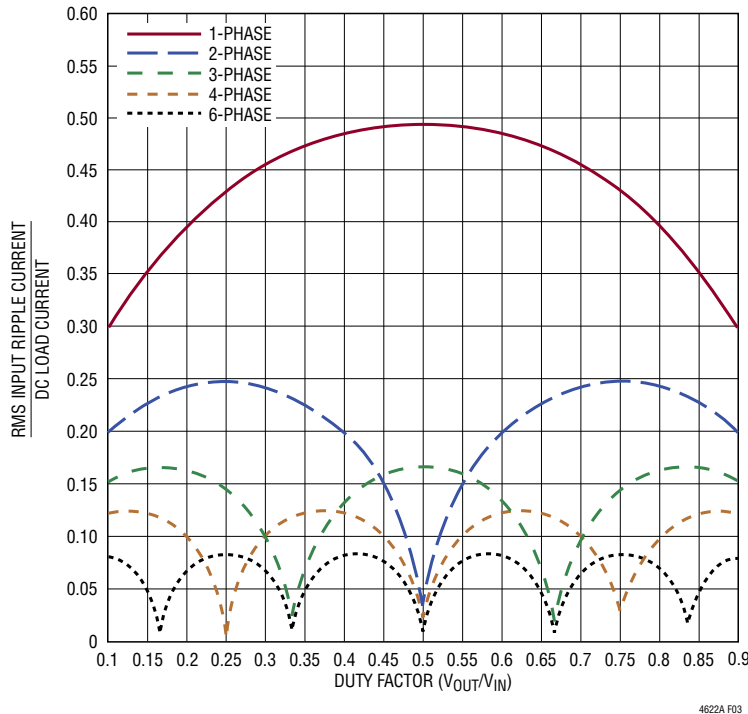

Figure 3. Input RMS Current Ratios to DC Load Current as a Function of Duty Cycle

APPLICATIONS INFORMATION

Output voltage tracking can also be programmed externally using the TRACK/SS pin. The output can be tracked up and down with another regulator. Figure 4 and Figure 5 show an example waveform and schematic of a Ratiometric tracking where the slave regulator's output slew rate is proportional to the master's.

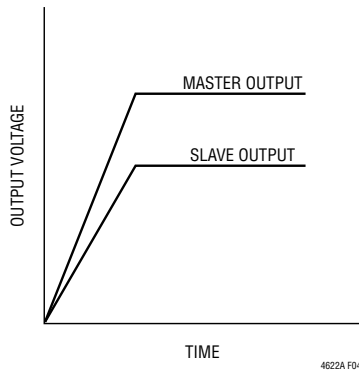

Figure 4. Output Ratiometric Tracking Waveform

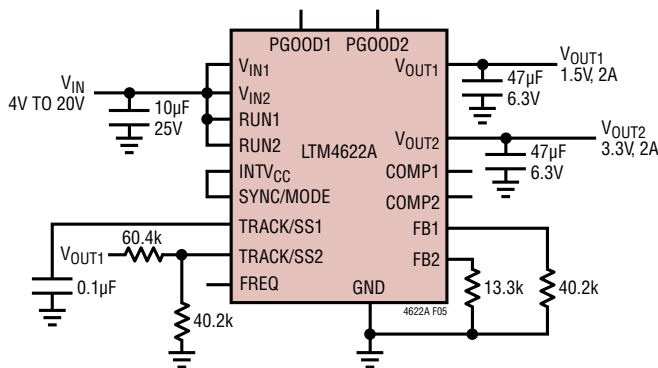

Figure 5. Example Schematic of Ratiometric Output Voltage Tracking

Since the slave regulator's TRACK/SS is connected to the master's output through a $R_{TR(TOP)}/R_{TR(BOT)}$ resistor divider and its voltage used to regulate the slave output voltage when TRACK/SS voltage is below 0.6V, the slave output voltage and the master output voltage should satisfy the following equation during the start-up.

$$V_{OUT(SL)} \cdot \frac{R_{FB(SL)}}{R_{FB(SL)} + 60.4k} = V_{OUT(MA)} \cdot \frac{R_{TR(TOP)}}{R_{TR(TOP)} + R_{TR(BOT)}}$$

The $R_{FB(SL)}$ is the feedback resistor and the $R_{TR(TOP)}/R_{TR(BOT)}$ is the resistor divider on the TRACK/SS pin of the slave regulator, as shown in Figure 5.

Following the upper equation, the master's output slew rate (MR) and the slave's output slew rate (SR) in Volts/Time is determined by:

$$\frac{MR}{SR} = \frac{\frac{R_{FB(SL)}}{R_{FB(SL)} + 60.4k}}{R_{TR(TOP)} + R_{TR(BOT)}}$$

For example, $V_{OUT(MA)} = 1.5V$, $MR = 1.5V/ms$ and $V_{OUT(SL)} = 3.3V$, $SR = 3.3V/ms$. From the equation, we could solve out that $R_{TR(TOP)} = 60.4k$ and $R_{TR(BOT)} = 40.2k$ is a good combination for the Ratiometric tracking.

The TRACK pins will have the $1.5\mu A$ current source on when a resistive divider is used to implement tracking on that specific channel. This will impose an offset on the TRACK pin input. Smaller values resistors with the same ratios as the resistor values calculated from the above equation can be used. For example, where the 60.4k is used then a 6.04k can be used to reduce the TRACK pin offset to a negligible value.

The Coincident output tracking can be recognized as a special Ratiometric output tracking which the master's output slew rate (MR) is the same as the slave's output slew rate (SR), as waveform shown in Figure 6.

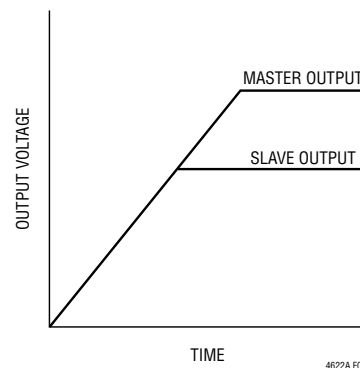

Figure 6. Output Coincident Tracking Waveform

APPLICATIONS INFORMATION

From the equation, we could easily find out that, in the coincident tracking, the slave regulator's TRACK/SS pin resistor divider is always the same as its feedback divider.

$$\frac{R_{FB(SL)}}{R_{FB(SL)} + 60.4k} = \frac{R_{TR(BOT)}}{R_{TR(TOP)} + R_{TR(BOT)}}$$

For example, $R_{TR(TOP)} = 60.4k$ and $R_{TR(BOT)} = 13.3k$ is a good combination for coincident tracking for $V_{OUT(MAX)} = 1.5V$ and $V_{OUT(SL)} = 3.3V$ application.

Power Good

The PGOOD pins are open drain pins that can be used to monitor valid output voltage regulation. This pin monitors a $\pm 8\%$ window around the regulation point. A resistor can be pulled up to a particular supply voltage for monitoring. To prevent unwanted PGOOD glitches during transients or dynamic V_{OUT} changes, the LTM4622A's PGOOD falling edge includes a blanking delay of approximately 40 μ s.

Stability compensation

The LTM4622A module internal compensation loop is designed and optimized for low ESR ceramic output capacitors only application. Table 7 is provided for most application requirements. The LTpowerCAD Design Tool is available to down for control loop optimization.

RUN Enable

Pulling the RUN pin to ground forces the LTM4622A into its shutdown state, turning off both power MOSFETs and most of its internal control circuitry. Trying the RUN pin voltage above 1.27V will turn on the entire chip.

Pre-Biased Output Start-Up

There may be situations that require the power supply to start up with a pre-bias on the output capacitors. In this case, it is desirable to start up without discharging that output pre-bias. The LTM4622A can safely power up into a pre-biased output without discharging it.

The LTM4622A accomplishes this by forcing discontinuous mode (DCM) operation until the TRACK/SS pin voltage reaches 0.6V reference voltage. This will prevent the BG from turning on during the pre-biased output start-up which would discharge the output.

Overtemperature Protection

The internal overtemperature protection monitors the junction temperature of the module. If the junction temperature reaches approximately 160°C, both power switches will be turned off until the temperature drops about 15°C cooler.

Input Overvoltage Protection

In order to protect the internal power MOSFET devices against transient voltage spikes, the LTM4622A constantly monitors each V_{IN} pin for an overvoltage condition. When V_{IN} rises above 22.5V, the regulator suspends operation by shutting off both power MOSFETs on the corresponding channel. Once V_{IN} drops below 21.5V, the regulator immediately resumes normal operation. The regulator executes its soft-start function when exiting an overvoltage condition.

Thermal Considerations and Output Current Derating

The thermal resistances reported in the Pin Configuration section of the data sheet are consistent with those parameters defined by JESD51-9 and are intended for use with finite element analysis (FEA) software modeling tools that leverage the outcome of thermal modeling, simulation, and correlation to hardware evaluation performed on a μ Module package mounted to a hardware test board—also defined by JESD51-9 (Test Boards for Area Array Surface Mount Package Thermal Measurements). The motivation for providing these thermal coefficients in found in JESD51-12 (Guidelines for Reporting and Using Electronic Package Thermal Information).

Many designers may opt to use laboratory equipment and a test vehicle such as the demo board to anticipate the μ Module regulator's thermal performance in their application at various electrical and environmental operating conditions to compliment any FEA activities. Without FEA

APPLICATIONS INFORMATION

software, the thermal resistances reported in the Pin Configuration section are in-and-of themselves not relevant to providing guidance of thermal performance; instead, the derating curves provided in the data sheet can be used in a manner that yields insight and guidance pertaining to one's application usage, and can be adapted to correlate thermal performance to one's own application.

The Pin Configuration section typically gives four thermal coefficients explicitly defined in JESD51-12; these coefficients are quoted or paraphrased below:

1. θ_{JA} , the thermal resistance from junction to ambient, is the natural convection junction-to-ambient air thermal resistance measured in a one cubic foot sealed enclosure. This environment is sometimes referred to as still air although natural convection causes the air to move. This value is determined with the part mounted to a JESD51-9 defined test board, which does not reflect an actual application or viable operating condition.
2. $\theta_{JCbottom}$, the thermal resistance from junction to ambient, is the natural convection junction-to-ambient air thermal resistance measured in a one cubic foot sealed enclosure. This environment is sometimes referred to as still air although natural convection causes the air to move. This value is determined with the part mounted to a JESD51-9 defined test board,

which does not reflect an actual application or viable operating condition.

3. θ_{JCTop} , the thermal resistance from junction to top of the product case, is determined with nearly all of the component power dissipation flowing through the top of the package. As the electrical connections of the typical μ Module are on the bottom of the package, it is rare for an application to operate such that most of the heat flows from the junction to the top of the part. As in the case of $\theta_{JCbottom}$, this value may be useful for comparing packages but the test conditions don't generally match the user's application.
4. θ_{JB} , the thermal resistance from junction to the printed circuit board, is the junction-to-board thermal resistance where almost all of the heat flows through the bottom of the μ Module and into the board, and is really the sum of the $\theta_{JCbottom}$ and the thermal resistance of the bottom of the part through the solder joints and through a portion of the board. The board temperature is measured a specified distance from the package, using a two sided, two layer board. This board is described in JESD51-9.

A graphical representation of the aforementioned thermal resistances is given in Figure 7; blue resistances are contained within the μ Module regulator, whereas green resistances are external to the μ Module.

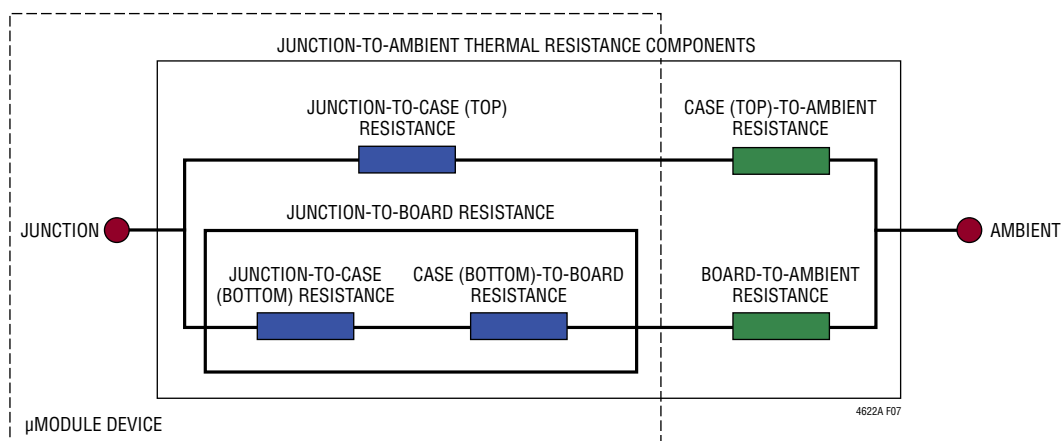

Figure 7. Graphical Representation of JESD51-12 Thermal Coefficients

APPLICATIONS INFORMATION

As a practical matter, it should be clear to the reader that no individual or sub-group of the four thermal resistance parameters defined by JESD51-12 or provided in the Pin Configuration section replicates or conveys normal operating conditions of a μ Module. For example, in normal board-mounted applications, never does 100% of the device's total power loss (heat) thermally conduct exclusively through the top or exclusively through bottom of the μ Module—as the standard defines for θ_{JCtop} and $\theta_{JCbottom}$, respectively. In practice, power loss is thermally dissipated in both directions away from the package—granted, in the absence of a heat sink and airflow, a majority of the heat flow is into the board.

Within a SIP (system-in-package) module, be aware there are multiple power devices and components dissipating power, with a consequence that the thermal resistances relative to different junctions of components or die are not exactly linear with respect to total package power loss. To reconcile this complication without sacrificing modeling simplicity—but also, not ignoring practical realities—an approach has been taken using FEA software modeling along with laboratory testing in a controlled-environment chamber to reasonably define and correlate the thermal resistance values supplied in this data sheet: (1) Initially, FEA software is used to accurately build the mechanical geometry of the μ Module and the specified PCB with all of the correct material coefficients along with accurate power loss source definitions; (2) this model simulates a software-defined JEDEC environment consistent with JESD51-12 to predict power loss heat flow and temperature readings at different interfaces that enable the calculation of the JEDEC-defined thermal resistance values; (3) the model and FEA software is used to evaluate the μ Module with heat sink and airflow; (4) having solved for and analyzed these thermal resistance values and simulated various operating conditions in the software model, a thorough laboratory evaluation replicates the simulated conditions with thermocouples within a controlled-environment chamber while operating the device at the same power loss as that which was simulated. An outcome of this process and due-diligence yields a set of derating curves provided in other sections of this data sheet. After these laboratory test have been performed and correlated to the μ Module model, then the θ_{JB} and θ_{BA} are summed together

to correlate quite well with the μ Module model with no airflow or heat sinking in a properly define chamber. This $\theta_{JB} + \theta_{BA}$ value is shown in the Pin Configuration section and should accurately equal the θ_{JA} value because approximately 100% of power loss flows from the junction through the board into ambient with no airflow or top mounted heat sink.

The 1.5V, 3.3V, 5V, 8V and 12V power loss curves in Figure 8 to Figure 12 can be used in coordination with the load current derating curves in Figure 13 to Figure 23 for calculating an approximate θ_{JA} thermal resistance for the LTM4622A (in two-phase single output operation) with no heat sinking and various airflow conditions. The power loss curves are taken at room temperature, and are increased with multiplicative factors of 1.35 assuming junction temperature at 120°C. The derating curves are plotted with the output current starting at 4A and the ambient temperature at 30°C. These output voltages are chosen to include the lower and higher output voltage ranges for correlating the thermal resistance. Thermal models are derived from several temperature measurements in a controlled temperature chamber along with thermal modeling analysis. The junction temperatures are monitored while ambient temperature is increased with and without airflow. The power loss increase with ambient temperature change is factored into the derating curves. The junctions are maintained at 120°C maximum while lowering output current or power with increasing ambient temperature. The decreased output current will decrease the internal module loss as ambient temperature is increased. The monitored junction temperature of 120°C minus the ambient operating temperature specifies how much module temperature rise can be allowed. As an example in Figure 16, the load current is derated to ~3A at ~100°C with 200LFM air but not heat sink and the power loss for the 5V to 3.3V at 3A output is about 1.15W. The 1.15W loss is calculated with the ~0.85W room temperature loss from the 5V to 3.3V power loss curve at 3A, and the 1.35 multiplying factor. If the 100°C ambient temperature is subtracted from the 120°C junction temperature, then the difference of 20°C divided by 1.15W equals a 17.5°C/W θ_{JA} thermal resistance. Table 3 specifies a 17°C/W – 18°C/W value which is very close. Tables 2 to 6 provide equivalent thermal resistances for 1.5V, 3.3V, 5V, 8V and 12V outputs with

APPLICATIONS INFORMATION

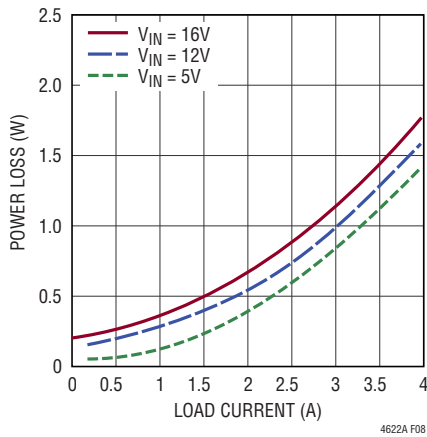

Figure 8. 1.5V Output Power Loss

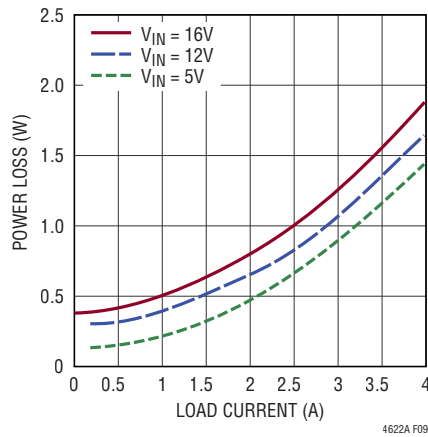

Figure 9. 3.3V Output Power Loss

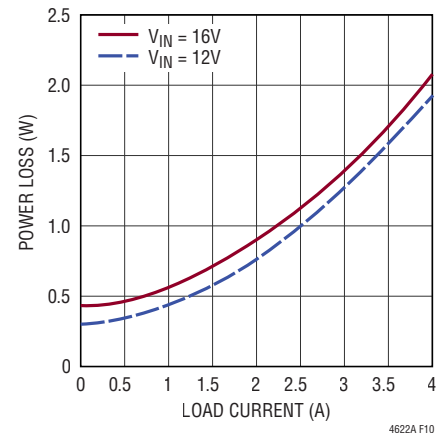

Figure 10. 5V Output Power Loss

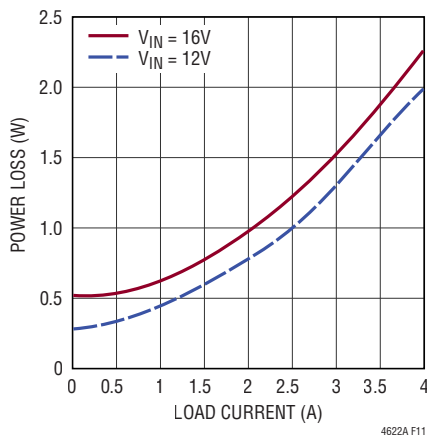

Figure 11. 8V Output Power Loss

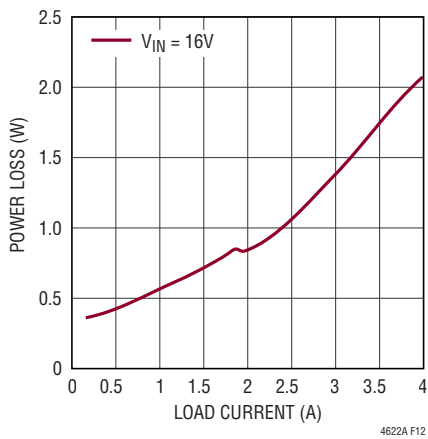

Figure 12. 12V Output Power Loss

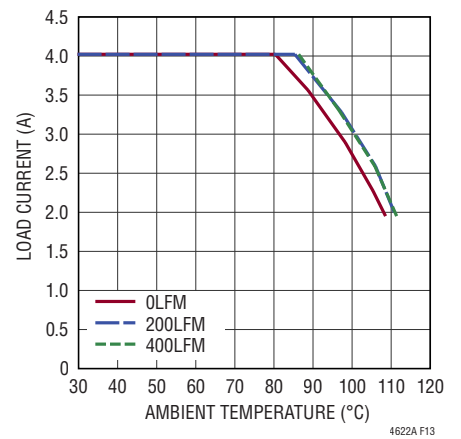

Figure 13. 5V Input to 1.5V Output Derating Curve, No Heat Sink

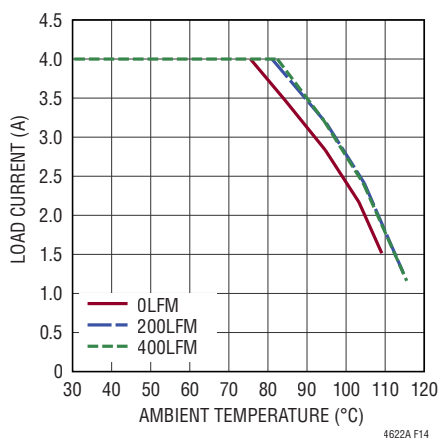

Figure 14. 12V Input to 1.5V Output Derating Curve, No Heat Sink

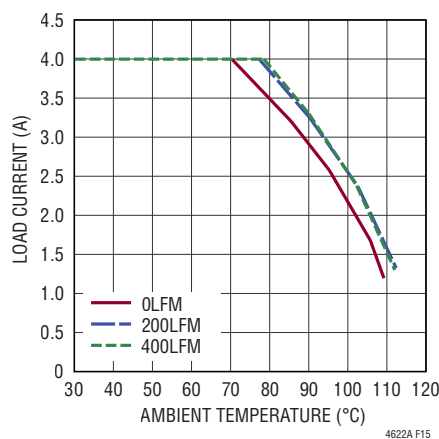

Figure 15. 16V Input to 1.5V Output Derating Curve, No Heat Sink

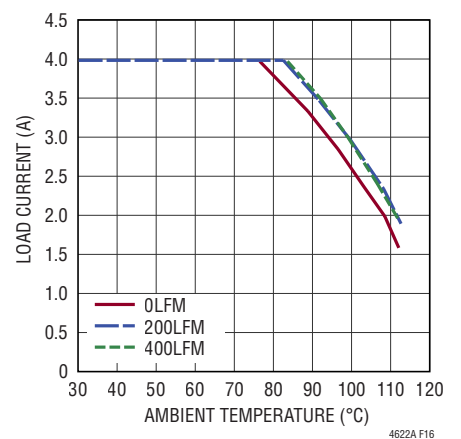

Figure 16. 5V Input to 3.3V Output Derating Curve, No Heat Sink

APPLICATIONS INFORMATION

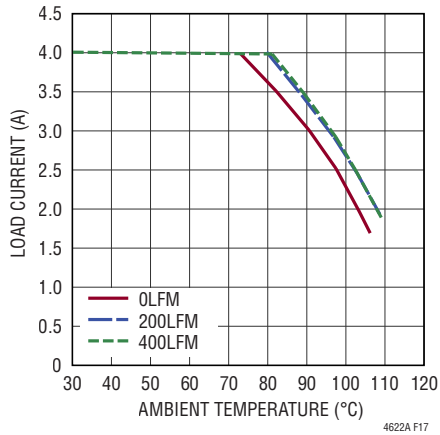

Figure 17. 12V Input to 3.3V Output Derating Curve, No Heat Sink

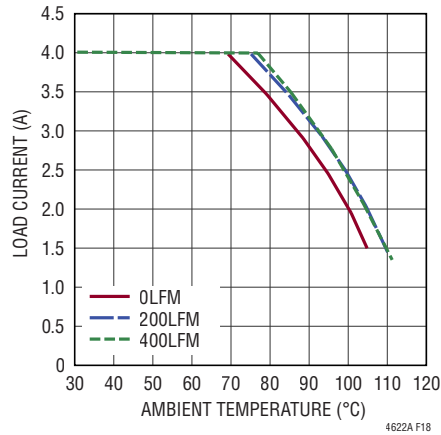

Figure 18. 16V Input to 3.3V Output Derating Curve, No Heat Sink

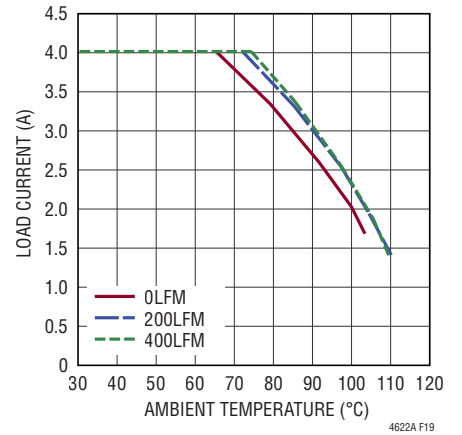

Figure 19. 12V Input to 5V Output Derating Curve, No Heat Sink

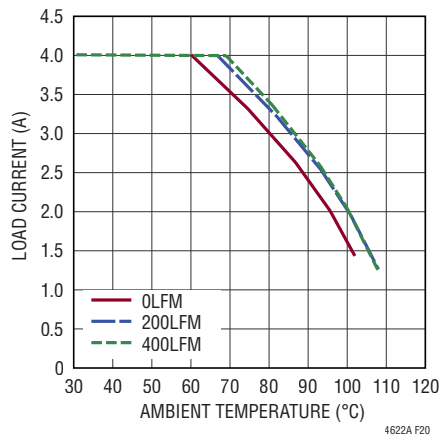

Figure 20. 16V Input to 5V Output Derating Curve, No Heat Sink

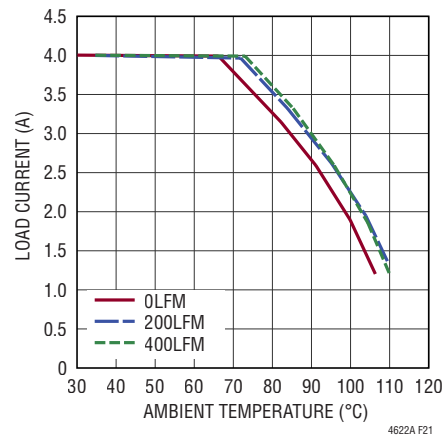

Figure 21. 12V Input to 8V Output Derating Curve, No Heat Sink

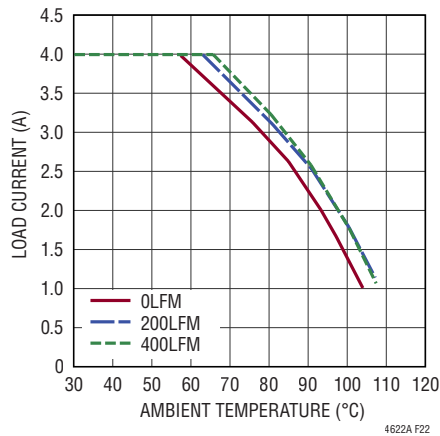

Figure 22. 16V Input to 8V Output Derating Curve, No Heat Sink

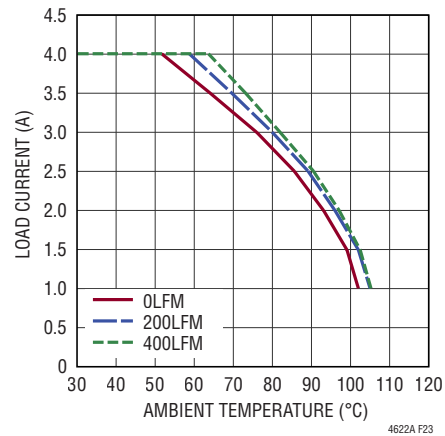

Figure 23. 16V Input to 12V Output Derating Curve, No Heat Sink

APPLICATIONS INFORMATION

Table 2. 1.5V Output

DERATING CURVE	V _{IN} (V)	POWER LOSS CURVE	AIRFLOW (LFM)	HEAT SINK	θ _{JA} (°C/W)
Figures 13, 14, 15	5, 12, 16	Figure 8	0	None	19–20
Figures 13, 14, 15	5, 12, 16	Figure 8	200	None	17–18
Figures 13, 14, 15	5, 12, 16	Figure 8	400	None	17–18

Table 3. 3.3V Output

DERATING CURVE	V _{IN} (V)	POWER LOSS CURVE	AIRFLOW (LFM)	HEAT SINK	θ _{JA} (°C/W)
Figures 16, 17, 18	5, 12, 16	Figure 9	0	None	19–20
Figures 16, 17, 18	5, 12, 16	Figure 9	200	None	17–18
Figures 16, 17, 18	5, 12, 16	Figure 9	400	None	17–18

Table 4. 5V Output

DERATING CURVE	V _{IN} (V)	POWER LOSS CURVE	AIRFLOW (LFM)	HEAT SINK	θ _{JA} (°C/W)
Figures 19, 20	12, 16	Figure 10	0	None	19–20
Figures 19, 20	12, 16	Figure 10	200	None	17–18
Figures 19, 20	12, 16	Figure 10	400	None	17–18

Table 5. 8V Output

DERATING CURVE	V _{IN} (V)	POWER LOSS CURVE	AIRFLOW (LFM)	HEAT SINK	θ _{JA} (°C/W)
Figures 21, 22	5, 12	Figure 11	0	None	19–20
Figures 21, 22	5, 12	Figure 11	200	None	17–18
Figures 21, 22	5, 12	Figure 11	400	None	17–18

Table 6. 12V Output

DERATING CURVE	V _{IN} (V)	POWER LOSS CURVE	AIRFLOW (LFM)	HEAT SINK	θ _{JA} (°C/W)
Figure 23	5, 12	Figure 12	0	None	19–20
Figure 23	5, 12	Figure 12	200	None	17–18
Figure 23	5, 12	Figure 12	400	None	17–18

APPLICATIONS INFORMATION

Table 7. Output Voltage Response for Each Regulator Channel vs Component Matrix (Refer to Figure 24)
1.0A Load Step Typical Measured Values

C _{IN} (CERAMIC)	PART NUMBER	VALUE	C _{OUT1} (CERAMIC)	PART NUMBER	VALUE	C _{OUT2} (BULK)	PART NUMBER	VALUE
Murata	GRM188R61E475KE11#	4.7μF, 25V, 0603, X5R	Murata	GRM21R60J476ME15#	47μF, 6.3V, 0805, X5R	Panasonic	6TPC150M	150μF, 6.3V 3.5 × 2.8 × 1.4mm
Murata	GRM188R61E106MA73#	10μF, 25V, 0603, X5R	Murata	GRM188R60J226MEA0#	22μF, 6.3V, 0603, X5R			
Taiyo Yuden	TMK212BJ475KG-T	4.7μF, 25V, 0805, X5R	Taiyo Yuden	JMK212BJ476MG-T	47μF, 6.3V, 0805, X5R			

V _{OUT} (V)	C _{IN} (CERAMIC) (μF)	C _{IN} (BULK)	C _{OUT1} (CERAMIC) (μF)	C _{OUT2} (BULK) (μF)	C _{FF} (pF)	V _{IN} (V)	DROOP (mV)	P-P DERIVATION (mV)	RECOVERY TIME (μs)	LOAD STEP (A)	LOAD STEP SLEW RATE (A/μs)	R _{FB} (kΩ)
1.5	10	0	1 × 47	0	10	5, 12	0	89	10	1.0	10	40.2
1.5	10	0	1 × 4.7	150	0	5, 12	0	75	20	1.0	10	40.2
2.5	10	0	1 × 47	0	10	5, 12	0	112	10	1.0	10	19.1
2.5	10	0	1 × 4.7	150	0	5, 12	0	92	25	1.0	10	19.1
3.3	10	0	1 × 47	0	10	5, 12	0	144	15	1.0	10	13.3
3.3	10	0	1 × 4.7	150	0	5, 12	0	104	30	1.0	10	13.3
5	10	0	2 × 47	0	10	12	0	157	25	1.0	10	8.25
5	10	0	1 × 4.7	150	0	12	0	137	50	1.0	10	8.25
8	10	0	2 × 47	0	10	12	0	234	50	1.0	10	4.87
8	10	0	2 × 4.7	150	0	12	0	149	70	1.0	10	4.87
12	10	0	3 × 47	0	10	16	0	301	50	1.0	10	3.16
12	10	0	3 × 4.7	150	0	16	0	177	80	1.0	10	3.16

APPLICATIONS INFORMATION

and without airflow. The derived thermal resistances in Tables 2 to 6 for the various conditions can be multiplied by the calculated power loss as a function of ambient temperature to derive temperature rise above ambient, thus maximum junction temperature. Room temperature power loss can be derived from the efficiency curves in the Typical Performance Characteristics section and adjusted with the above ambient temperature multiplicative factors. The printed circuit board is a 1.6mm thick four layer board with two ounce copper for the two outer layers and one ounce copper for the two inner layers. The PCB dimensions are 95mm × 76mm.

Figure 24 and Figure 25 show measured temperature picture of the LTM4622A with no heat sink from 12V input down to 3.3V and 5V output with 2A DC current on each and from 12V down to 5V and 8V output with 2A DC current on each. Both without heat sink and airflow.

SAFETY CONSIDERATIONS

The LTM4622A modules do not provide galvanic isolation from V_{IN} to V_{OUT} . There is no internal fuse. If required, a slow blow fuse with a rating twice the maximum input current needs to be provided to protect each unit from catastrophic failure. The device does support thermal shutdown and over current protection.

APPLICATIONS INFORMATION

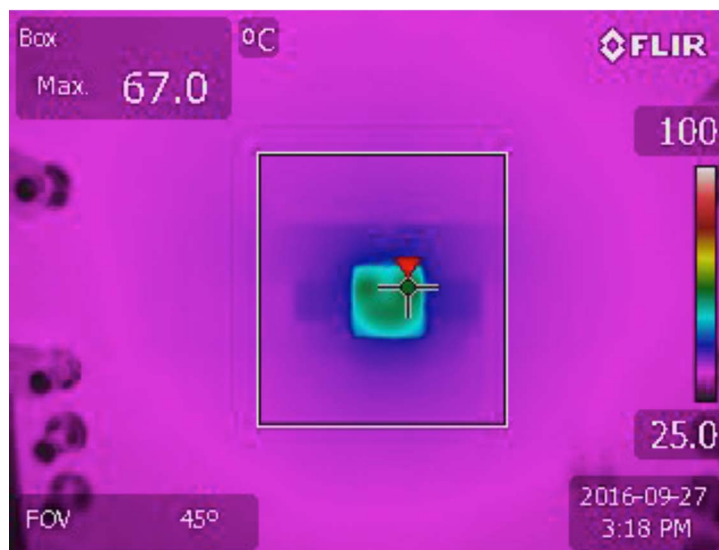

Figure 24. Thermal Image, 12V Input, 3.3V and 5V Output, 2A Each, No Airflow and No Heat Sink

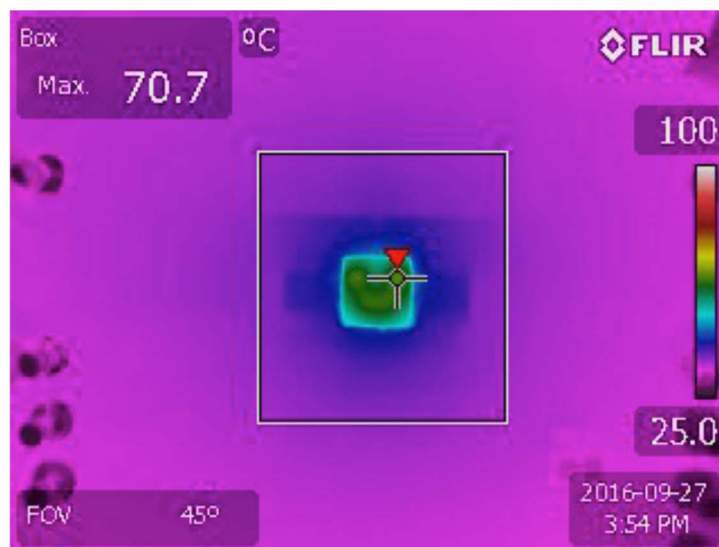

Figure 25. Thermal Image, 12V Input, 5V and 8V Output, 2A Each, No Airflow and No Heat Sink

APPLICATIONS INFORMATION

LAYOUT CHECKLIST/EXAMPLE

The high integration of LTM4622A makes the PCB board layout very simple and easy. However, to optimize its electrical and thermal performance, some layout considerations are still necessary.

- Use large PCB copper areas for high current paths, including V_{IN1} , V_{IN2} , GND, V_{OUT1} and V_{OUT2} . It helps to minimize the PCB conduction loss and thermal stress.
- Place high frequency ceramic input and output capacitors next to the V_{IN} , PGND and V_{OUT} pins to minimize high frequency noise.
- Place a dedicated power ground layer underneath the unit.
- The two dedicated input decoupling capacitors, one for each V_{IN} , closely placed on each side of the module.
- To minimize the via conduction loss and reduce module thermal stress, use multiple vias for interconnection between top layer and other power layers.
- Do not put via directly on the pad, unless they are capped or plated over.
- Use a separated SGND ground copper area for components connected to signal pins. Connect the SGND to GND underneath the unit.
- For parallel modules, tie the V_{OUT} , V_{FB} , and COMP pins together. Use an internal layer to closely connect these pins together. The TRACK pin can be tied a common capacitor for regulator soft-start.
- Bring out test points on the signal pins for monitoring.

Figure 26 gives a good example of the recommended layout.

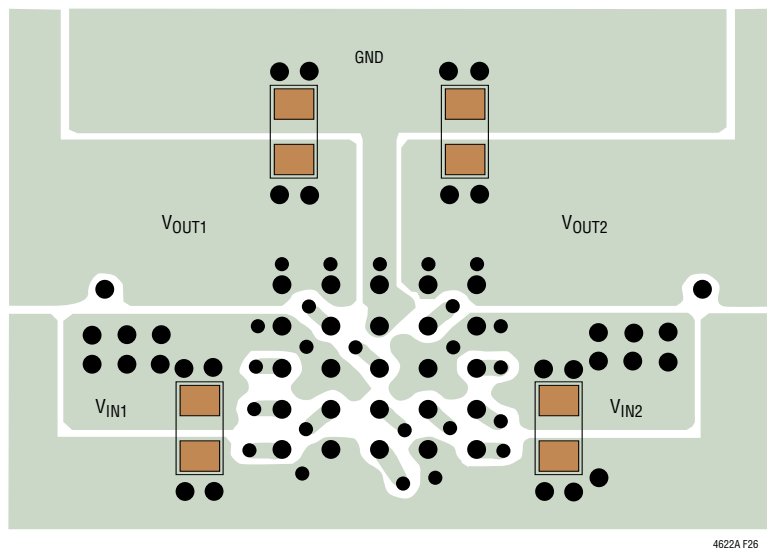

Figure 26. Recommended PCB Layout

APPLICATIONS INFORMATION

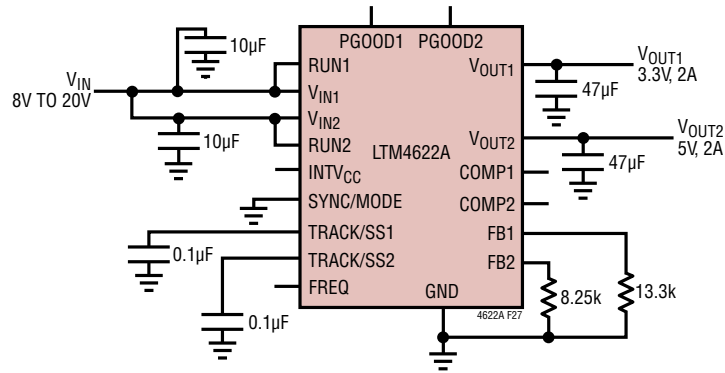

Figure 27. 8V_{IN} to 20V_{IN}, 3.3V and 5V Output at 2A Design

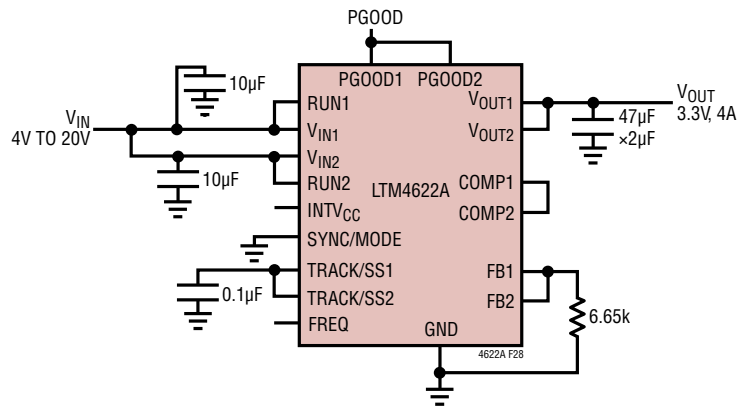

Figure 28. 4V_{IN} to 20V_{IN}, 3.3V Two Phase in Parallel 4A Design

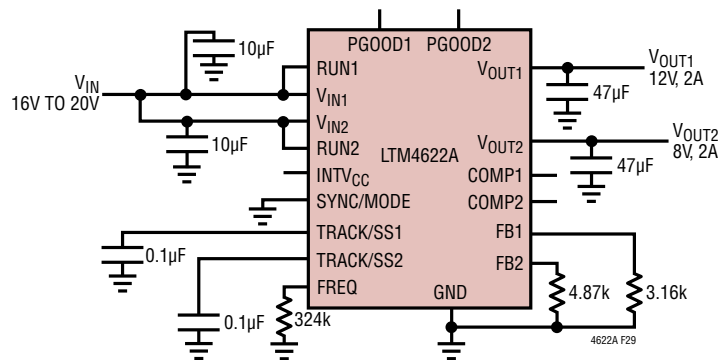

Figure 29. 16V_{IN} to 20V_{IN}, 12V and 8V Output at 2A with 2MHz Switching Frequency

APPLICATIONS INFORMATION

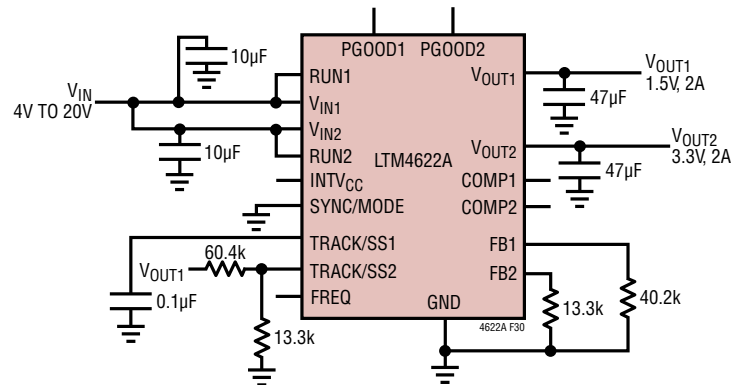

Figure 30. $4V_{IN}$ to $20V_{IN}$, 1.5V and 3.3V Output at 2A Design with Output Coincident Tracking

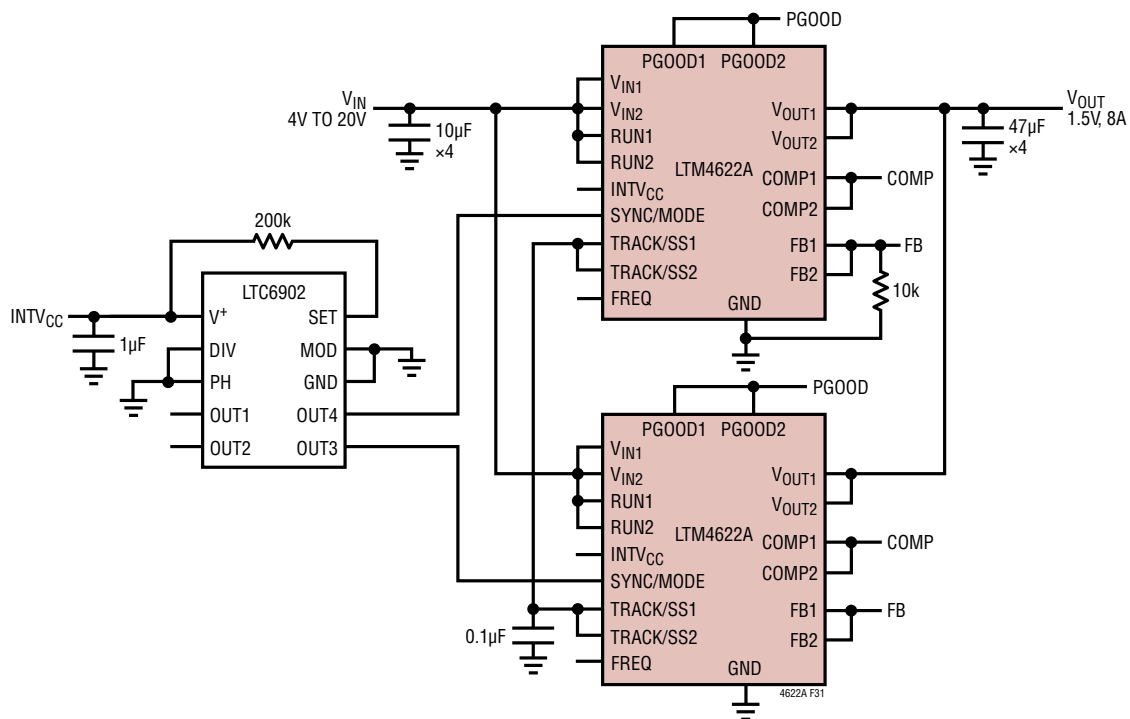

Figure 31. 4 Phase, 1.5V Output at 8A Design with LTC6902

PACKAGE DESCRIPTION



PACKAGE ROW AND COLUMN LABELING MAY VARY
AMONG μ Module PRODUCTS. REVIEW EACH PACKAGE
LAYOUT CAREFULLY.

LTM4622A Component LGA and BGA Pinout

PIN ID	FUNCTION	PIN ID	FUNCTION	PIN ID	FUNCTION	PIN ID	FUNCTION	PIN ID	FUNCTION
A1	V _{OUT2}	A2	V _{IN2}	A3	TRACK/SS2	A4	FB2	A5	COMP2
B1	V _{OUT2}	B2	RUN2	B3	V _{IN2}	B4	PGOOD2	B5	GND
C1	GND	C2	GND	C3	INTV _{CC}	C4	FREQ	C5	SYNC/MODE
D1	V _{OUT1}	D2	RUN1	D3	V _{IN1}	D4	PGOOD1	D5	GND
E1	V _{OUT1}	E2	V _{IN1}	E3	TRACK/SS1	E4	FB1	E5	COMP1

PACKAGE DESCRIPTION

Please refer to <http://www.linear.com/product/LTM4622A#packaging> for the most recent package drawings.

LGA Package 25-Lead (6.25mm × 6.25mm × 1.82mm) (Reference LTC DWG # 05-08-1949 Rev 0)

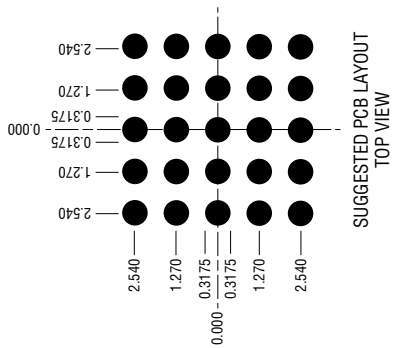
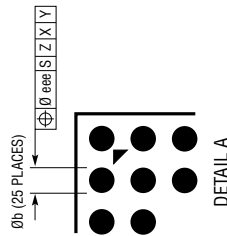
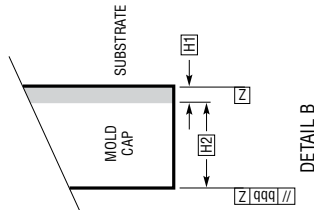
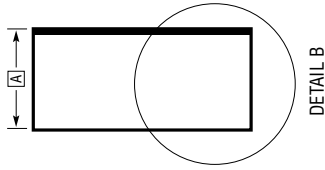
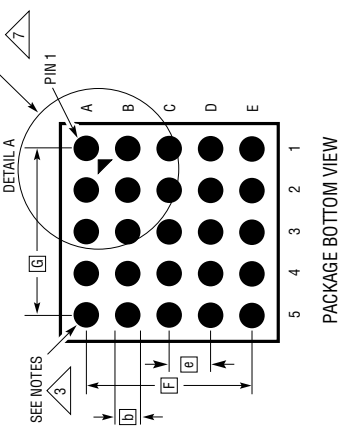
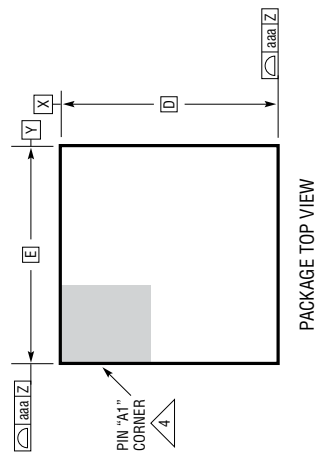

- NOTES:
1. DIMENSIONING AND TOLERANCING PER ASME Y14.5M-1994
 2. ALL DIMENSIONS ARE IN MILLIMETERS
 3. LAND DESIGNATION PER JEDEC MO-222, SPP-010
 4. DETAILS OF PAD #1 IDENTIFIER ARE OPTIONAL, BUT MUST BE LOCATED WITHIN THE ZONE INDICATED. THE PAD #1 IDENTIFIER MAY BE EITHER A MOLD OR MARKED FEATURE
 5. PRIMARY DATUM -Z- IS SEATING PLANE
 6. THE TOTAL NUMBER OF PADS: 25
 7. PACKAGE ROW AND COLUMN LABELING MAY VARY AMONG μ Module PRODUCTS. REVIEW EACH PACKAGE LAYOUT CAREFULLY

DIMENSIONS				NOTES
SYMBOL	MIN	NOM	MAX	
A	1.72	1.82	1.92	
b	0.60	0.63	0.66	
D		6.25		
E		6.25		
e		1.27		
F		5.08		
G		5.08		
H1	0.27	0.32	0.37	
H2	1.45	1.50	1.55	
aaa			0.15	
bbb			0.10	
eee			0.15	
TOTAL NUMBER OF LGA PADS: 25				

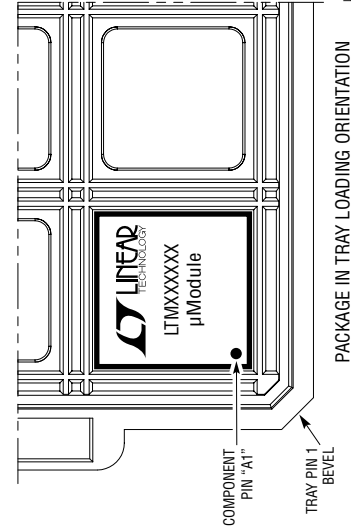

LGA-25 0613 REV. 0

PACKAGE DESCRIPTION

Please refer to <http://www.linear.com/product/LTM4622A#packaging> for the most recent package drawings.

BGA Package 25-Lead (6.25mm × 6.25mm × 2.42mm) (Reference LTC DWG # 05-08-1502 Rev A)

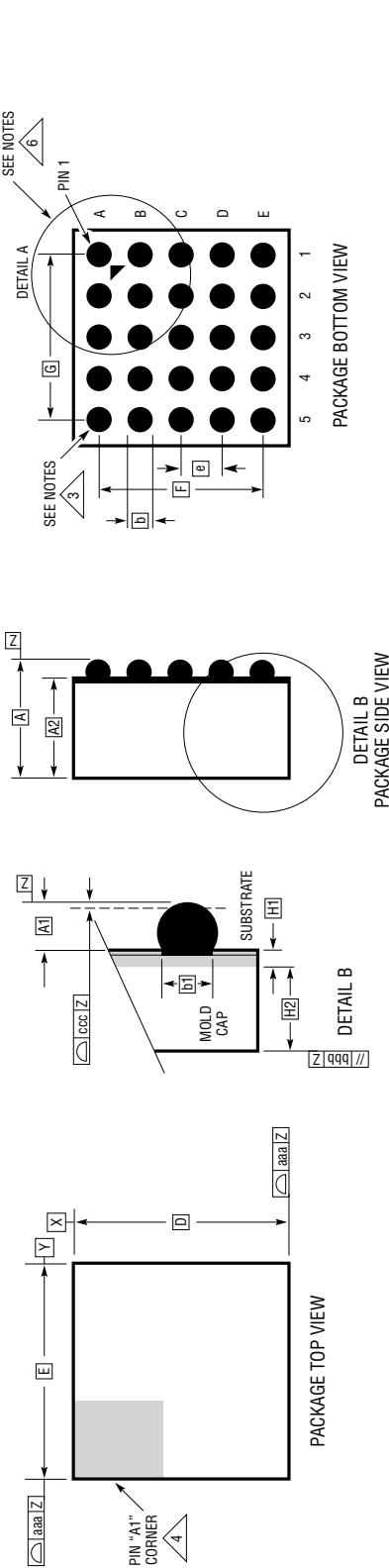

- NOTES:
1. DIMENSIONING AND TOLERANCING PER ASME Y14.5M-1994
 2. ALL DIMENSIONS ARE IN MILLIMETERS
 3. BALL DESIGNATION PER JESD MS-028 AND JEP95
 4. DETAILS OF PIN #1 IDENTIFIER ARE OPTIONAL, BUT MUST BE LOCATED WITHIN THE ZONE INDICATED. THE PIN #1 IDENTIFIER MAY BE EITHER A MOLD OR MARKED FEATURE
 5. PRIMARY DATUM -Z- IS SEATING PLANE
 6. PACKAGE ROW AND COLUMN LABELING MAY VARY AMONG μ Module PRODUCTS. REVIEW EACH PACKAGE LAYOUT CAREFULLY

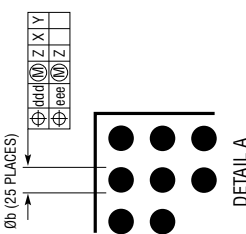

DIMENSIONS				
SYMBOL	MIN	NOM	MAX	NOTES
A	2.22	2.42	2.62	
A1	0.50	0.60	0.70	BALL HT
A2	1.72	1.82	1.92	
b	0.60	0.75	0.90	BALL DIMENSION
b1	0.60	0.63	0.66	PAD DIMENSION
D	6.25			
E	6.25			
e	1.27			
F	5.08			
G	5.08			
H1	0.27	0.32	0.37	SUBSTRATE THK
H2	1.45	1.50	1.55	MOLD CAP HT
aaa				0.15
bbb				0.10
ccc				0.20
ddd				0.30
eee				0.15
				TOTAL NUMBER OF BALLS: 25

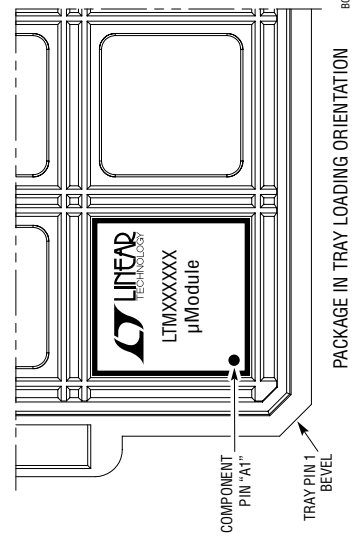

BGA 25 0517 REV A

REVISION HISTORY

REV	DATE	DESCRIPTION	PAGE NUMBER
A	11/17	Corrected Pin Configuration. Swapped V_{IN1} and V_{IN2} .	2
B	4/18	Corrected R_{FSET} to GND	9, 11

PACKAGE PHOTOS



DESIGN RESOURCES

SUBJECT	DESCRIPTION
μModule Design and Manufacturing Resources	<p>Design:</p> <ul style="list-style-type: none"> • Selector Guides • Demo Boards and Gerber Files • Free Simulation Tools <p>Manufacturing:</p> <ul style="list-style-type: none"> • Quick Start Guide • PCB Design, Assembly and Manufacturing Guidelines • Package and Board Level Reliability
μModule Regulator Products Search	<ol style="list-style-type: none"> 1. Sort table of products by parameters and download the result as a spread sheet. 2. Search using the Quick Power Search parametric table. <div style="border: 1px solid #ccc; padding: 5px; margin: 5px 0;"> <p>Quick Power Search</p> <p>Input V_{in} (Min) <input type="text"/> V V_{in} (Max) <input type="text"/> V</p> <p>Output V_{out} <input type="text"/> V I_{out} <input type="text"/> A</p> <p style="text-align: right;"><input type="button" value="Search"/></p> </div>
TechClip Videos	Quick videos detailing how to bench test electrical and thermal performance of μModule products.
Digital Power System Management	Linear Technology's family of digital power supply management ICs are highly integrated solutions that offer essential functions, including power supply monitoring, supervision, margining and sequencing, and feature EEPROM for storing user configurations and fault logging.

RELATED PARTS

PART NUMBER	DESCRIPTION	COMMENTS
LTM4614	Dual 5V, 4A μModule Regulator	$2.375V \leq V_{IN} \leq 5.5V$, $0.8V \leq V_{OUT} \leq 5V$, 15mm × 15mm × 2.82mm LGA
LTM4618	26V _{IN} , 6A Step-Down μModule Regulator	$4.5V \leq V_{IN} \leq 26.5V$, $0.8V \leq V_{OUT} \leq 5V$, PLL Input, V _{OUT} Tracking, 9mm × 15mm × 4.32mm LGA
LTM4619	Dual 26V, 4A Step-Down μModule Regulator	$4.5V \leq V_{IN} \leq 26.5V$, $0.8V \leq V_{OUT} \leq 5V$, PLL Input, V _{OUT} Tracking, PGOOD, 15mm × 15mm × 2.82mm LGA
LTM4622	Lower V _{OUT} than LTM4622A	$3.6V \leq V_{IN} \leq 20V$, $0.6V \leq V_{OUT} \leq 5.5V$, Pin Compatible with LTM4622A
LTM4623	20V _{IN} , 3A Step-Down μModule Regulator	$4V \leq V_{IN} \leq 20V$, $0.6V \leq V_{OUT} \leq 5.5V$, PLL Input, CLKOUT, V _{OUT} Tracking, PGOOD, 6.25mm × 6.25mm × 1.82mm LGA
LTM4624	14V _{IN} , 4A Step-Down μModule Regulator	$4V \leq V_{IN} \leq 14V$, $0.6V \leq V_{OUT} \leq 5.5V$, V _{OUT} Tracking, PGOOD, 6.25mm × 6.25mm × 5.01mm BGA
LTM4625	20V _{IN} , 5A Step-Down μModule Regulator	$4V \leq V_{IN} \leq 20V$, $0.6V \leq V_{OUT} \leq 5.5V$, PLL Input, CLKOUT, V _{OUT} Tracking, PGOOD, 6.25mm × 6.25mm × 5.01mm BGA
LTM4631	Ultrathin, Dual 10A Step-Down μModule Regulator	$4.5V \leq V_{IN} \leq 15V$, $0.6V \leq V_{OUT} \leq 1.8V$, 16mm × 16mm × 1.91mm LGA
LTM4642	20V _{IN} , Dual 4A, Step-Down μModule Regulator	$4.5V \leq V_{IN} \leq 20V$, $0.6V \leq V_{OUT} \leq 5.5V$, 9mm × 11.25mm × 4.92mm BGA
LTM4643	Ultrathin, Quad 3A, Step-Down μModule Regulator	$4V \leq V_{IN} \leq 20V$, $0.6V \leq V_{OUT} \leq 3.3V$, 9mm × 15mm × 1.82mm LGA
LTM4644	Quad 4A, Step-Down μModule Regulator	$4V \leq V_{IN} \leq 14V$, $0.6V$ to $5.5V$, 9mm × 15mm × 5.01mm BGA
LTC6902	Multiphase Oscillator with Spread Spectrum Frequency Modulation	1-, 3-, or 4-Phase Outputs; to 20MHz Frequency