

DESCRIPTION

The EVQ20051-Q-00A evaluation board demonstrates the performance of MPQ20051, a low noise and low dropout linear regulator. It operates from 2.5V to 5.5V input voltage and the output voltage can be set externally which ranges from 0.8V to 5V.

The EVQ20051-Q-00A can supply up to 1A of load current, and features current limiting, over temperature protection.

An internal PMOS pass element is used to allow a low 110µA ground current, marking the MPQ20051 suitable for battery-power devices.

ELECTRICAL SPECIFICATIONS

Parameter	Symbol	Value	Units
Input Voltage	V _{IN}	2.5 – 5.5	V
Output Voltage	V _{OUT}	1.1	V
Load Current	I _{OUT}	1	A

FEATURES

- Up to 1A Output Current
- Low 140mV Dropout at 1A
- Adjustable Output from 0.8V to 5V
- 63dB PSRR at 1kHz
- 13µVRMS Low Noise Output
- Very Fast Transient Responses
- Current Limit and Thermal Protection

APPLICATIONS

- Notebook Computers
- Cordless Telephones
- Cellular Phones
- Modems
- Hand-Held Instruments
- PDA and Palmtop Computers

All MPS parts are lead-free and adhere to the RoHS directive. For MPS green status, please visit MPS website under Quality Assurance. MPS® and "The Future of Analog IC Technology" are Registered Trademarks of Monolithic Power Systems, Inc.

EVQ20051-Q-00A EVALUATION BOARD



(L x W x H) 2.5" x 2.5" x 0.4"
(6.35cm x 6.35cm x 1.1cm)

Board Number	MPS IC Number
EVQ20051-Q-00A	MPQ20051DQ

EVALUATION BOARD SCHEMATIC

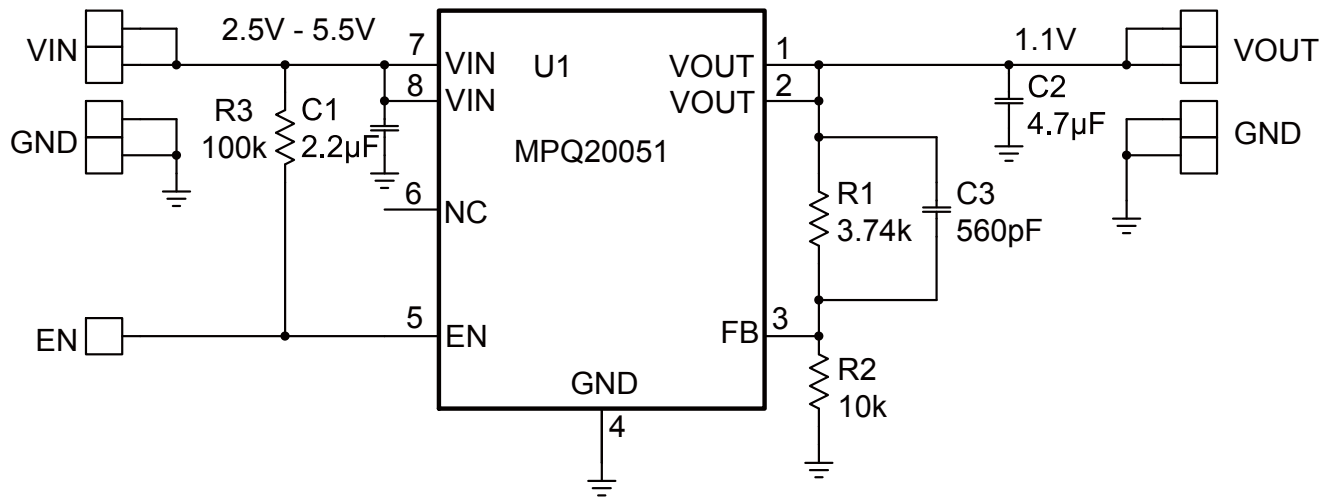

EVQ20051-Q-00A BILL OF MATERIALS

Qty	Ref	Value	Description	Package	Manufacturer	Part Number
1	C1	2.2uF	Ceramic Cap., 6.3V, 10%, X5R	0603	muRata	GRM188R60J225KE19D
1	C2	4.7uF	Ceramic Cap., 6.3V, 10%, X5R	0603	muRata	GRM188R60J475KE19D
1	C3	560pF	Ceramic Cap., 50V, 5%, NP0	0603	muRata	GRM1885C1H561JA01J
1	R1	3.74KΩ	Film Res., 1%	0603	Yageo	RC0603FR-073K74L
1	R2	10KΩ	Film Res., 1%	0603	Yageo	RC0603JR-0710KL
	R3	100kΩ	Film Res., 1%	0603	Yageo	RC0603JR-07100KL
1	U1		Linear Regulator	QFN8	MPS	MPQ20051DQ
4	VIN, VOUT, GND	Test Point	Test Point	2x2.54mm	HZ	China market
1	EN	Test Point	Test Point	Test Point	HZ	China market

EVB TEST RESULTS

$V_{IN}=2.3V$, $V_{OUT}=1.1V$, $T_A=25^\circ C$ Unless otherwise noted.

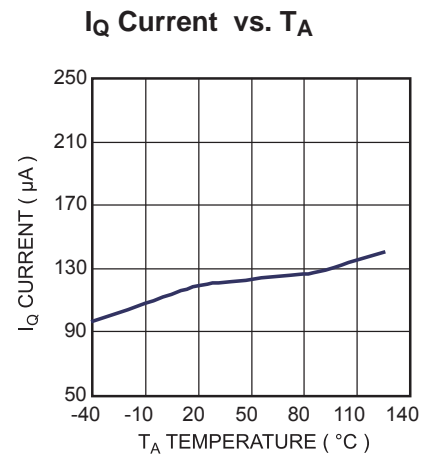
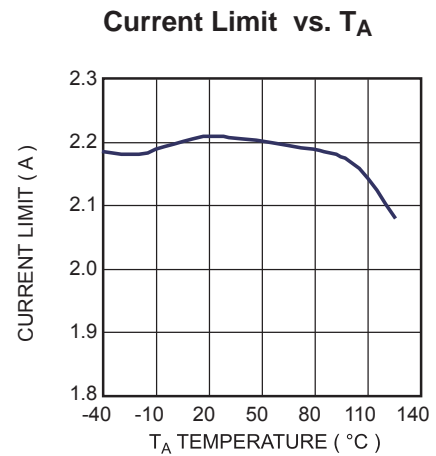
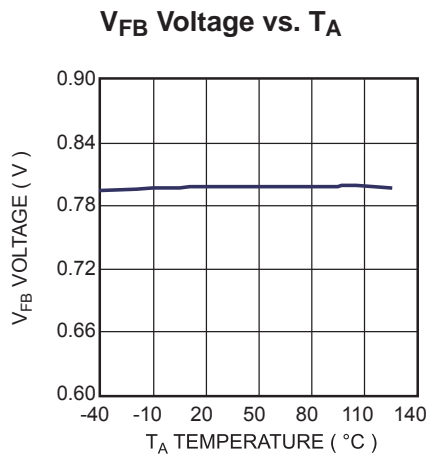
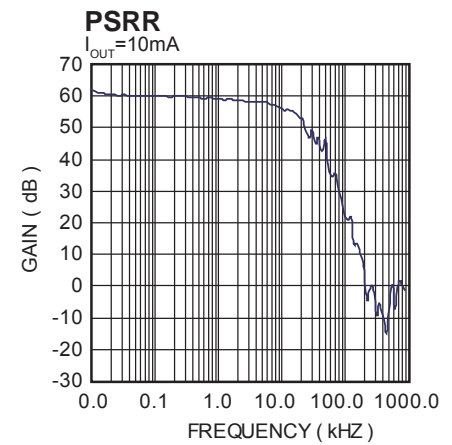
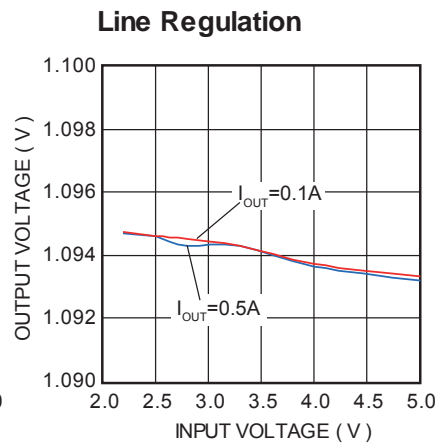
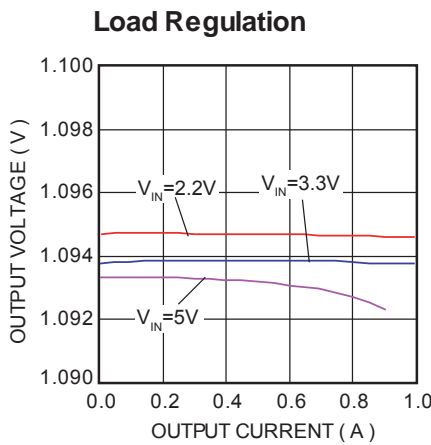
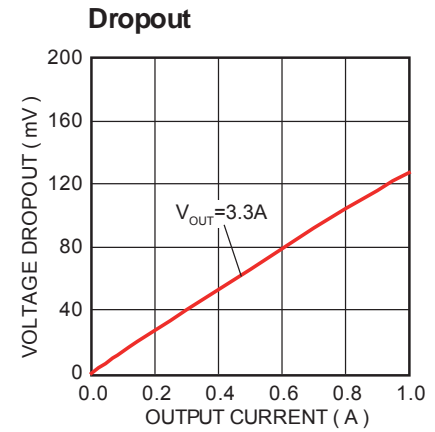
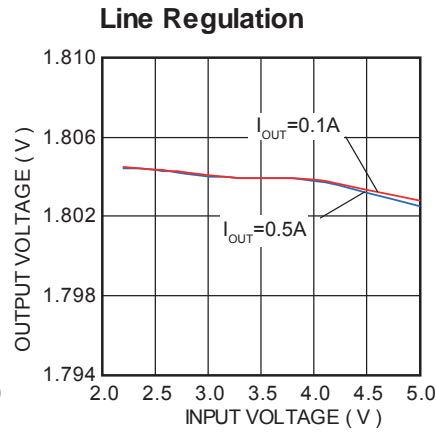
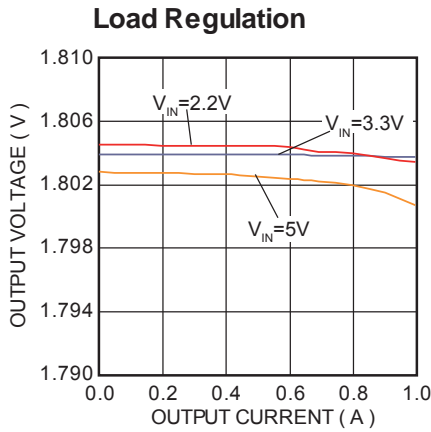

EVB TEST RESULTS (CONTINUED)

$V_{IN}=2.3V$, $V_{OUT}=1.1V$, $T_A=25^{\circ}C$ Unless otherwise noted.

Steady State
 $I_{OUT} = 1A$

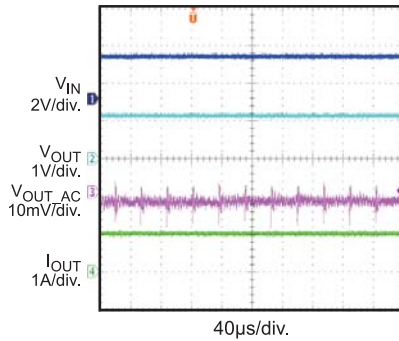

Steady State
 $I_{OUT} = 0.1A$

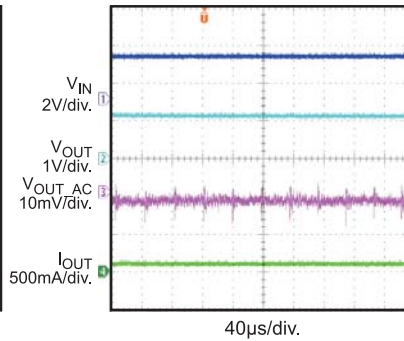

Load Transient
 $V_{IN} = 2.5V$, $V_{OUT} = 1.8V$
 $I_{OUT} = 0.1A-1A$

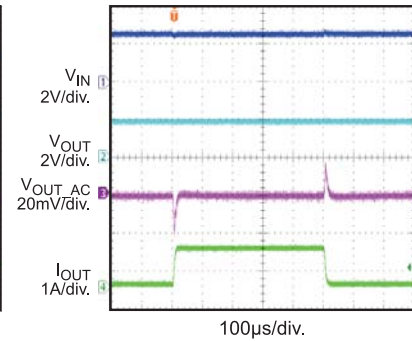

Enable On
 $I_{OUT} = 1A$

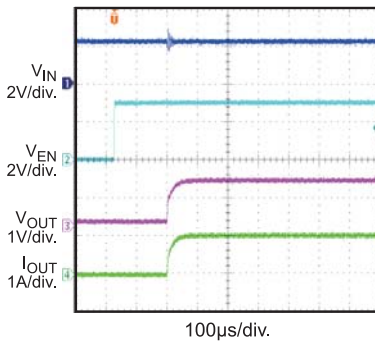

Enable Off
 $I_{OUT} = 1A$

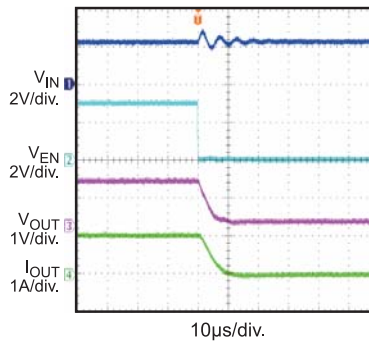

Short Output
 $V_{IN} = 2.5V$

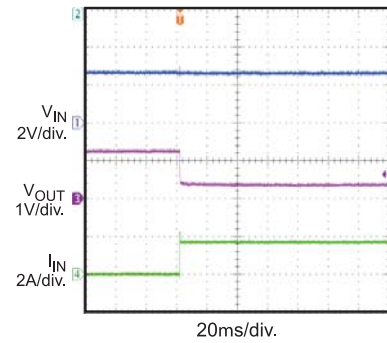

Power Ramp Up
 $I_{OUT} = 1A$

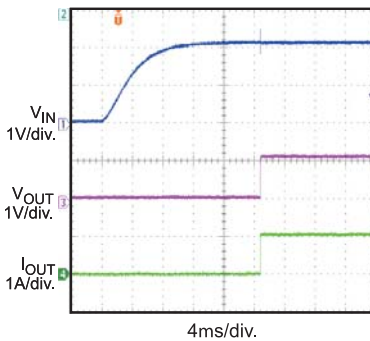

Power Ramp Down
 $I_{OUT} = 1A$

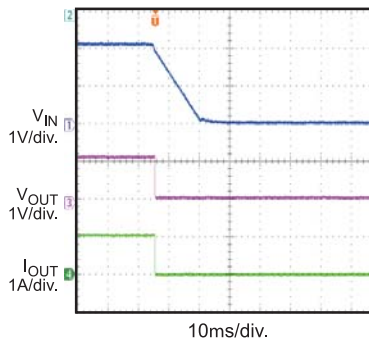

Short Output Recovery
 $V_{IN} = 2.5V$

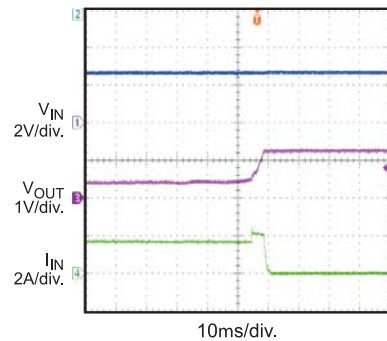

PRINTED CIRCUIT BOARD LAYOUT

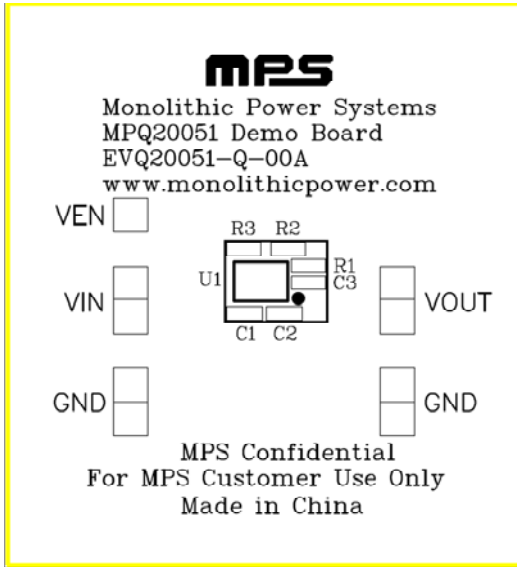

Figure 1—Top Layer and Top Silk Layer

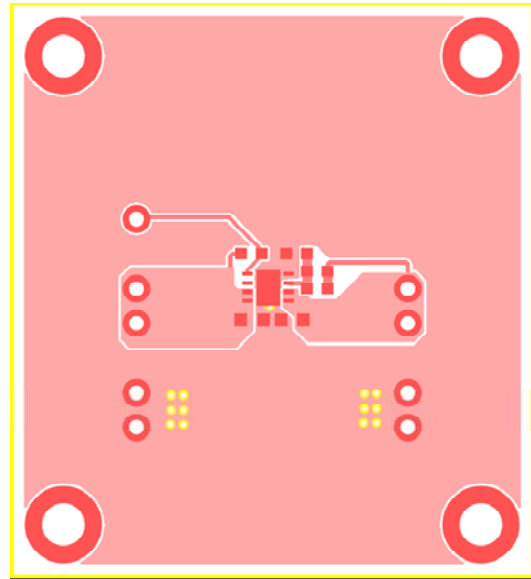

Figure 2—Bottom Layer

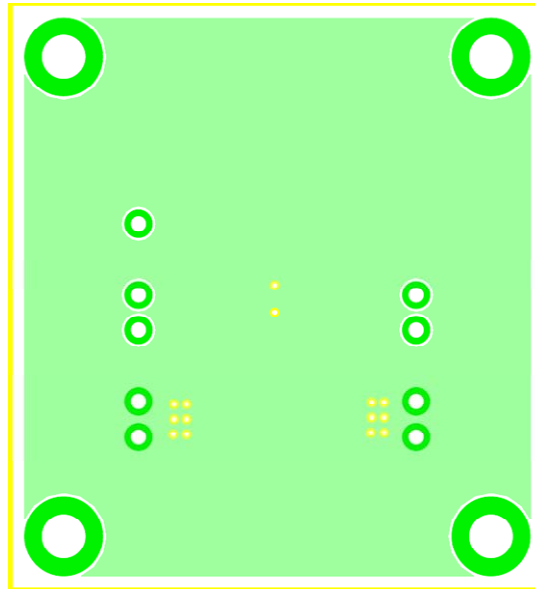

Figure 3—Top Silk Layer

QUICK START GUIDE (ADJUSTABLE OUTPUT)

The output voltage of this board is set externally which ranges from 0.8V to 5V by operating from +2.5V to +5.5V input as the figure 4. The default output voltage of this board is set to 1.1V.

The board layout accommodates most commonly used resistors and capacitors.

1. Attach the positive and negative ends of the load to the VOUT and GND pins, respectively.
2. Attach the Input Voltage ($2.5V \leq V_{IN} \leq 5.5V$) and Input Ground to the VIN and GND pins respectively.
3. To enable the MPQ20051, apply a voltage $1.5V \leq V_{EN} \leq 5.5V$, to the EN pin. To disable the MPQ20051, apply a voltage, $V_{EN} < 0.4V$, to the EN pin. The EN pin can be connected to V_{IN} with a 100k Ω resistor for automatic startup.
4. The Output Voltage V_{OUT} can be changed by varying R1. Calculate the new value by formula:

$$R1 = R2 \left(\frac{V_{OUT}}{V_{FB}} - 1 \right)$$

Where $V_{FB} = 0.8V$ and $R2 = 10k\Omega$.

Example:

For $V_{OUT} = 1.1V$:

$$R1 = 10k\Omega \left(\frac{1.1}{0.8} - 1 \right) = 3.75k\Omega$$

Therefore, use a 3.74k Ω standard 1% value.

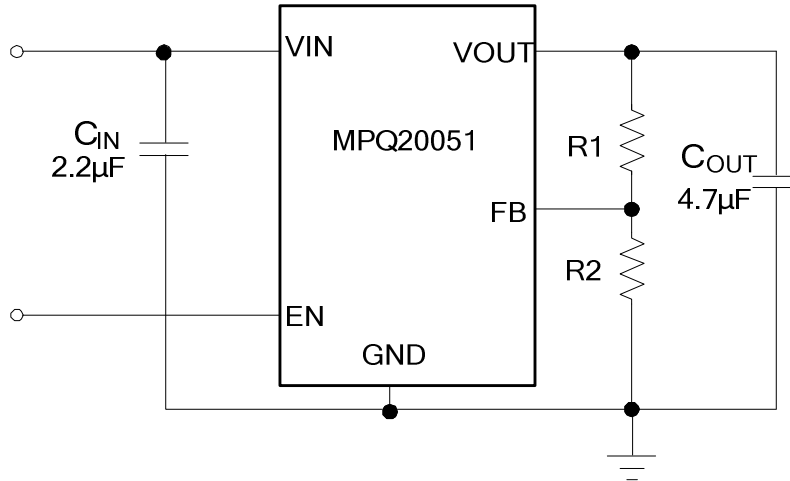

Figure 4

NOTICE: The information in this document is subject to change without notice. Users should warrant and guarantee that third party Intellectual Property rights are not infringed upon when integrating MPS products into any application. MPS will not assume any legal responsibility for any said applications.