



Obsolescence Notice

This product is obsolete.

This information is available for your convenience only.

For more information on Zarlink's obsolete products and replacement product lists, please visit http://products.zarlink.com/obsolete_products/

SL541

HIGH SLEW RATE OPERATIONAL AMPLIFIER

The SL541 is a monolithic amplifier designed for optimum pulse response and applications requiring high slew rate with fast setting time to high accuracy. The high open loop gain is stable with temperature, allowing the desired closed loop gain to be achieved using standard operational amplifier techniques. The device has been designed for optimum response at a gain of 20dB when no compensation is required. The SL541B has a guaranteed input offset voltage of $\pm 5\text{mV}$ maximum and replaces the SL541C.

FEATURES

- High Slew Rate 175V/ μs
- Fast Setting Time 1% in 50ns
- Open Loop Gain 70dB (SL541B)
- Wide Bandwidth DC to 100MHz at 10dB Gain
- Very Low Thermal Drift 0.02dB/ $^{\circ}\text{C}$ Temperature Coefficient of Gain
- Guaranteed 5mV input offset maximum

APPLICATIONS

- Wideband IF Amplification
- Wideband Video Amplification
- Fast setting Pulse Amplifiers
- High Speed Integrators
- D/A and A/D Conversion
- Fast Multiplier Preamps

ABSOLUTE MAXIMUM RATINGS

Supply voltage (V_+ to V_-)	24V
Input voltage (Inv. I/P to non inv. I/P)	$\pm 9\text{V}$
Storage temperature -55°C to $+150^{\circ}\text{C}$	
Chip operating temperature	$+150^{\circ}\text{C}$
Thermal resistances	
Chip to ambient TO-5	220 $^{\circ}\text{C}/\text{W}$
DIL	125 $^{\circ}\text{C}/\text{W}$
Chip to case TO-5	65 $^{\circ}\text{C}/\text{W}$
DIL	40 $^{\circ}\text{C}/\text{W}$

ORDERING INFORMATION

SL541 B CM
SL541 B DG
SL541 NA IC (NAKED DIE)

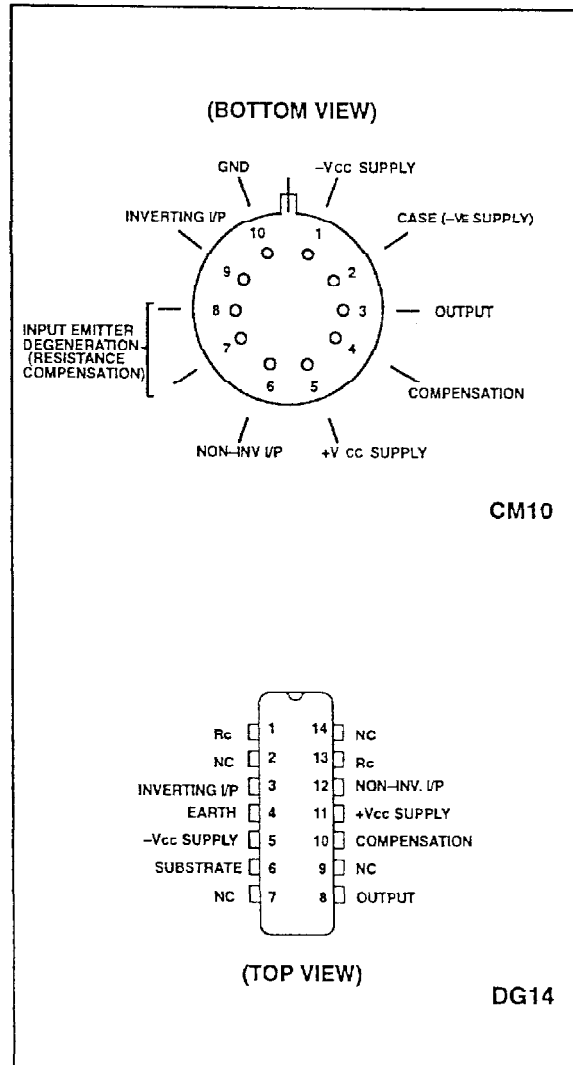

Fig. 1 pin connections

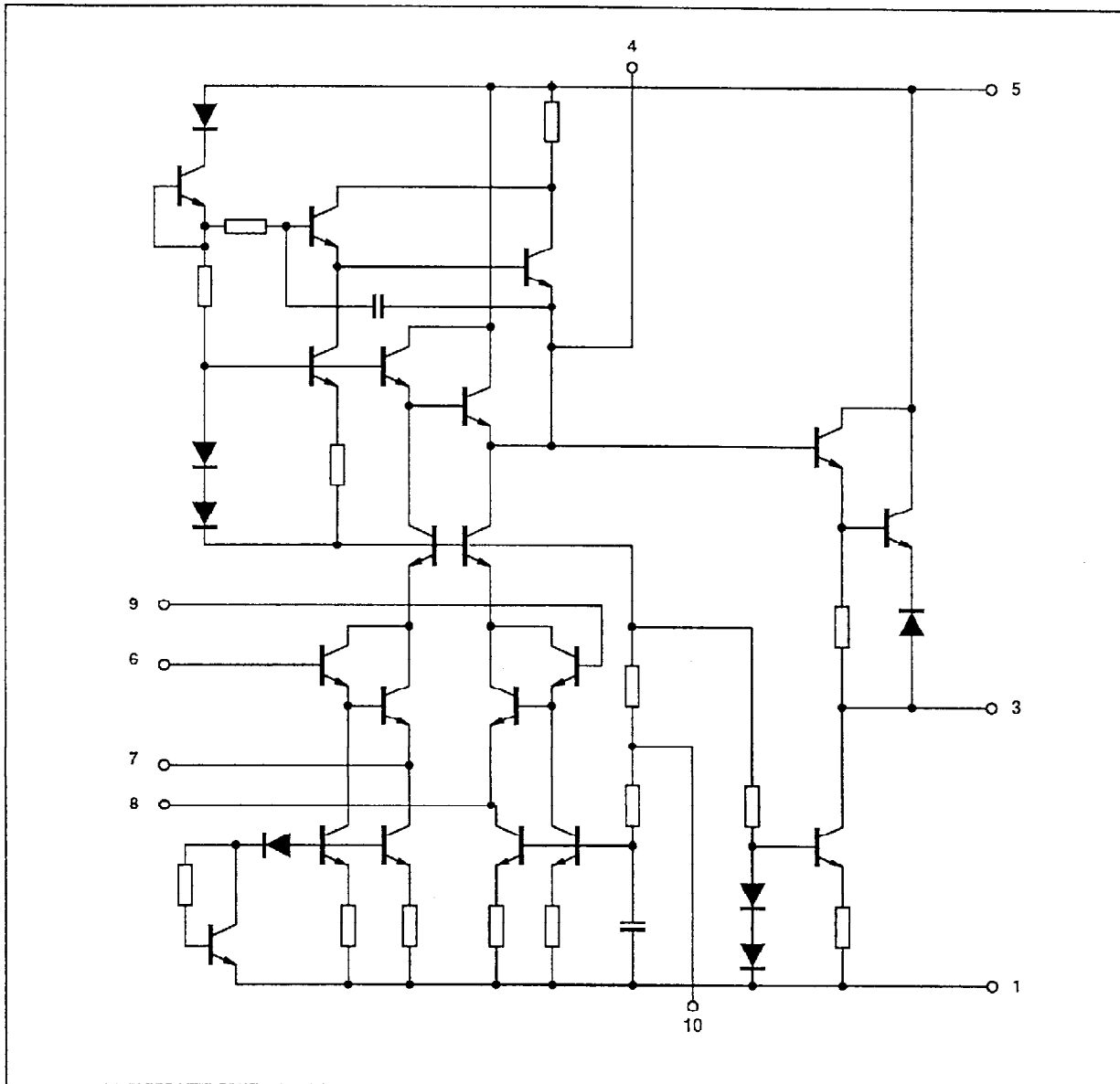

Fig. 2 SL541 circuit diagram (TO-5 pin nos)

ELECTRICAL CHARACTERISTICS

$T_{amb} = 22^{\circ}\text{C} \pm 2^{\circ}\text{C}$, $R_c = 0\Omega$. These characteristics are guaranteed over the following conditions. They apply within the specified ambient temperature and supply voltage ranges unless otherwise stated.

Characteristics	Circuit	Value			Units	Conditions
		Min	Typ	Max		
Static nominal supply current	A, B		16	21	mA	
Input bias current	A, B		7	25	μA	
Input offset voltage	B			5	mV	
Input offset voltage	A			10	mV	
Dynamic open loop gain	A	45	54		dB	600 Ω load
	B	60	71		dB	
Open loop temperature coefficient	A, B		-0.02		dB/ $^{\circ}\text{C}$	
Closed loop bandwidth (-3dB)	A, B		100		MHz	X10 gain
Slew rate (4V peak)	A, B	100	175		V/ μs	X10 gain
Setting time to 1%	A, B		50	100	ns	
Maximum output voltage						
(+ve)	A	5.5	5.7		V	
(-ve)	A		-1.9	-1.5	V	
(+ve)	B	2.5	3.0		V	
(-ve)	B		-3.0	-2.5	V	
Maximum output current	A, B	4	6.5		mA	
Maximum input voltage						
(+ve)	A			5	V	Non-inverting Modes
(-ve)	A	-1			V	
(+ve)	B			3	V	
(-ve)	B	-3			V	
Supply line rejection						
(+ve)	A, B	54	66		dB	
(-ve)	A, B	46	54		dB	
Input offset current	A, B			9.85	μA	
Common mode rejection	A, B	60.7			dB	
Input offset voltage drift	A		25		$\mu\text{V}/^{\circ}\text{C}$	

ELECTRICAL CHARACTERISTICS (Typical)

$T_{amb} = -40^{\circ}\text{C}$ to 85°C , $R_c = 0\Omega$. Test circuit B These characteristics are guaranteed over the following conditions. They apply within the specified ambient temperature and supply voltage ranges unless otherwise stated.

Characteristics	Value			Units	Conditions
	Min	Typ	Max		
Static nominal supply current		16	25	mA	Non-inverting modes
Input bias current			35	μA	
Input offset voltage (+ve)			8	mV	
Input offset voltage (-ve)	-8			mV	
Maximum output current	3.5	6.5		mA	
Maximum input voltage (+ve)			3	V	
Maximum input voltage (-ve)	-3			V	
Supply line rejection (+ve)	50			dB	
Supply line rejection (-ve)	42			dB	
Maximum output voltage (+ve)	2.3			V	
Maximum output voltage (-ve)			2.5	V	
Common mode rejection	55			dB	
Input offset current			16	μA	
Output voltage drift		15		$\mu\text{V}/^{\circ}\text{C}$	
Input bias current drift		60		$\text{nA}/^{\circ}\text{C}$	
Output current drift		40		$\text{nA}/^{\circ}\text{C}$	

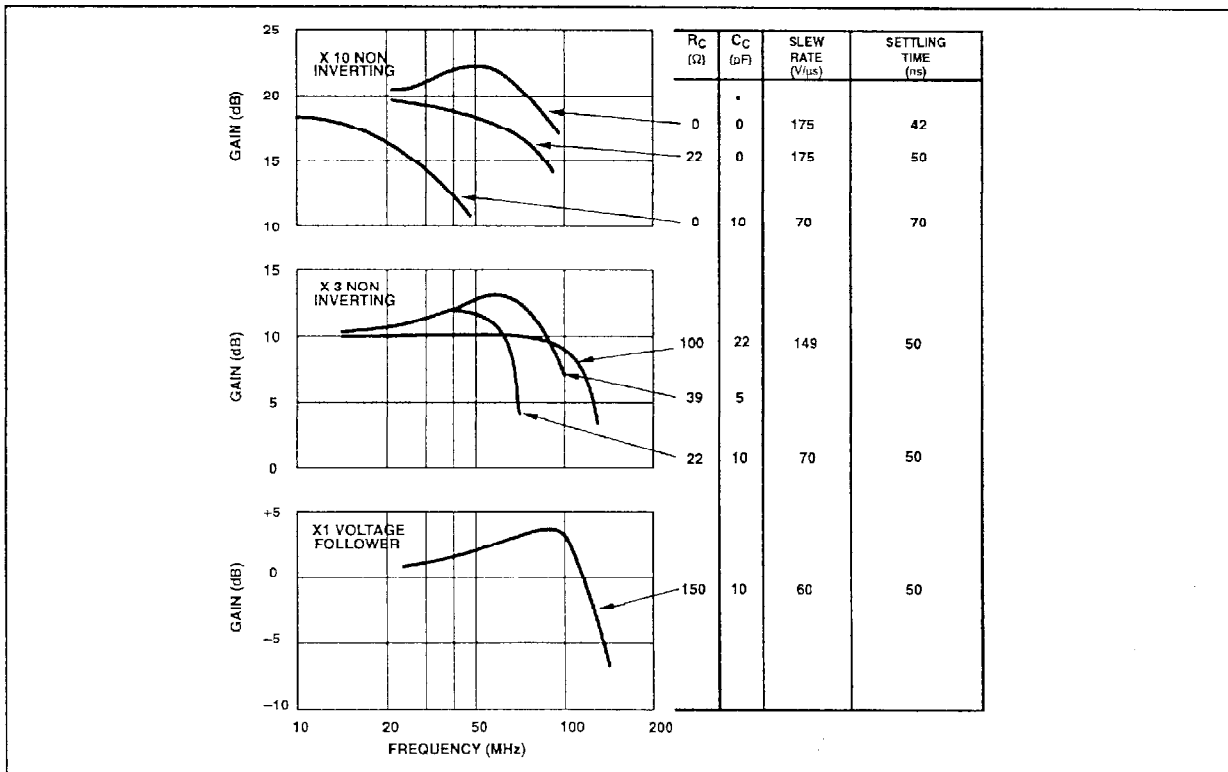

Fig. 3 Performance graphs – gain v. frequency (load=2kΩ/10pF) *See operating note 2

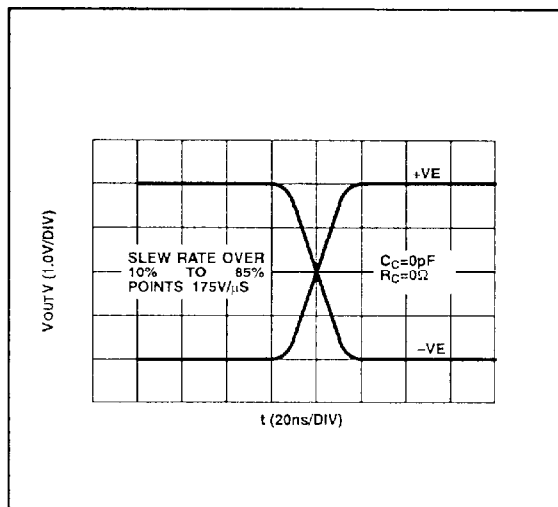

Fig. 4. Slew rate –X10 non inverting mode input square wave 0.4V p/p

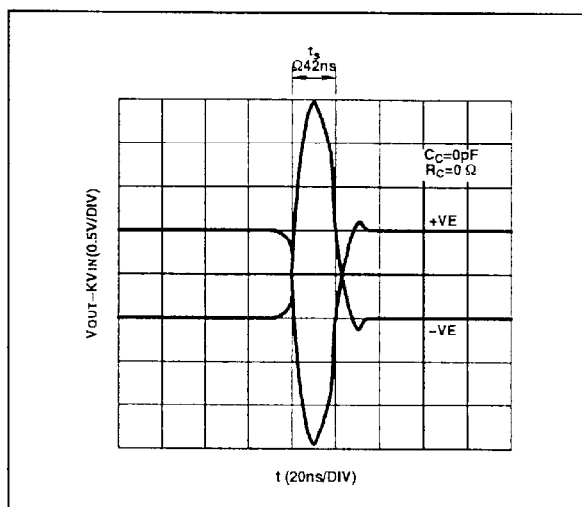

Fig.5 Settling time – X10 non-inverting mode

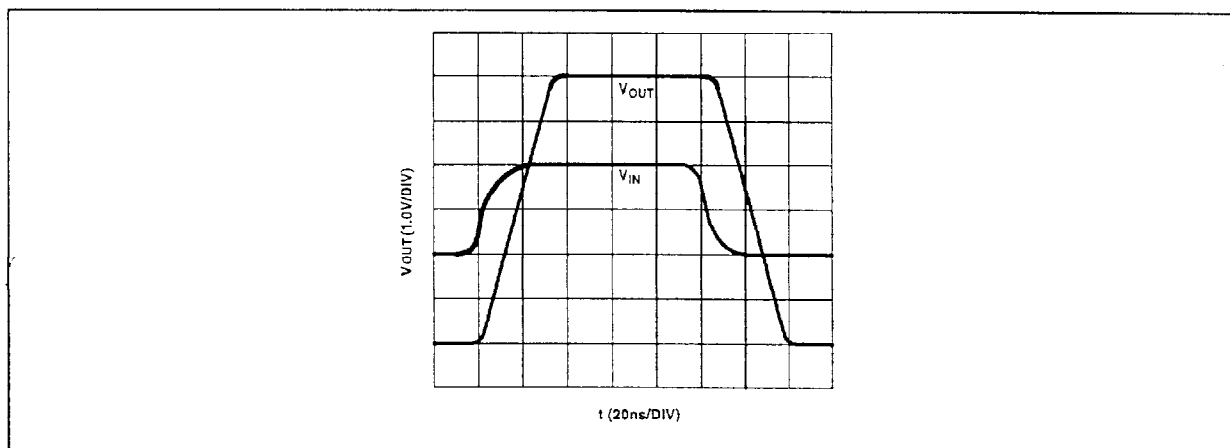

Fig.6 Output clipping levels – X10 non – inverting mode input moderately overdriven, so that output goes into clipping both sides.

OPERATING NOTES

The SL541 may be used as a normal, but non saturating operational amplifier, in any of the usual configurations (amplifiers, integrators etc.), provided that the following points are observed:

1. Positive supply line decoupling back to the output load earth should always be provided close to the device terminals.
2. Compensation capacitors should be connected between pins 4 and 5. These may have any value greater than that necessary for stability without causing side offsets.
3. The circuit is generally intended to be fed from a fairly low impedance ($<1\text{k}\Omega$), as seen from pins 6 and 9– 100Ω or less

results in optimum speed.

4. The circuit is designed to withstand a certain degree of capacitive loading (up to 20pF) with virtually no effect. However, very high capacitive loads will cause loss of speed due to the extra compensation required and asymmetric output slew rates.

5. Pin 10 does not need to be connected to zero volts except where the clipping levels need to be defined accurately w.r.t. zero. If disconnected, an extra ± 0.5 volt uncertainty in the clipping levels results, but the separation remains. However, the supply line rejection is improved if pin 10 can be left open-circuit (circuit B only).

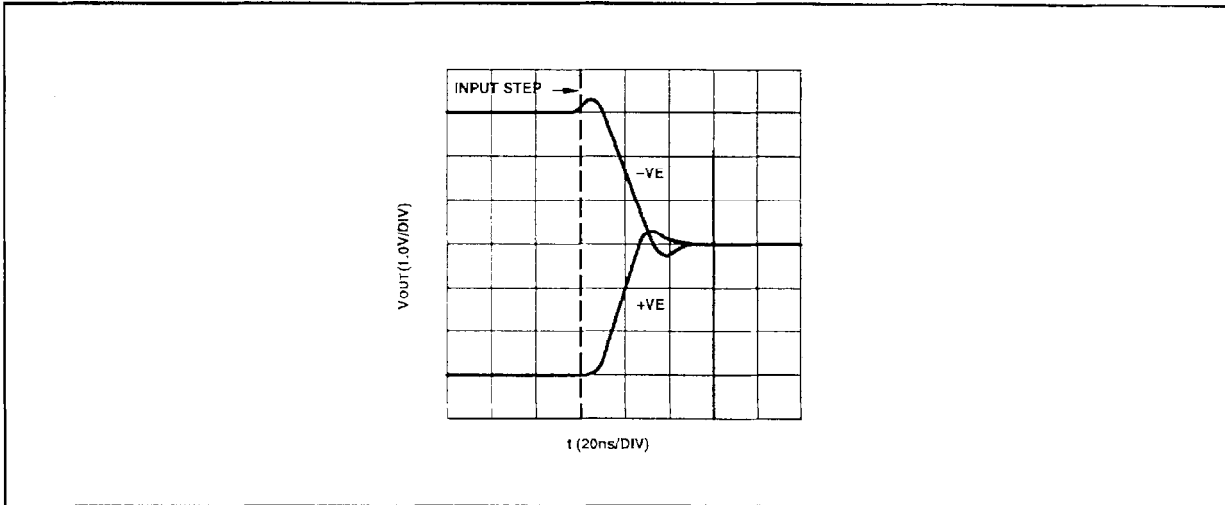

Fig. 7 Output clippings level – X10 non-inverting mode. Output goes from clipping to zero volts. $V_{IN}=3V$ peak step, offset +ve or -ve.

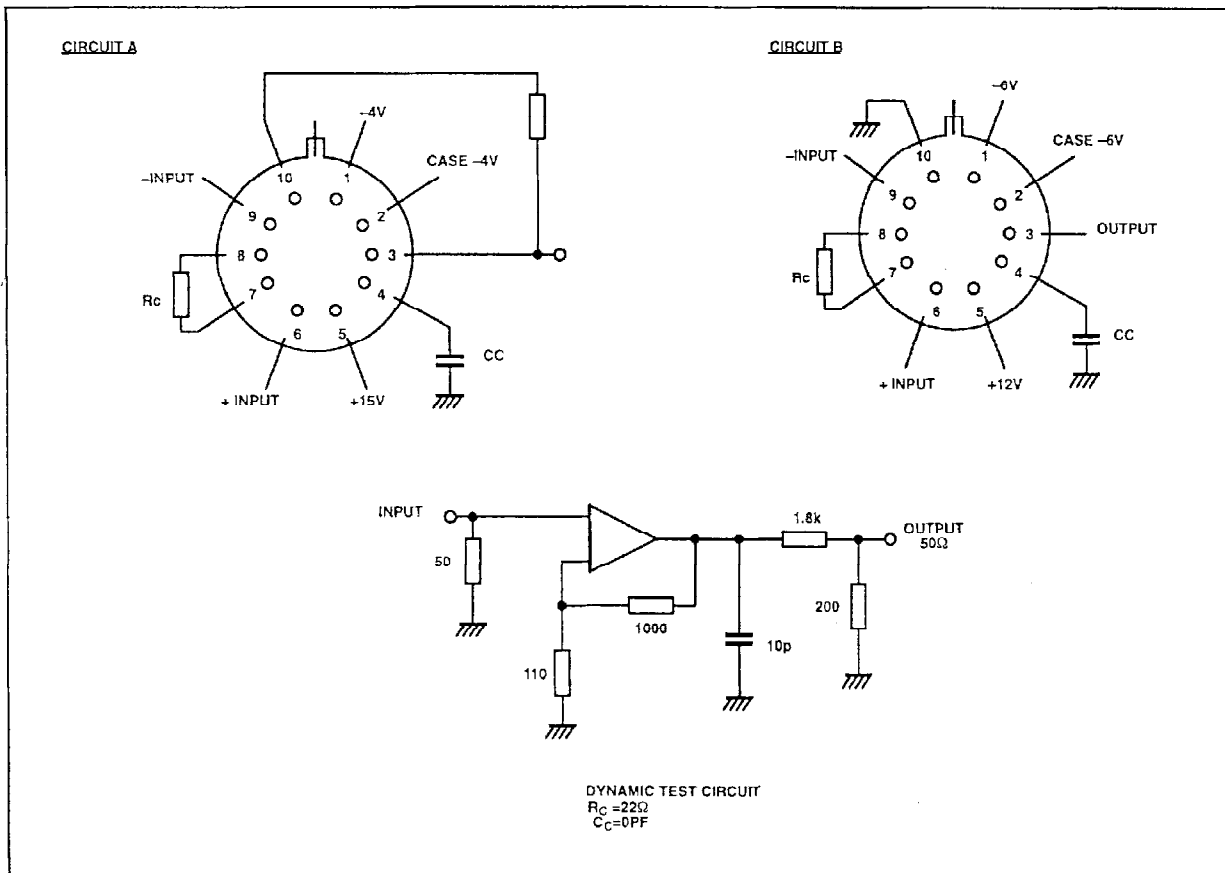

Fig. 8 Test circuit

TEST CONDITIONS AND DEFINITIONS

Both slew rate and settling time are measures of an amplifier's speed of response to an input. Slew rate is an inherent characteristic of the amplifier and is generally less subject to misinterpretation than is settling time, which is often more dependant upon the test circuit than the amplifier's ability to perform.

Slew rate defines the maximum rate of change of output voltage for a large step input change and is related to the full power frequency response (fp) by the relationship.

$$S = 2\pi f_p E_o$$

where E_o is the peak output voltage

Settling time is defined as the time elapsed from the application of a fast input step to the time when the amplifier output has entered and remained within a specified error band that is symmetrical about the final value. Settling time, therefore, is comprised of an initial propagation delay, an additional time for the amplifier to slew to the vicinity of some value of the output voltage, plus a period to recover from overload and settle within the given error band.

The SL541 is tested for slew rate in a X10 gain configuration.

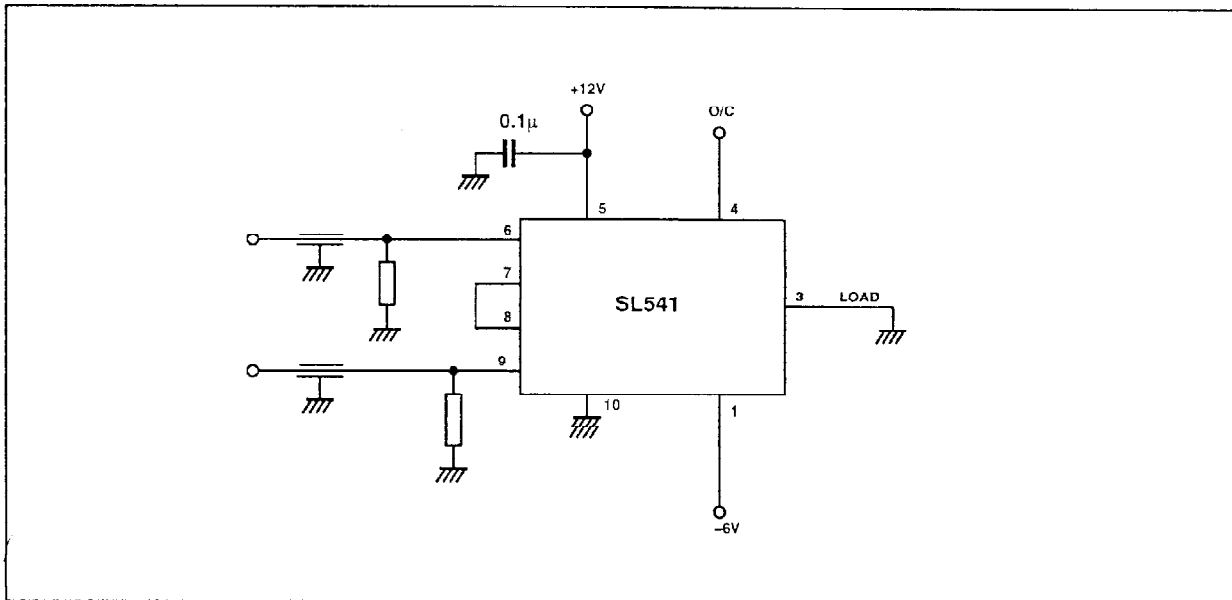

Fig. 9 Non saturating sense amplifier (30V/µs for 5mV).
Note: the output may be caught at a pre determined level. (T0-5 pin nos.)

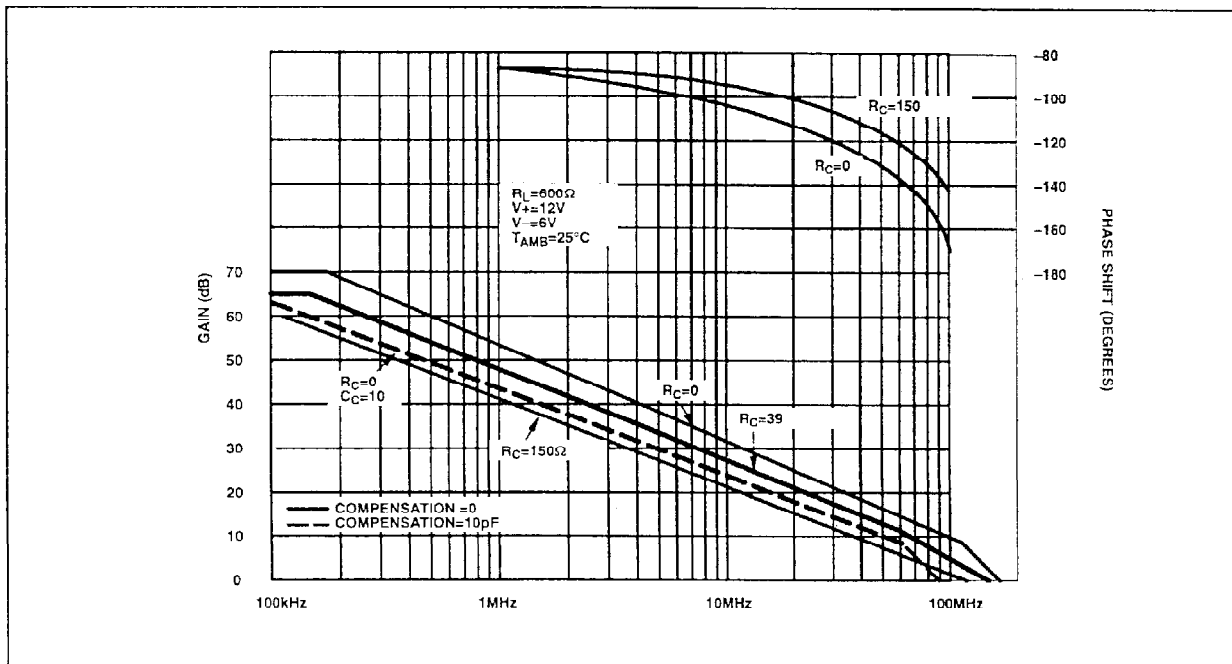
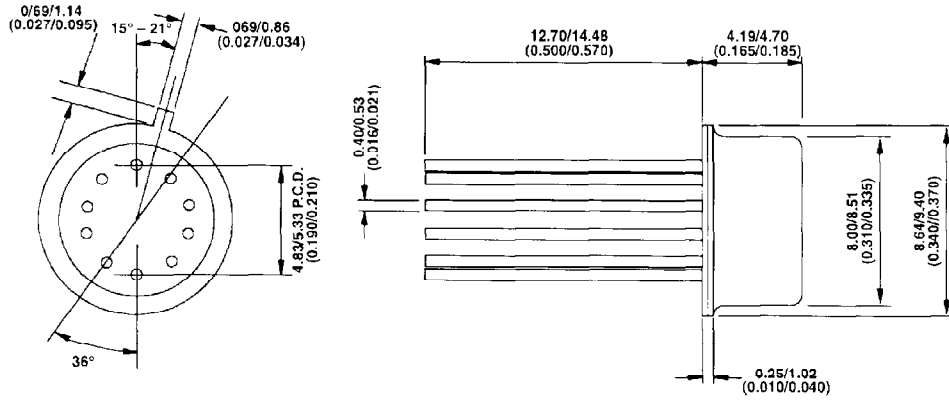

Fig. 10 SL541B open loop gain and phase shift v. frequency

SL541

PACKAGE DETAILS

Dimensions are shown thus: mm (in). For further package information please contact your local Customer Service Centre.



10-LEAD METAL CAN - CM10

14-LEAD CERAMIC
DIL-DG14

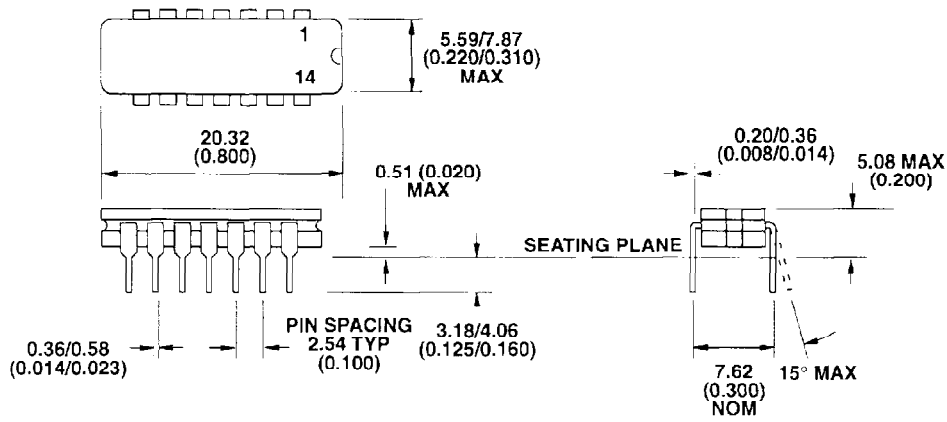



HEADQUARTERS OPERATIONS

GEC PLESSEY SEMICONDUCTORS
Cheney Manor, Swindon,
Wiltshire United Kingdom SN2 2QW.
Tel: (0793) 518000
Fax: (0793) 518411

GEC PLESSEY SEMICONDUCTORS
P.O. Box 660017 1500 Green Hills Road,
Scotts Valley, California 95067-0017,
United States of America. Tel: (408) 438 2900
Fax: (408) 438 5576

CUSTOMER SERVICE CENTRES

- **FRANCE & BENELUX** Les Ulis Cedex Tel: (1) 64 46 23 45
Fax: (1) 64 46 06 07
 - **GERMANY** Munich Tel: (089) 3609 06 0 Fax: (089) 3609 06 55
 - **ITALY** Milan Tel: (02) 66040867 Fax: (02) 66040993
 - **JAPAN** Tokyo Tel: (03) 5276-5501 Fax: (03) 5276-5510
 - **NORTH AMERICA** Scotts Valley, USA
Tel: (408) 438 2900 Fax: (408) 438 7023
 - **SOUTH EAST ASIA** Singapore Tel: (65) 3827708 Fax: (65) 3828872
 - **SWEDEN** Stockholm Tel: 46 8 7029770 Fax: 46 8 6404736
 - **UK, EIRE, DENMARK, FINLAND & NORWAY**
Swindon Tel: (0793) 518510 Fax: (0793) 518582
- These are supported by Agents and Distributors in major countries world-wide.

© GEC Plessey Semiconductors 1994 Publication No. D.S. 3619 Issue No. 1.4 April 1994

This publication is issued to provide information only, which (unless agreed by the Company in writing) may not be used, applied or reproduced for any purpose nor form part of any order or contract nor to be regarded as a representation relating to the products or services concerned. No warranty or guarantee express or implied is made regarding the capability, performance or suitability of any product or service. The Company reserves the right to alter without prior knowledge the specification, design, or price of any product or service. Information concerning possible methods of use is provided as a guide only and does not constitute any guarantee that such methods of use will be satisfactory in a specific piece of equipment. It is the user's responsibility to fully determine the performance and suitability of any equipment using such information and to ensure that any publication or data used is up to date and has not been superseded. These products are not suitable for use in any medical products whose failure to perform may result in significant injury or death to the user. All products and materials are sold and services provided subject to the Company's conditions of sale, which are available on request.