

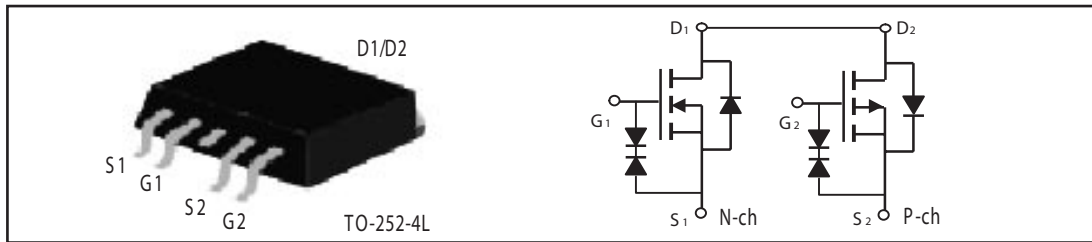

Dual Enhancement Mode Field Effect Transistor (N and P Channel)

PRODUCT SUMMARY (N-Channel)		
V _{DSS}	I _D	R _{DS(ON)} (m Ω) Max
30V	19A	20 @ V _{GS} = 10V
		28 @ V _{GS} = 4.5V

PRODUCT SUMMARY (P-Channel)		
V _{DSS}	I _D	R _{DS(ON)} (m Ω) Max
-30V	-15A	30 @ V _{GS} = -10V
		44 @ V _{GS} = -4.5V



ABSOLUTE MAXIMUM RATINGS (T_A=25°C unless otherwise noted)

Parameter		Symbol	N-Channel	P-Channel	Unit
Drain-Source Voltage		V _{DS}	30	-30	V
Gate-Source Voltage		V _{GS}	±20	±20	V
Drain Current-Continuous @ T _c	25°C	I _D	19	-15	A
	70°C		17	-13	A
-Pulsed ^a		I _{DM}	50	-50	A
Drain-Source Diode Forward Current		I _S	10	-6	A
Maximum Power Dissipation	T _c = 25°C	P _D	11		W
	T _c = 70°C		7.7		
Operating Junction and Storage Temperature Range		T _J , T _{STG}	-55 to 175		°C

THERMAL CHARACTERISTICS

Thermal Resistance, Junction-to-Case	R θ JC	13.6	°C/W
Thermal Resistance, Junction-to-Ambient	R θ JA	120	°C/W

STU310DH

N-Channel ELECTRICAL CHARACTERISTICS (TA = 25 °C unless otherwise noted)

Parameter	Symbol	Condition	Min	Typ ^c	Max	Unit
OFF CHARACTERISTICS						
Drain-Source Breakdown Voltage	BV _{DSS}	V _{GS} =0V, I _D =250uA	30			V
Zero Gate Voltage Drain Current	I _{DSS}	V _{DS} =24V, V _{GS} =0V			1	uA
Gate-Body Leakage	I _{GSS}	V _{GS} =±20V, V _{DS} =0V			±10	uA
ON CHARACTERISTICS ^a						
Gate Threshold Voltage	V _{GS(th)}	V _{DS} =V _{GS} , I _D =250uA	1	1.8	3	V
Drain-Source On-State Resistance	R _{DS(ON)}	V _{GS} =10V, I _D =10A		14	20	m ohm
		V _{GS} =4.5V, I _D =8A		20	28	m ohm
On-State Drain Current	I _{D(ON)}	V _{DS} =5V, V _{GS} =4.5V	20			A
Forward Transconductance	g _{FS}	V _{DS} =10V, I _D =10A		16.5		S
DYNAMIC CHARACTERISTICS ^b						
Input Capacitance	C _{ISS}	V _{DS} =15V, V _{GS} =0V f=1.0MHz		635		pF
Output Capacitance	C _{OSS}			170		pF
Reverse Transfer Capacitance	C _{RSS}			97		pF
SWITCHING CHARACTERISTICS ^b						
Turn-On Delay Time	t _{D(ON)}	V _{DD} =15V I _D =1A V _{GS} =10V R _{GEN} =6 ohm		12.5		ns
Rise Time	t _r			12		ns
Turn-Off Delay Time	t _{D(OFF)}			45		ns
Fall Time	t _f			10		ns
Total Gate Charge	Q _g	V _{DS} =15V, I _D =20A, V _{GS} =10V		12		nC
		V _{DS} =15V, I _D =20A, V _{GS} =4.5V		6		nC
Gate-Source Charge	Q _{gs}	V _{DS} =15V, I _D =20A V _{GS} =10V		1.8		nC
Gate-Drain Charge	Q _{gd}			3.5		nC

STU310DH

P-Channel ELECTRICAL CHARACTERISTICS (T_A = 25 °C unless otherwise noted)

Parameter	Symbol	Condition	Min	Typ ^c	Max	Unit
OFF CHARACTERISTICS						
Drain-Source Breakdown Voltage	BV _{DSS}	V _{GS} =0V, I _D =-250uA	-30			V
Zero Gate Voltage Drain Current	I _{DSS}	V _{DS} =-24V, V _{GS} =0V			-1	uA
Gate-Body Leakage	I _{GSS}	V _{GS} =±20V, V _{DS} =0V			±10	uA
ON CHARACTERISTICS^a						
Gate Threshold Voltage	V _{GS(th)}	V _{DS} =V _{GS} , I _D =-250uA	-1	-1.8	-3	V
Drain-Source On-State Resistance	R _{DS(ON)}	V _{GS} =-10V, I _D =-6A		24	30	m ohm
		V _{GS} =-4.5V, I _D =-4A		35	44	m ohm
On-State Drain Current	I _{D(ON)}	V _{DS} =-5V, V _{GS} =-10V	-20			A
Forward Transconductance	g _{FS}	V _{DS} =-10V, I _D =-6A		12.5		S
DYNAMIC CHARACTERISTICS^b						
Input Capacitance	C _{ISS}	V _{DS} =-15V, V _{GS} =0V f=1.0MHz		1120		pF
Output Capacitance	C _{OSS}			280		pF
Reverse Transfer Capacitance	C _{RSS}			190		pF
SWITCHING CHARACTERISTICS^b						
Turn-On Delay Time	t _{D(ON)}	V _{DD} =-15V I _D =-1A V _{GS} =-10V R _{GEN} =6 ohm		15		ns
Rise Time	t _r			28		ns
Turn-Off Delay Time	t _{D(OFF)}			110		ns
Fall Time	t _f			30		ns
Total Gate Charge	Q _g	V _{DS} =-15V, I _D =-20A, V _{GS} =-10V		22		nC
		V _{DS} =-15V, I _D =-20A, V _{GS} =-4.5V		10.5		nC
Gate-Source Charge	Q _{gs}	V _{DS} =-15V, I _D =-20 A		2.5		nC
Gate-Drain Charge	Q _{gd}	V _{GS} =-10V		6.5		nC

STU310DH

ELECTRICAL CHARACTERISTICS ($T_A=25^\circ\text{C}$ unless otherwise noted)

Parameter	Symbol	Condition	Min	Typ ^c	Max	Unit	
DRAIN-SOURCE DIODE CHARACTERISTICS^b							
Diode Forward Voltage	V_{SD}	$V_{GS} = 0V, I_S = 10A$	N-Ch		0.9	1.3	V
		$V_{GS} = 0V, I_S = -6A$	P-Ch		-0.9	-1.3	

Notes

a. Pulse Test: Pulse Width $\leq 300 \mu s$, Duty Cycle $\leq 2\%$.

b. Guaranteed by design, not subject to production testing.

N-Channel

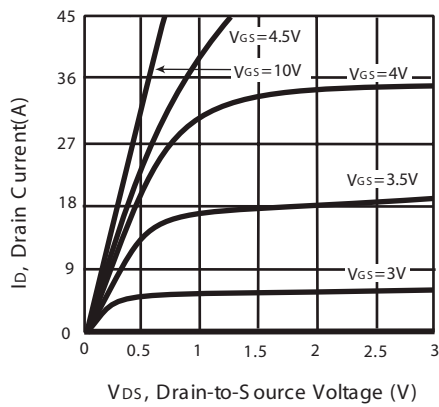

Figure 1. Output Characteristics

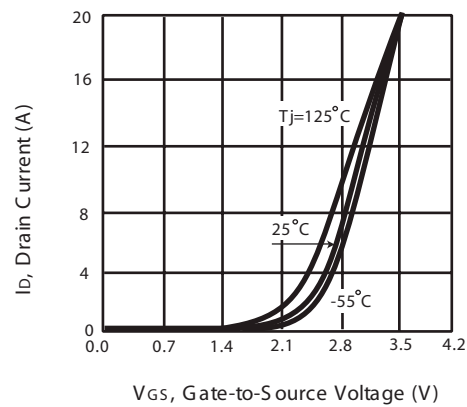

Figure 2. Transfer Characteristics

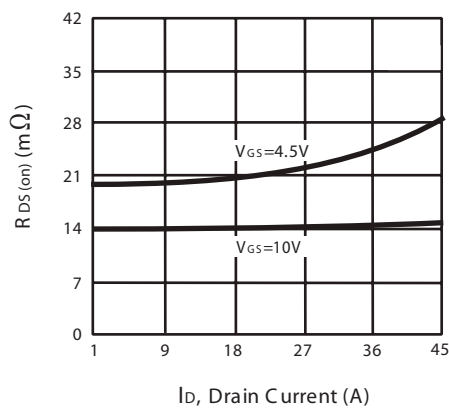

Figure 3. On-Resistance vs. Drain Current and Gate Voltage

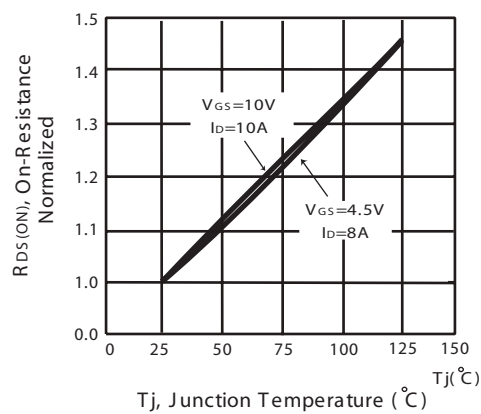

Figure 4. On-Resistance Variation with Drain Current and Temperature

STU310DH

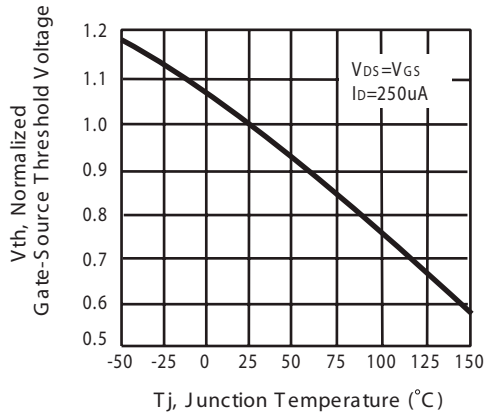

Figure 5. Gate Threshold Variation with Temperature

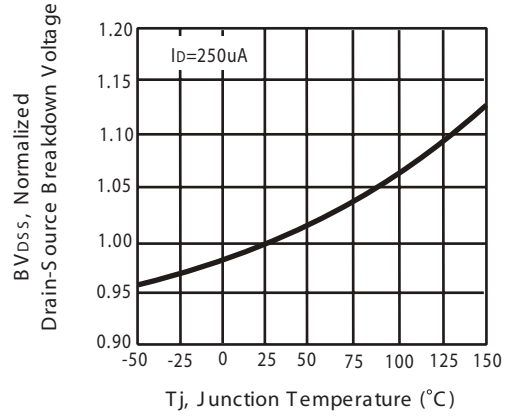

Figure 6. Breakdown Voltage Variation with Temperature

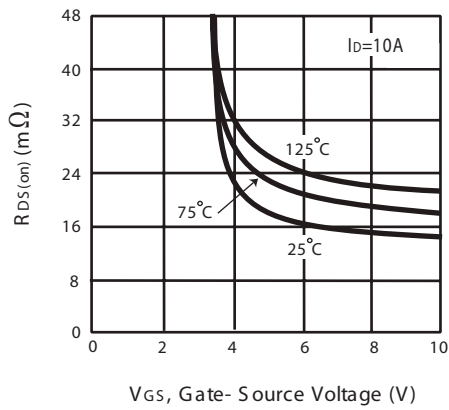

Figure 7. On-Resistance vs. Gate-Source Voltage

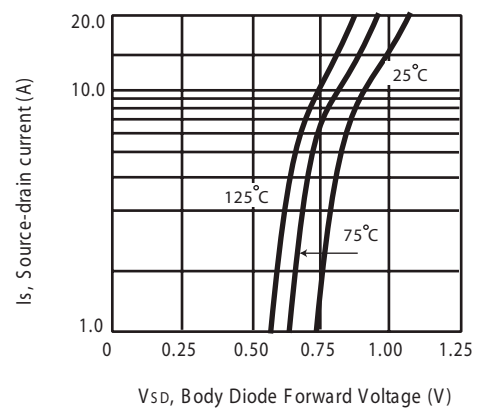

Figure 8. Body Diode Forward Voltage Variation with Source Current

STU310DH

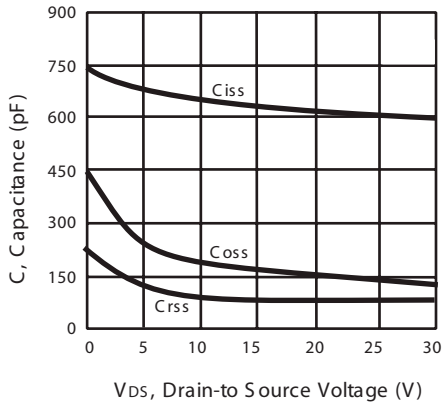

Figure 10. Capacitance

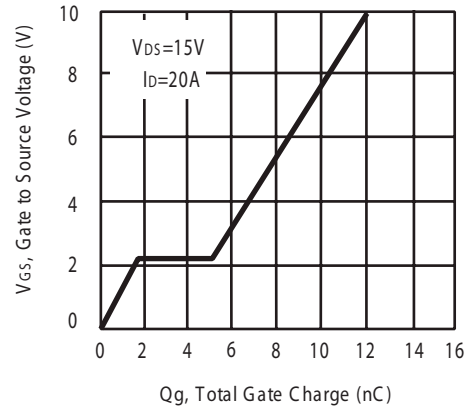

Figure 11. Gate Charge

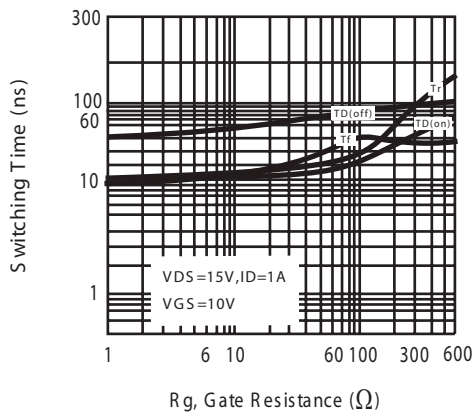

Figure 12. switching characteristics

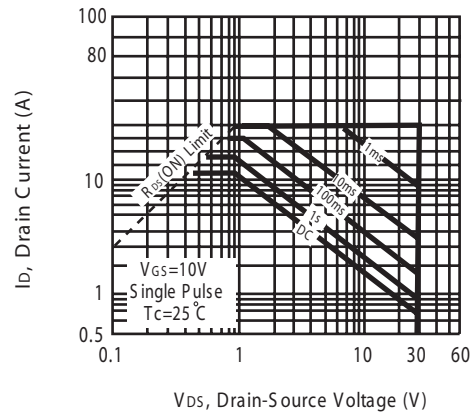

Figure 13. Maximum Safe Operating Area

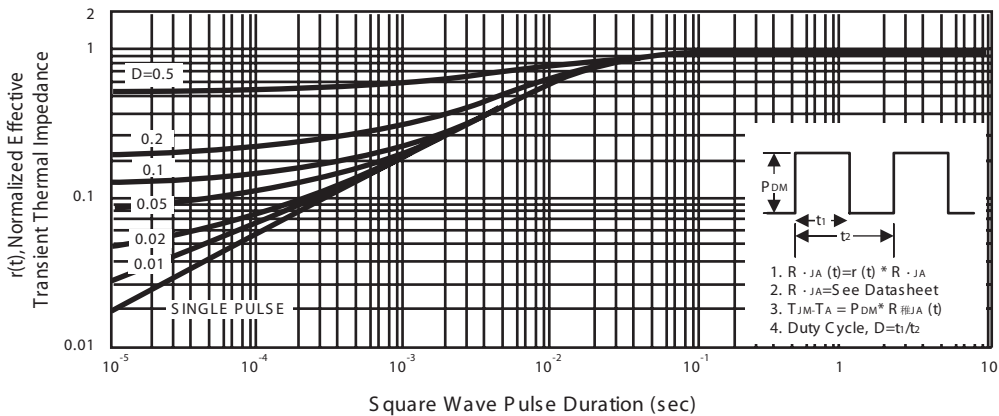

Figure 14. Normalized Thermal Transient Impedance Curve

STU310DH

P-Channel

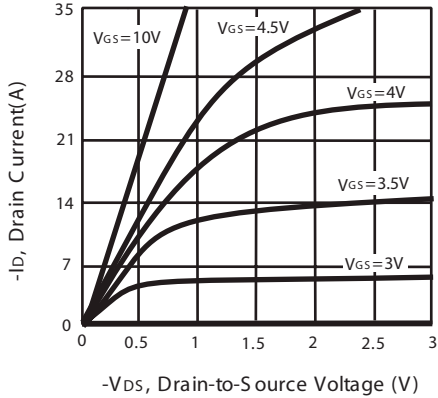

Figure 1. Output Characteristics

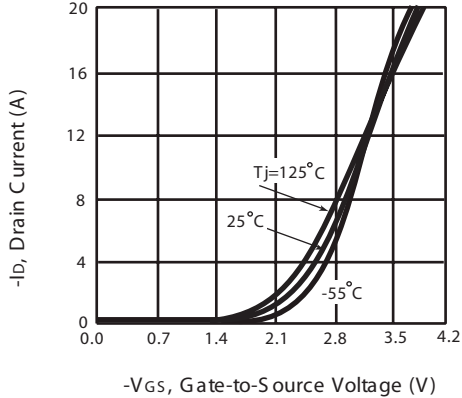

Figure 2. Transfer Characteristics

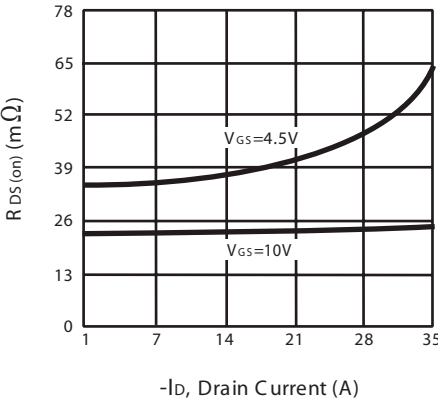

Figure 3. On-Resistance vs. Drain Current and Gate Voltage

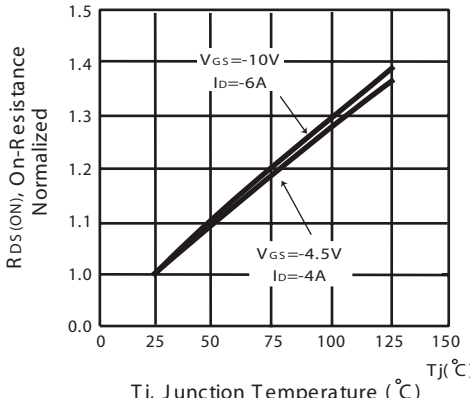

Figure 4. On-Resistance Variation with Drain Current and Temperature

STU310DH

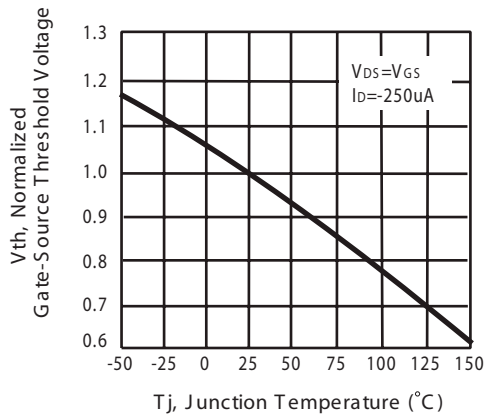

Figure 5. Gate Threshold Variation with Temperature

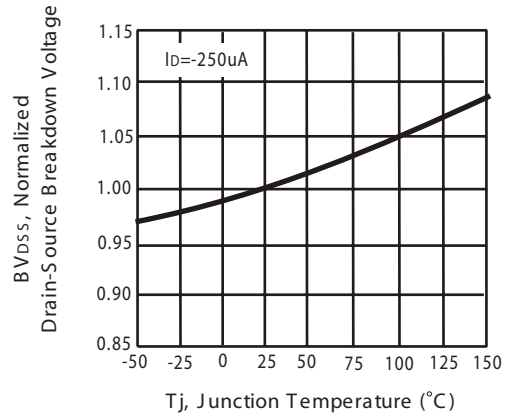

Figure 6. Breakdown Voltage Variation with Temperature

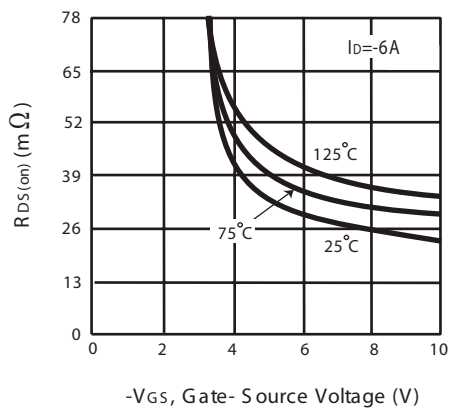

Figure 7. On-Resistance vs. Gate-Source Voltage

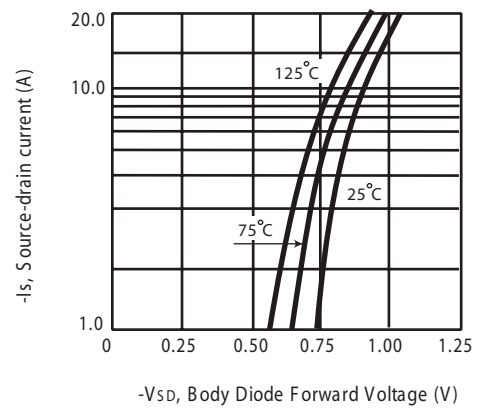

Figure 8. Body Diode Forward Voltage Variation with Source Current

STU310DH

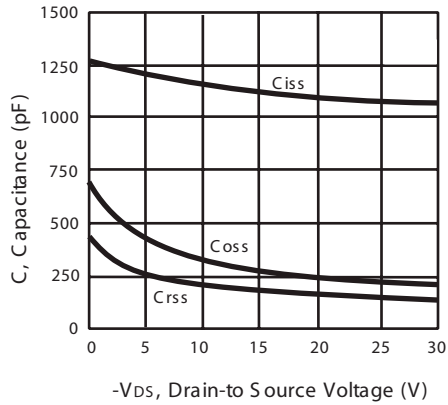

Figure 10. Capacitance

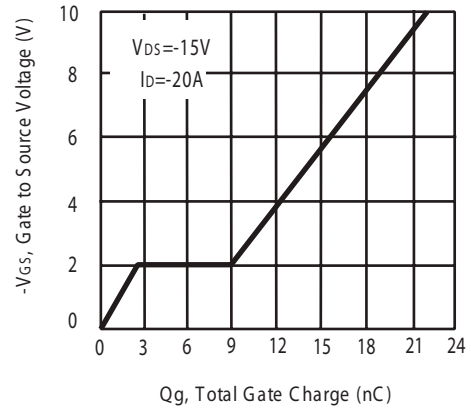

Figure 11. Gate Charge

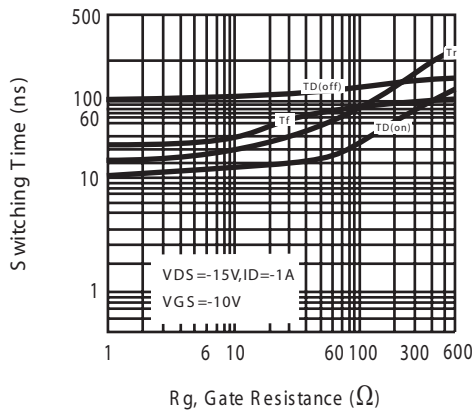

Figure 12. switching characteristics

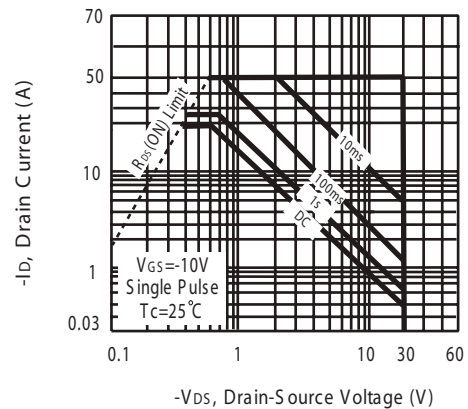

Figure 13. Maximum Safe Operating Area

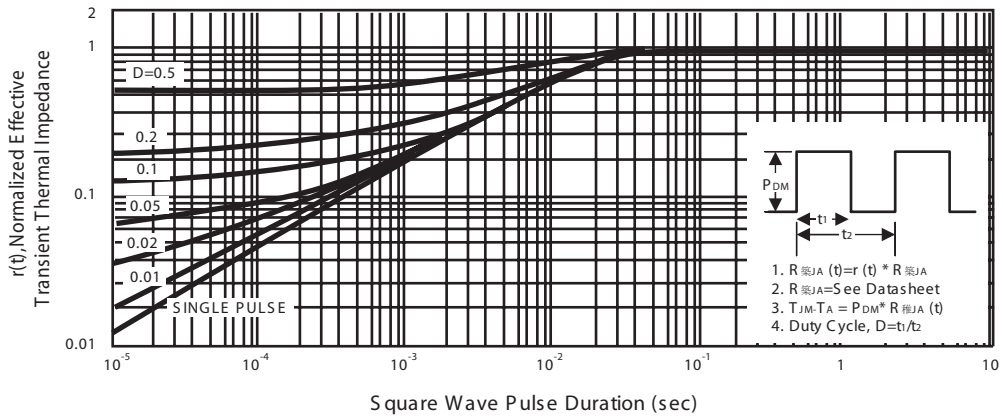
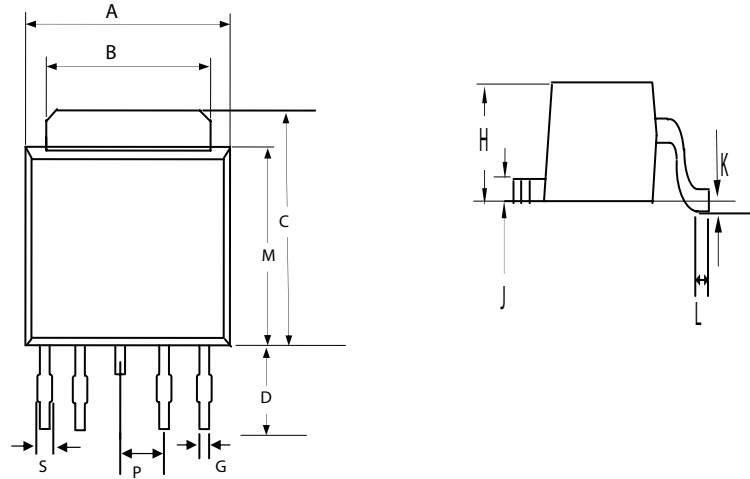

Figure 14. Normalized Thermal Transient Impedance Curve

STU310DH

PACKAGE OUTLINE DIMENSIONS

TO-252-4L



REF .	Millimeters	
	MIN	MAX
A	6.40	6.80
B	5.2	5.50
C	6.80	10.20
D	2.20	3.00
P	1.27 REF .	
S	0.50	0.80
G	0.40	0.60
H	2.20	2.40
J	0.45	0.60
K	0	0.15
L	0.90	1.50
M	5.40	5.80

STU310DH

TO-252-4L Tape and Reel Data

TO-252-4L Carrier Tape

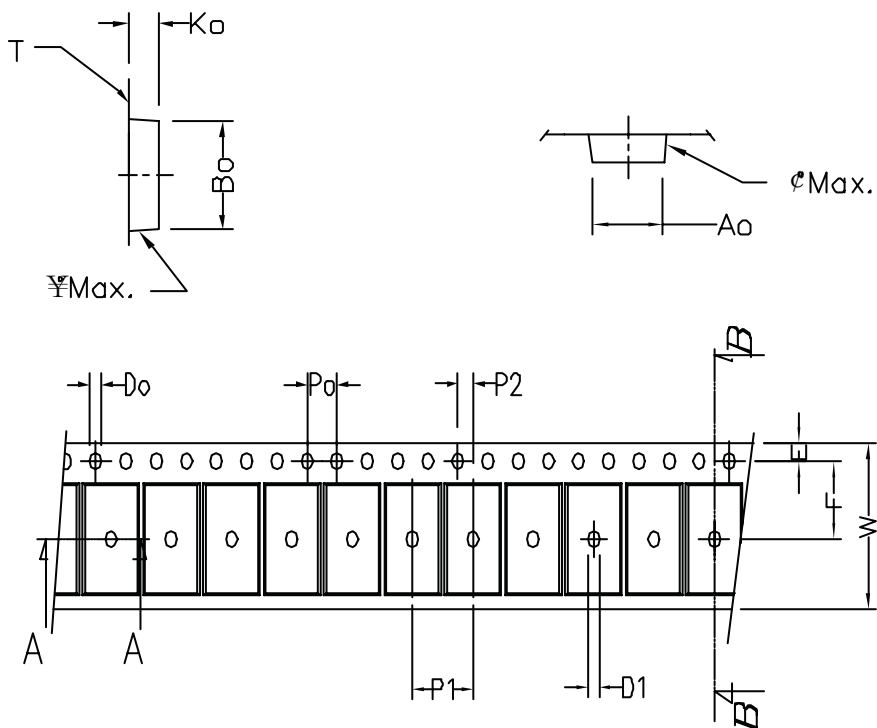

symbol	Ao	Bo	Ko	Po	P1	P2	T
Spec	6.96±0.1	10.49±0.1	2.79±0.1	4.0±0.1	8.0±0.10	2.0±0.05	0.33±0.013
symbol	E	F	Do	D1	W	10Po	
Spec	1.75±0.1	7.5±0.05	1.55±0.05	1.5±0.25	16.0 ^{+0.3} _{-0.1}	40.0±0.2	

TO-252-4L Reel

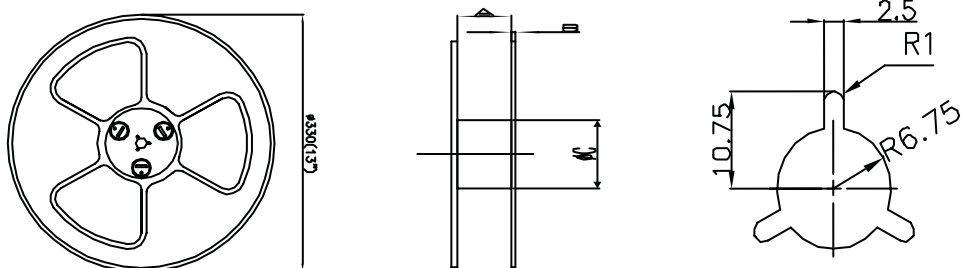

UNIT: mm

Width of carrier tape	8	12	16	24	32	44	56
A±0.1	9.4	13.4	17.4	25.4	33.4	45.4	57.4
B	2.3	2.3	2.3	2.3	2.3	2.3	2.3
∅C	100	100	100	100	100	100	100