



UVTOP260-HL-TO39

- Deep Ultraviolet Light Emission Source
- 265 nm, 0.6 mW
- TO39 Package
- Hemispherical Sapphire Lens
-  Forensic Analysis, Disinfection



Description

UVTOP260-HL-TO39 is a deep ultraviolet light emission source, based on **AlGaN** quantum structures, typically emitting at **265 nm** with an optical output power of **0.6 mW**. It comes in hermetically sealed TO39 metal can package with a hemispherical sapphire lens, is Lead-free, and RoHS compliant. **UVTOP260-HL-TO39** is widely used for forensic analysis, disinfection, optical sensing, and imaging applications.

Maximum Rating ($T_{CASE} = 25^{\circ}C$)

Parameter	Symbol	Values		Unit
		Min.	Max.	
Power Dissipation, DC	P_D		180	mW
Forward Current*	I_F		30	mA
Operating Temperature*	T_{OPR}	- 30	+ 55	$^{\circ}C$
Storage Temperature	T_{STG}	- 30	+ 100	$^{\circ}C$
Soldering Temperature	T_{SOL}		+ 190	$^{\circ}C$

* Operation close to the absolute maximum ratings may affect device reliability

Electro-Optical Characteristics ($T_{CASE} = 25^{\circ}C$, $I_F = 20$ mA)

Parameter	Symbol	Values			Unit
		Min.	Typ.	Max.	
Peak Wavelength ^{*1}	λ_P	260		270	nm
Spectral Width (FWHM)	$\Delta\lambda$		11	15	nm
Forward Voltage ^{*2}	V_F		6.0	7.0	V
Radiated Power ^{*3}	P_O	0.4	0.6		mW
Beam Angle	$2\theta_{1/2}$		7		deg.
Thermal Resistance	R_{th}		50		$^{\circ}C/W$

^{*1}wavelength measurement tolerance: ± 3 nm

^{*2}forward voltage measurement tolerance: ± 3 %

^{*3}output power measurement tolerance: ± 10 %



Performance Characteristics

Forward Current vs. Forward Voltage

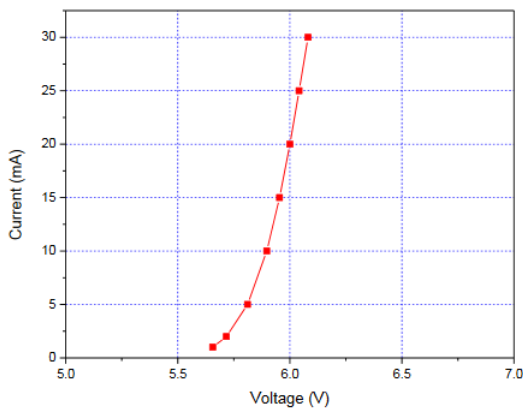

Rel. Optical Power vs. Forward Current

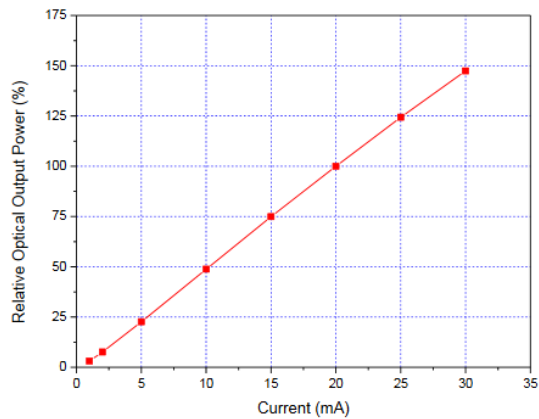

Peak Wavelength vs. Forward Current

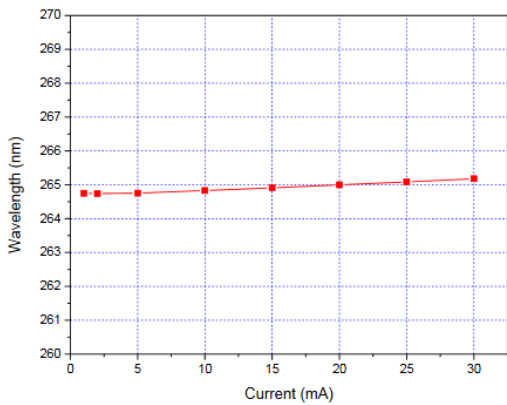

Rel. Optical Power vs. Case Temperature

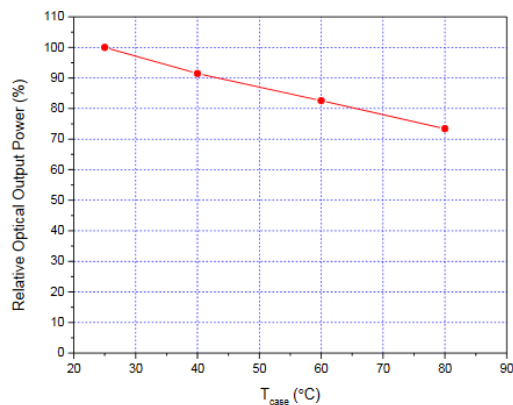

Peak Wavelength vs. case Temperature

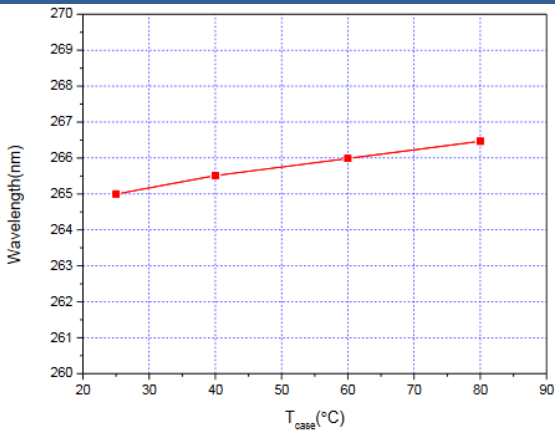

Forward Voltage vs. Case Temperature

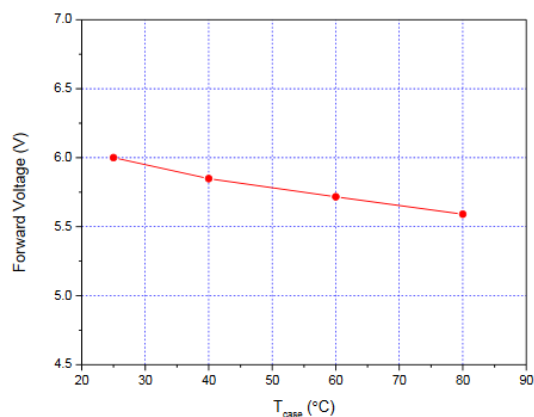



Performance Characteristics

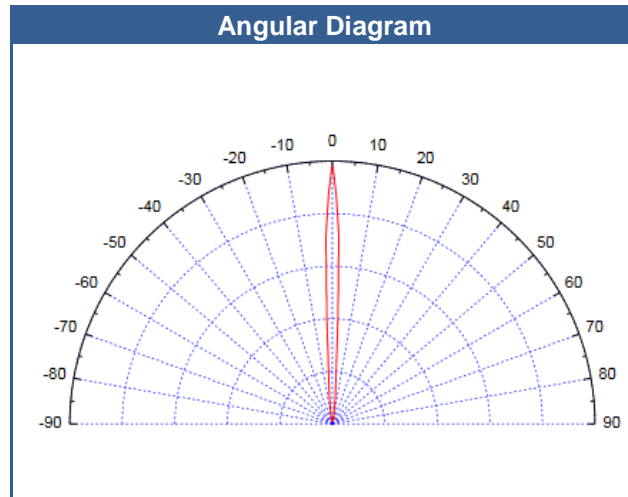
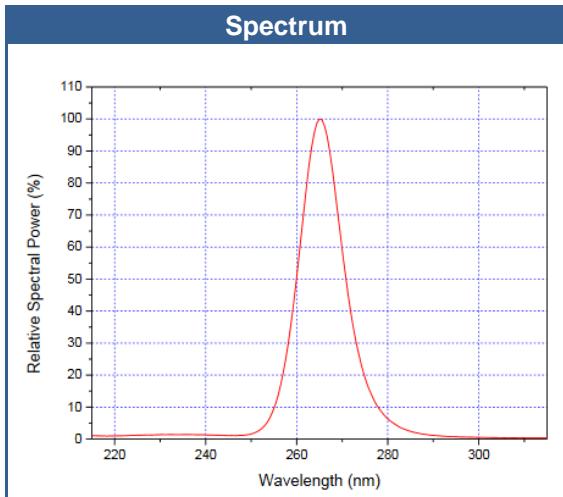

Outline Dimensions

TO-39 hemispherical lens

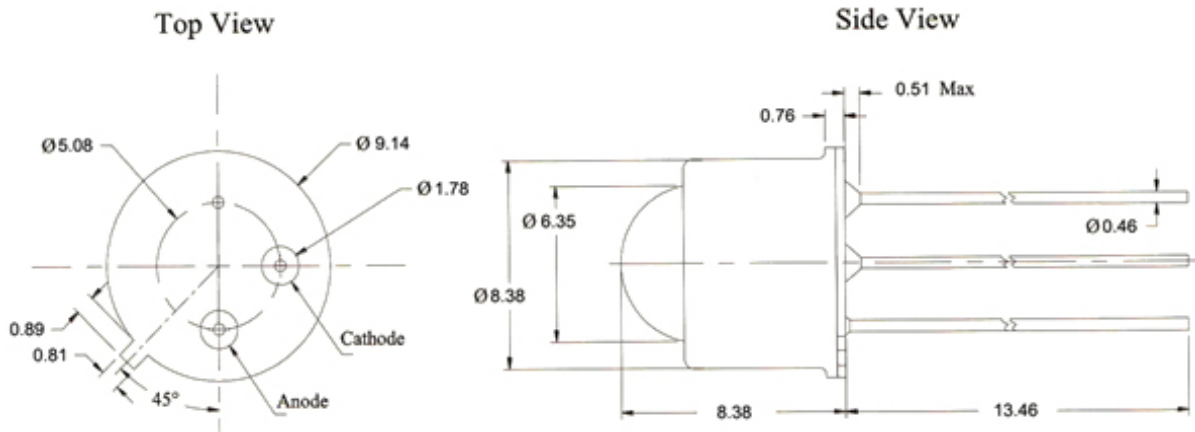

All dimensions in mm

Electrical Connection

Pin #	Function
Pin 1	Anode
Pin 2	Cathode
Pin 3	Case

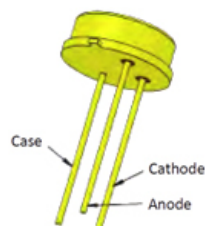

Bottom View:

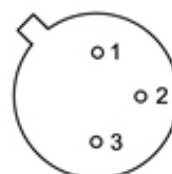



Precautions

Soldering:

- Do avoid overheating of the LED
- Do avoid electrostatic discharge (ESD)
- Do avoid mechanical stress, shock, and vibration
- Do only use non-corrosive flux.
- Do only solder the leads. Soldering of header or cap will damage the LED
- Do only cut the leads at room temperature with an ESD protected tool
- Do not solder closer than 3 mm from base of the header
- Do form leads prior to soldering
- Do not impose mechanical stress on the header when forming the leads
- Do not apply current to the LED until it has cooled down to room temperature after soldering

Recommended soldering conditions:

dip soldering		hand soldering	
pre-heat time	max 30 s	soldering time	max 5 s
dipping time	max 5 s		
solder bath temperature	max 190 °C	solder temperature	max 190 °C

It is strongly advised to perform soldering at the shortest time and lowest temperature possible.



Cleaning:

Cleaning with isopropyl alcohol, propanol, or ethyl alcohol is recommended

DO NOT USE acetone, chloroform, trichloroethylene, or MKS

DO NOT USE ultrasonic cleaners

Static Electricity:

UVTOP are sensitive to electrostatic discharge (ESD). Precautions against ESD must be taken when handling or operating these LEDs. Surge voltage or electrostatic discharge can result in complete failure of the device.

UV-Radiation:

During operation these LEDs do emit **high intensity ultraviolet light**, which is hazardous to skin and eyes, and may cause cancer. Do avoid exposure to the emitted UV light. **Protective glasses are recommended.** It is further advised to attach a warning label on products/systems that do utilize UV-LEDs:



Operation:

Do **only** operate UVTOP LEDs with a current source.

Running these LEDs from a voltage source *will* result in complete failure of the device.

Current of a LED is an exponential function of the voltage across it. Usage of current regulated drive circuits is mandatory





Device Materials

Pin #	Material
Header	Fe-Ni alloy, plated Ni-Au
Leads	Fe-Ni alloy, plated Ni-Au
Bonding wires	Au
Lens	SiO ₂



© All Rights Reserved

The above specifications are for reference purpose only and subjected to change without prior notice