

# FM120-NS THRU FM140-NS

## List

|   |   |
|---|---|
| List.....   | 1 |
| Package outline.....                                    | 2 |
| Features.....   | 2 |
| Mechanical data.....                                    | 2 |
| Maximum ratings .....                                   | 2 |
| Rating and characteristic curves.....                   | 3 |
| Pinning information.....                                | 4 |
| Marking.....  | 4 |
| Suggested solder pad layout.....                        | 4 |
| Packing information.....                                | 5 |
| Reel packing.....                                       | 6 |
| Suggested thermal profiles for soldering processes..... | 6 |
| High reliability test capabilities.....                 | 7 |

# FM120-NS THRU FM140-NS

## 1.0A Surface Mount Schottky Barrier Rectifiers - 20V-40V

### Features

- Batch process design, excellent power dissipation offers better reverse leakage current and thermal resistance.
- Low profile surface mounted application in order to optimize board space.
- Low power loss, high efficiency.
- High current capability, low forward voltage drop.
- High surge capability.
- Guardring for overvoltage protection.
- Very tiny plastic SMD package.
- Ultra high-speed switching.
- Silicon epitaxial planar chip, metal silicon junction.
- Lead-free parts meet environmental standards of MIL-STD-19500 /228
- Suffix "-H" indicates Halogen free parts, ex. FM120-NS-H.

### Mechanical data

- Epoxy:UL94-V0 rated flame retardant
- Case : Molded plastic, SOD-323S
- Terminals : Solder plated, solderable per MIL-STD-750, Method 2026
- Polarity : Indicated by cathode band
- Mounting Position : Any
- Weight : Approximated 0.004 gram

### Package outline

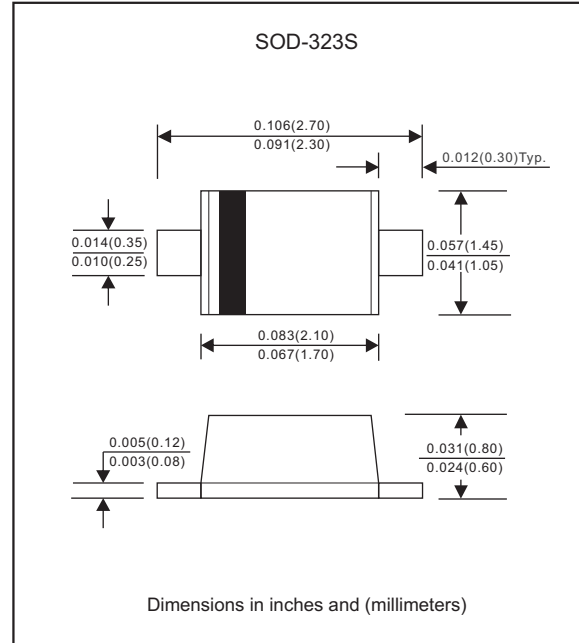

### Maximum ratings and Electrical Characteristics (AT T<sub>A</sub>=25°C unless otherwise noted)

| PARAMETER                  | CONDITIONS  | Symbol           | MIN. | TYP. | MAX.      | UNIT |
|----------------------------|---|------------------|------|------|-----------|------|
| Forward rectified current  | See Fig.1   | I <sub>O</sub>   |      |      | 1.0       | A    |
| Forward surge current      | 8.3ms single half sine-wave (JEDEC methode)   | I <sub>FSM</sub> |      |      | 25        | A    |
| Reverse current            | V <sub>R</sub> = V <sub>RRM</sub> T <sub>J</sub> = 25°C<br>V <sub>R</sub> = V <sub>RRM</sub> T <sub>J</sub> = 100°C | I <sub>R</sub>   |      |      | 0.5<br>10 | mA   |
| Thermal resistance         | Junction to ambient   | R <sub>θJA</sub> |      | 120  |           | °C/W |
|                            | Junction to case  | R <sub>θJC</sub> |      | 100  |           | °C/W |
| Diode junction capacitance | f=1MHz and applied 4V DC reverse voltage  | C <sub>J</sub>   |      | 120  |           | pF   |
| Storage temperature        |   | T <sub>STG</sub> | -65  |      | +175      | °C   |

| SYMBOLS  | V <sub>RRM</sub> <sup>*1</sup><br>(V) | V <sub>RMS</sub> <sup>*2</sup><br>(V) | V <sub>R</sub> <sup>*3</sup><br>(V) | V <sub>F</sub> <sup>*4</sup><br>(V) | Operating temperature<br>T <sub>J</sub> (°C) |
|----------|---------------------------------------|---------------------------------------|-------------------------------------|-------------------------------------|--|
| FM120-NS | 20                                    | 14                                    | 20                                  | 0.55                                | -55 to +125                                  |
| FM130-NS | 30                                    | 21                                    | 30                                  |                                     |  |
| FM140-NS | 40                                    | 28                                    | 40                                  |                                     |  |

- \*1 Repetitive peak reverse voltage
- \*2 RMS voltage
- \*3 Continuous reverse voltage
- \*4 Maximum forward voltage@I<sub>F</sub>=1.0A

## Rating and characteristic curves (FM120-NS THRU FM140-NS)

FIG.1-TYPICAL FORWARD CURRENT DERATING CURVE

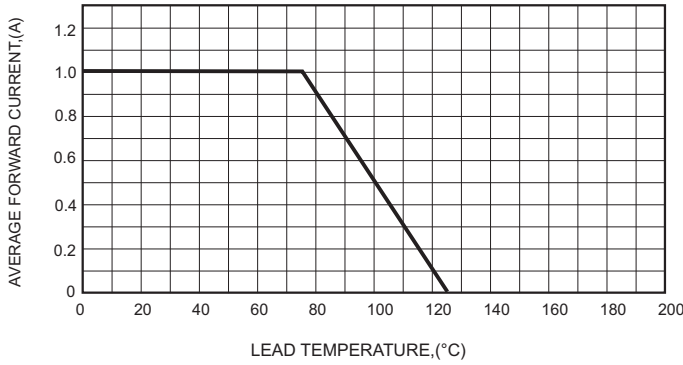

FIG.2-TYPICAL FORWARD CHARACTERISTICS

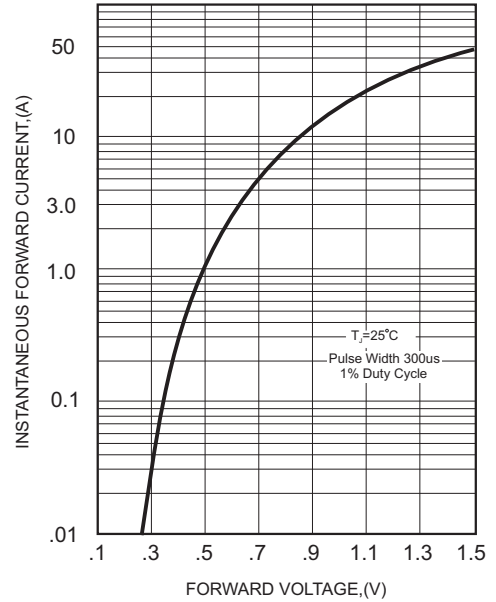

FIG.3-MAXIMUM NON-REPETITIVE FORWARD SURGE CURRENT

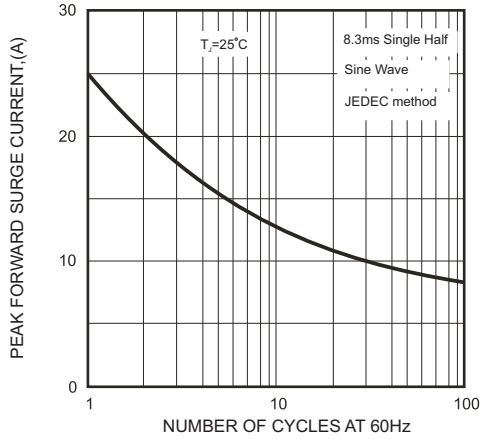

FIG.4-TYPICAL JUNCTION CAPACITANCE

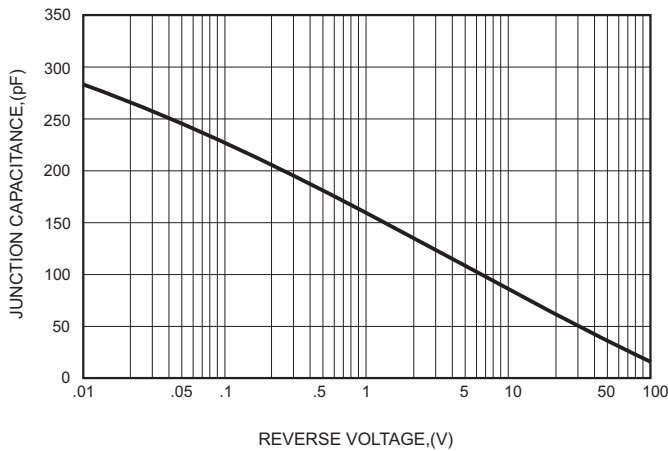
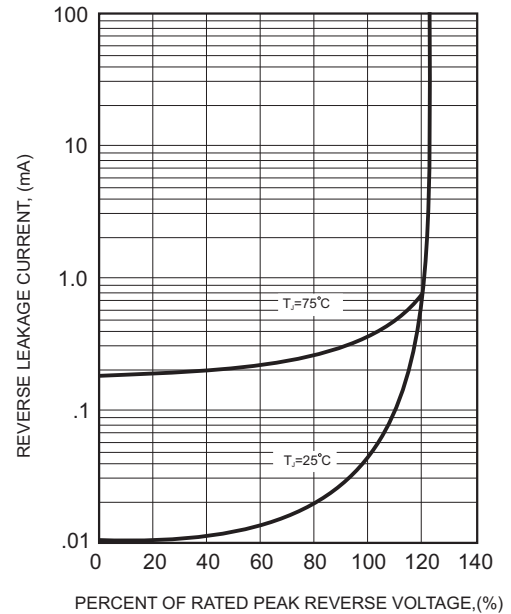



FIG.5 - TYPICAL REVERSE CHARACTERISTICS



# FM120-NS THRU FM140-NS

## Pinning information

| Pin                        | Simplified outline   | Symbol  |
|----------------------------|--|---|
| Pin1 cathode<br>Pin2 anode |  |  |

## Marking

| Type number | Marking code |
|-------------|--------------|
| FM120-NS    | 12           |
| FM130-NS    | 13           |
| FM140-NS    | 14           |

## Suggested solder pad layout

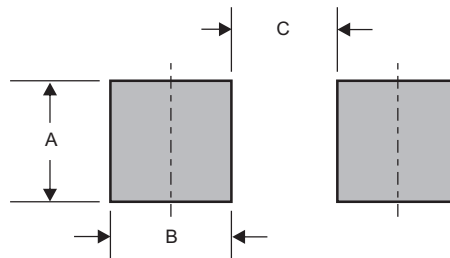

Dimensions in inches and (millimeters)

| PACKAGE  | A            | B            | C            |
|----------|--------------|--------------|--------------|
| SOD-323S | 0.024 (0.60) | 0.031 (0.80) | 0.059 (1.50) |

# FM120-NS THRU FM140-NS

## Packing information

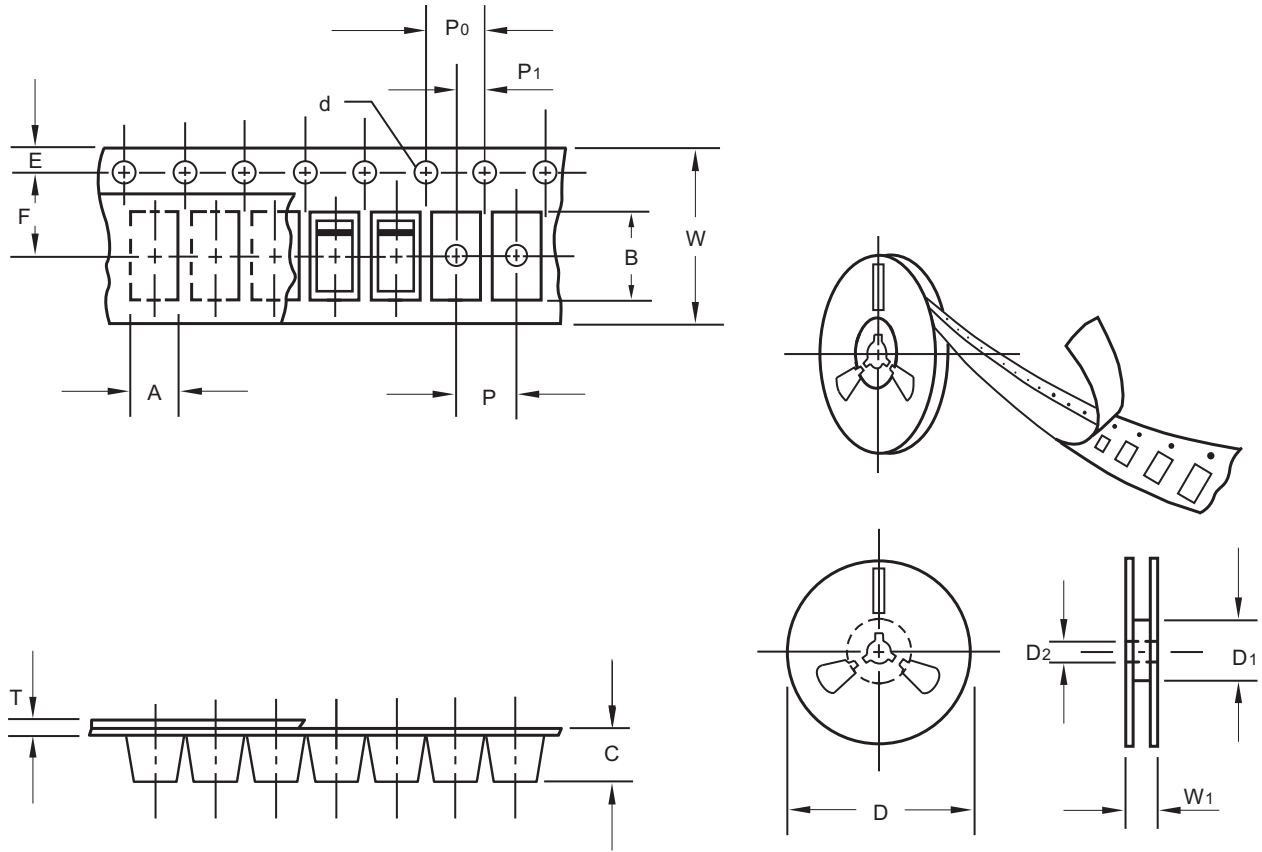

unit:mm

| Item                      | Symbol | Tolerance | SOD-323S |
|---------------------------|--------|-----------|----------|
| Carrier width             | A      | 0.1       | 1.40     |
| Carrier length            | B      | 0.1       | 2.95     |
| Carrier depth             | C      | 0.1       | 0.95     |
| Sprocket hole             | d      | 0.1       | 1.50     |
| 13" Reel outside diameter | D      | 2.0       | -        |
| 13" Reel inner diameter   | D1     | min       | -        |
| 7" Reel outside diameter  | D      | 2.0       | 178.00   |
| 7" Reel inner diameter    | D1     | min       | 62.00    |
| Feed hole diameter        | D2     | 0.5       | 13.00    |
| Sprocket hole position    | E      | 0.1       | 1.75     |
| Punch hole position       | F      | 0.1       | 3.50     |
| Punch hole pitch          | P      | 0.1       | 4.00     |
| Sprocket hole pitch       | P0     | 0.1       | 4.00     |
| Embossment center         | P1     | 0.1       | 2.00     |
| Overall tape thickness    | T      | 0.1       | 0.23     |
| Tape width                | W      | 0.3       | 8.00     |
| Reel width                | W1     | 1.0       | 11.40    |

Note: Devices are packed in accordance with EIA standard RS-481-A and specifications listed above.

# FM120-NS THRU FM140-NS

## Reel packing

| PACKAGE  | REEL SIZE | REEL (pcs) | COMPONENT SPACING (m/m) | BOX (pcs) | INNER BOX (m/m) | REEL DIA, (m/m) | CARTON SIZE (m/m) | CARTON (pcs) | APPROX. GROSS WEIGHT (kg) |
|----------|-----------|------------|-------------------------|-----------|-----------------|-----------------|-------------------|--------------|---------------------------|
| SOD-323S | 7"        | 3,000      | 4.0                     | 30,000    | 183*183*123     | 178             | 382*262*387       | 240,000      | 9.5                       |

## Suggested thermal profiles for soldering processes

- 1.Storage environment: Temperature=5°C~40°C Humidity=55%±25%
- 2.Reflow soldering of surface-mount devices

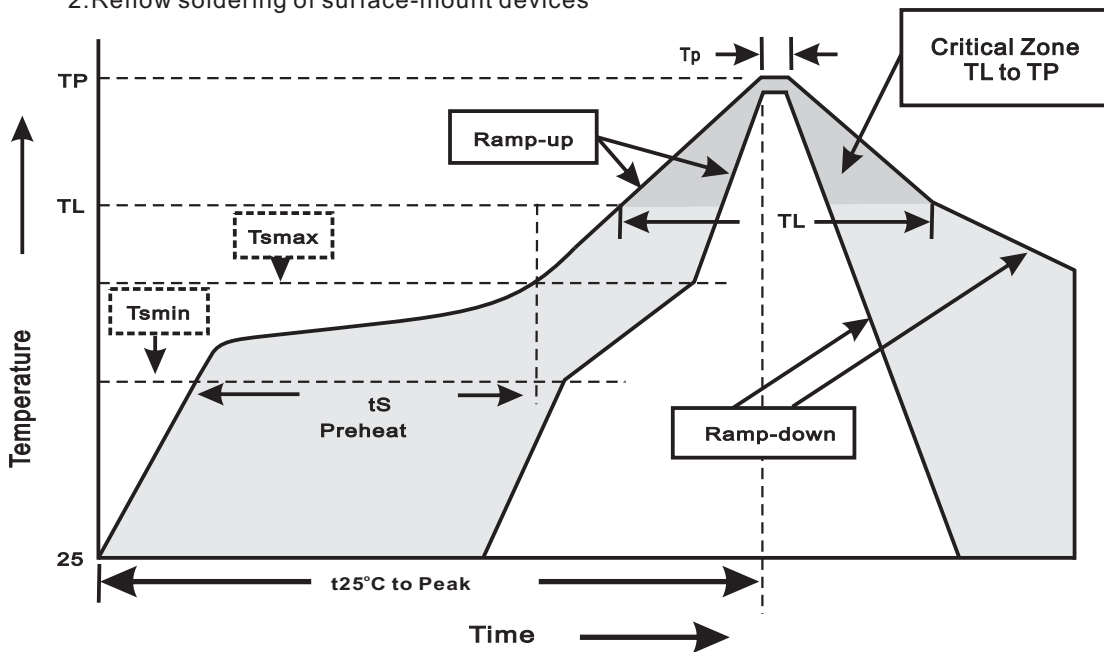

### 3.Reflow soldering

| Profile Feature   | Soldering Condition         |
|---|-----------------------------|
| Average ramp-up rate(T <sub>L</sub> to T <sub>P</sub> )   | <3°C/sec                    |
| Preheat<br>-Temperature Min(T <sub>smín</sub> )<br>-Temperature Max(T <sub>smáx</sub> )<br>-Time(min to max)(t <sub>s</sub> ) | 150°C<br>200°C<br>60~120sec |
| T <sub>smáx</sub> to T <sub>L</sub><br>-Ramp-upRate   | <3°C/sec                    |
| Time maintained above:<br>-Temperature(T <sub>L</sub> )<br>-Time(t <sub>L</sub> )   | 217°C<br>60~260sec          |
| Peak Temperature(T <sub>P</sub> )   | 255°C-0/+5°C                |
| Time within 5°C of actual Peak Temperature(t <sub>P</sub> )   | 10~30sec                    |
| Ramp-down Rate  | <6°C/sec                    |
| Time 25°C to Peak Temperature   | <6minutes                   |

**FM120-NS THRU FM140-NS****High reliability test capabilities**

| Item Test                         | Conditions   | Reference                     |
|-----------------------------------|--|-------------------------------|
| 1. Solder Resistance              | at $260\pm 5^{\circ}\text{C}$ for $10\pm 2\text{sec.}$<br>immerse body into solder $1/16''\pm 1/32''$                                      | MIL-STD-750D<br>METHOD-2031   |
| 2. Solderability                  | at $245\pm 5^{\circ}\text{C}$ for 5 sec.   | MIL-STD-202F<br>METHOD-208    |
| 3. High Temperature Reverse Bias  | $V_R=80\%$ rate at $T_J=125^{\circ}\text{C}$ for 168 hrs.  | MIL-STD-750D<br>METHOD-1038   |
| 4. Forward Operation Life         | Rated average rectifier current at $T_A=25^{\circ}\text{C}$ for 500hrs.  | MIL-STD-750D<br>METHOD-1027   |
| 5. Intermittent Operation Life    | $T_A = 25^{\circ}\text{C}$ , $I_F = I_O$<br>On state: power on for 5 min.<br>off state: power off for 5 min.<br>on and off for 500 cycles. | MIL-STD-750D<br>METHOD-1036   |
| 6. Pressure Cooker                | $15P_{SIG}$ at $T_A=121^{\circ}\text{C}$ for 4 hrs.  | JESD22-A102                   |
| 7. Temperature Cycling            | $-55^{\circ}\text{C}$ to $+125^{\circ}\text{C}$ dwelled for 30 min.<br>and transferred for 5min. total 10 cycles.                          | MIL-STD-750D<br>METHOD-1051   |
| 8. Forward Surge                  | 8.3ms single half sine-wave , one surge.   | MIL-STD-750D<br>METHOD-4066-2 |
| 9. Humidity                       | at $T_A=85^{\circ}\text{C}$ , RH=85% for 1000hrs.  | MIL-STD-750D<br>METHOD-1021   |
| 10. High Temperature Storage Life | at $175^{\circ}\text{C}$ for 1000 hrs.   | MIL-STD-750D<br>METHOD-1031   |