



# IR Emitter and Detector Product Data Sheet

LTE-3220L-032A

Spec No.: DS50-2015-0002

Effective Date: 02/04/2015

Revision: -

**LITE-ON DCC**

**RELEASE**

BNS-OD-FC001/A4

## IR Emitter and Detector LTE-3220I-032A

### 1. Description

Lite-On offers a broad range of discrete infrared components for application such as remote controller, IR wireless data transmission, security alarm & etc. The product line includes GaAs 940nm IREDs, AlGaAs high power 880nm IREDs, AlGaAs high speed 875nm/850nm IREDs, PIN Photodiodes, Phototransistor and Photodarlington.

#### 1.1. Features

- Lead (Pb) free product and RoHS compliant.
- High speed
- Narrow radiation angle
- Available for pulse operating
- Clear transparent

#### 1.2. Applications

- IR emitter

### 2. Outline Dimensions

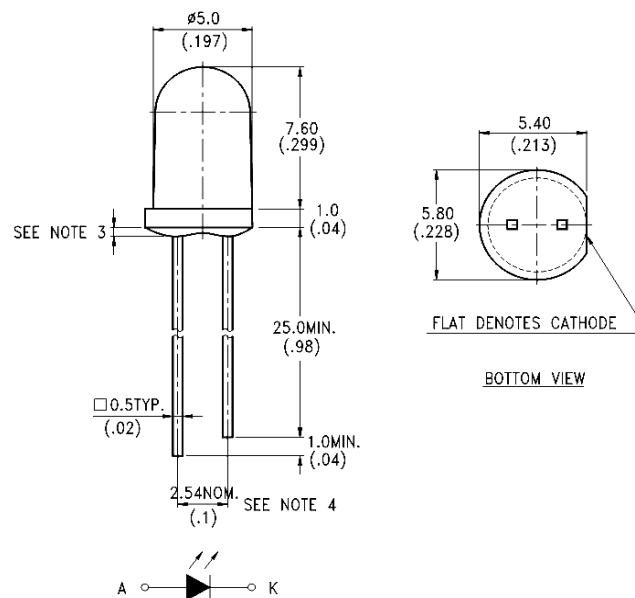

#### Notes :

1. All dimensions are in millimeters (inches).
2. Tolerance is  $\pm 0.25$ mm (.010") unless otherwise noted.
3. Protruded resin under flange is 1.5mm (.059") max.
4. Lead spacing is measured where the leads emerge from the package.
5. Specifications are subject to change without notice.

## IR Emitter and Detector LTE-3220I-032A

### 3. Absolute Maximum Ratings at TA=25°C

Parameter	Maximum Rating	Unit
Power Dissipation	150	mW
Peak Forward Current (300pps, 10µs pulse)	1	A
Continuous Forward Current	100	mA
Reverse Voltage	5	V
Operating Temperature Range	-40°C to + 85°C	
Storage Temperature Range	-55°C to + 100°C	
Lead Soldering Temperature [4.0mm (.157") From Body]	260°C for 5 Seconds	

### 4. Electrical / Optical Characteristics at TA=25°C

Parameter	Symbol	Min.	Typ.	Max.	Unit	Test Condition
Radiant Intensity	I <sub>e</sub>	18	24		mW/sr	I <sub>F</sub> = 20mA
		45	60			I <sub>F</sub> = 50mA
Peak Emission Wavelength	λ <sub>Peak</sub>		850		nm	I <sub>F</sub> = 50mA
Spectral Line Half-Width	Δλ		50		nm	I <sub>F</sub> = 50mA
Forward Voltage	V <sub>f</sub>		1.5	2.0	V	I <sub>F</sub> = 50mA
Reverse Current	I <sub>R</sub>			100	µA	V <sub>R</sub> = 5V
Viewing Angle (See Fig.6)	2θ <sub>1/2</sub>		30		deg.	

# IR Emitter and Detector LTE-3220I-032A

## 5. Typical Electrical / Optical Characteristics Curves

(25°C Ambient Temperature Unless Otherwise Noted)

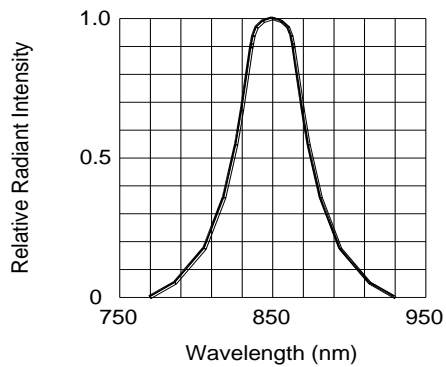

FIG.1 SPECTRAL DISTRIBUTION

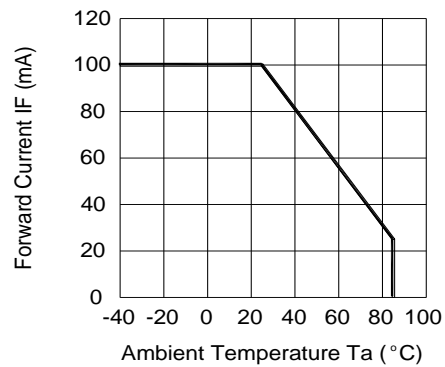

FIG.2 FORWARD CURRENT VS. AMBIENT TEMPERATURE

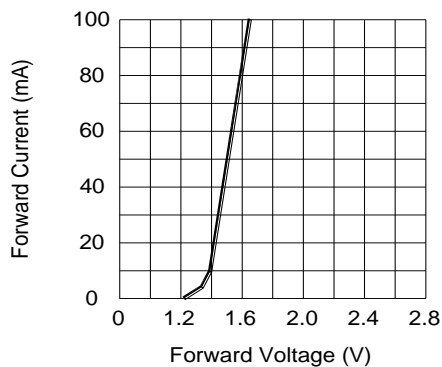

FIG.3 FORWARD CURRENT VS. FORWARD VOLTAGE

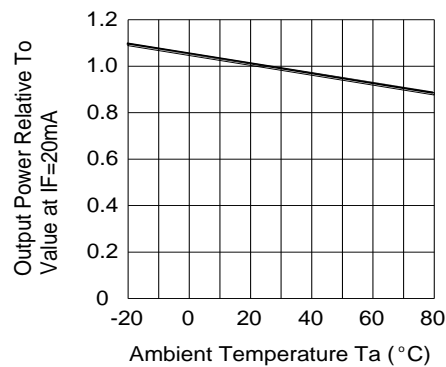

FIG.4 RELATIVE RADIANT INTENSITY VS. AMBIENT TEMPERATURE

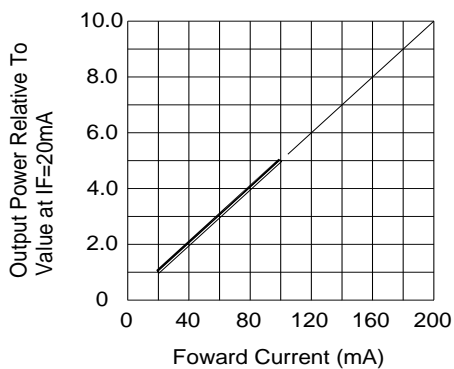

FIG.5 RELATIVE RADIANT INTENSITY VS. FORWARD CURRENT

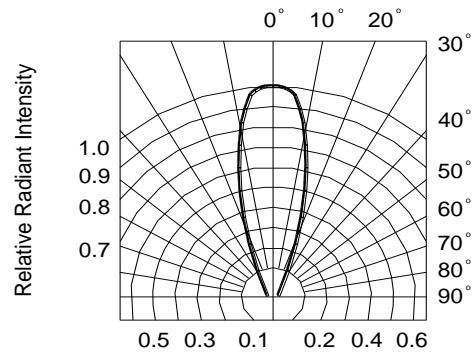
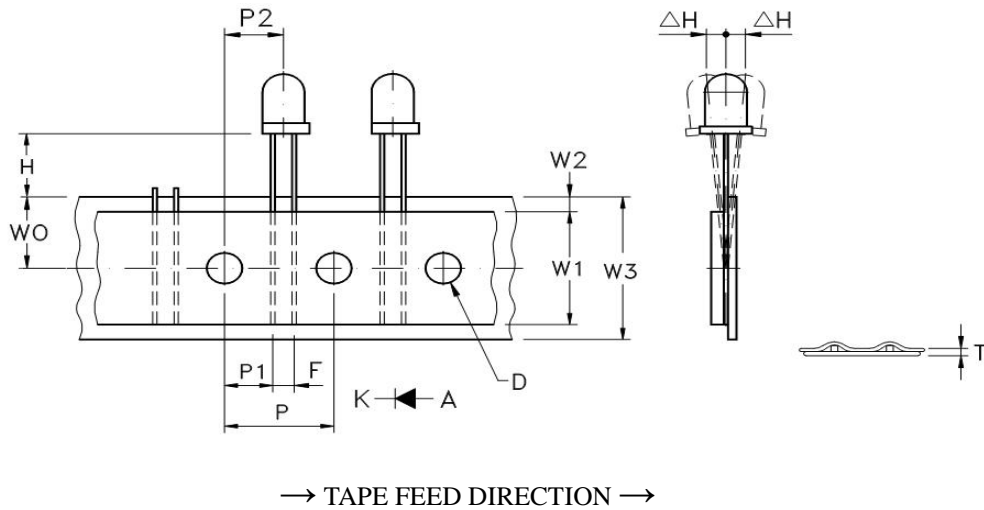

FIG.6 RADIATION DIAGRAM

IR Emitter and Detector  
LTE-3220I-032A

6. PACKAGE DIMENSIONS



Items	Symbol	Specification			
		Minimum		Maximum	
		mm	inch	mm	inch
Tape Feed Hole Diameter	D	3.8	0.149	4.2	0.165
Component Lead Pitch	F	2.3	0.091	3.0	0.118
Front To Rear Deflection	$\Delta H$	--	--	2.0	0.078
Top Edge Of Base Paper To Bottom Of Component	H	10.5	0.413	11.5	0.453
Feed Hole Pitch	P	12.5	0.492	12.9	0.508
Lead Location	P1	4.4	0.173	5.8	0.228
Center Of Component Location	P2	5.05	0.198	7.65	0.301
Total Tape Thickness	T	--	--	0.90	0.035
Feed Hole Location	W0	8.5	0.334	9.5	0.374
Adhesive Tape Width	W1	12.5	0.492	13.5	0.531
Adhesive Tape Position	W2	0	0	3.0	0.118
Tape Width	W3	17.5	0.689	19.0	0.748