

SLH Single and Dual DC-DC Converters

28 VOLT INPUT – 1.5 WATT

FEATURES

- Radiation tolerant space dc-dc converter
Single event effects (SEE) LET performance to 86 MeV cm²/mg
Total ionizing dose (TID) guaranteed per MIL-STD-883 method 1019, radiation hardness assurance (RHA)
L = 50 krad(Si), R = 100 krad(Si)
- Operating temperature -55°C to +125°C
- Qualified to MIL-PRF-38534 Class H and K
- Input voltage range 16 to 40 V
- Transient protection 50 V for 50 ms
- Fully isolated magnetic feedback
- Fixed high frequency switching
- Inhibit function
- Indefinite short circuit protection



MODELS	
OUTPUT VOLTAGE (V)	
SINGLES	DUALS
5	±5
12	±12
15	±15

DESCRIPTION

With a miniature footprint of just 0.79 square inches, the Interpoint® SLH Series™ of 28 volt dc-dc converters delivers 1.5 watts of output power while saving significant board area. The wide input voltage range of 16 to 40 volts accepts the varying voltages of space, military, or aerospace bus power and tightly regulates output voltages to protect downstream components. Single output models feature outputs of 5, 12, or 15 volts, and dual output models feature outputs of ±5, ±12 and ±15 volts.

SCREENING

SLH converters offer screening to Class H or K and radiation hardness assurance (RHA) levels L - 50 krad(Si) or R - 100 krad(Si). Single event effects (SEE) LET performance to 86 MeV cm²/mg. See Table 9 on page 12 for more information.

CONVERTER DESIGN

SLH Series dc-dc converters incorporate a flyback topology with a variable switching frequency. Feedback provides output voltage regulation. Output voltage is magnetically fed back to the input side of the PWM to regulate output voltage.

Up to 80% of the load of the dual output models may be on one output providing that the other output carries a minimum of 20% of the total load. The dual models can be used as a single output voltage by connecting the load between positive and negative outputs, leaving the common unconnected resulting in double the output voltage. (for example, SLH2805D can be used as a 10 volt output.)

When used with Interpoint's STF28-461 filter, the combination will meet the requirements of MIL-STD-461C, CE03.

INHIBIT FUNCTION

The SLH Series incorporates an inhibit terminal that can be used to disable internal switching. The converter is inhibited when an active low (≤ 0.5 V) signal is applied to the inhibit pin (pin 7). In the inhibit mode the inhibit pin sources up to 2 mA maximum. The converter resumes normal operation when an open circuit is applied to the inhibit pin. The open circuit voltage of the inhibit is 7 to 8 volts. Do not apply an external pull-up to the converter.

PROTECTION FEATURES

All models include a soft-start function to prevent large current draw and minimize overshoot. The converters provide short circuit protection (by restricting the current) and output overload protection.

CONVENIENT PACKAGING

The SLH Series converters are packaged in hermetically sealed metal cases which provide EMI/RFI shielding.

SLH Single and Dual DC-DC Converters

28 VOLT INPUT – 1.5 WATT

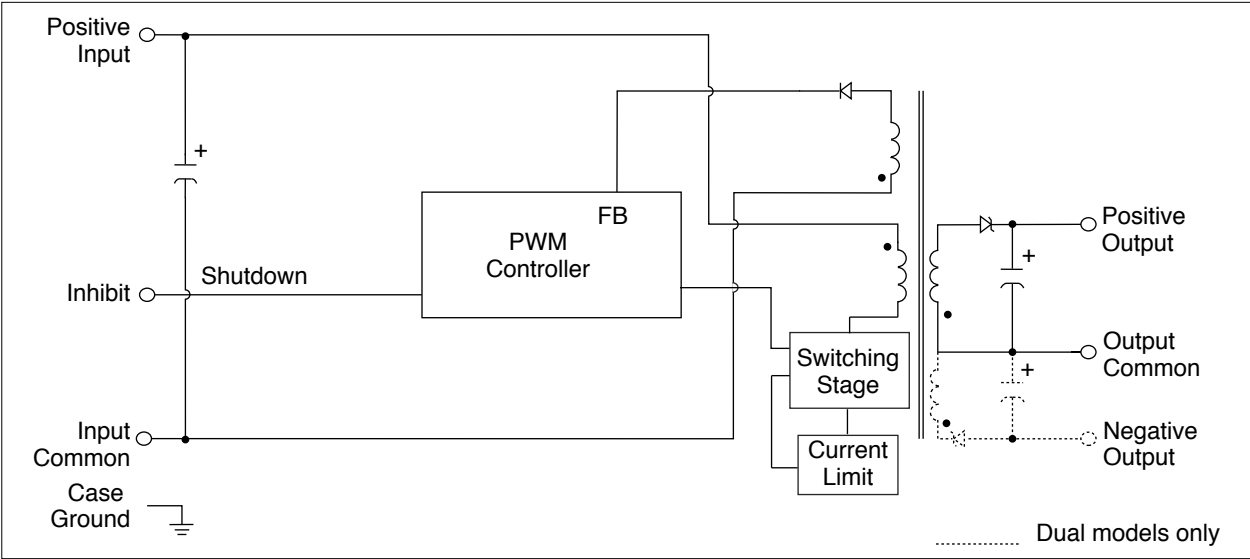
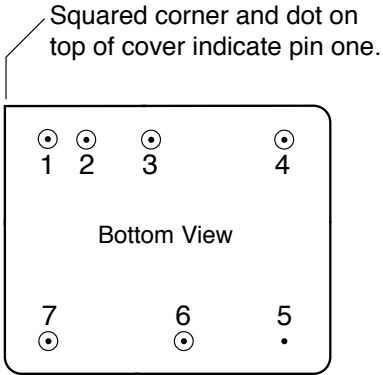

FIGURE 1: SLH BLOCK DIAGRAM

PIN OUT		
Pin	Single Output	Dual Output
1	Positive Input	Positive Input
2	Input Common	Input Common
3	Positive Output	Positive Output
4	Output Common	Output Common
5	Case Ground	Case Ground
6	No Connection	Negative Output
7	Inhibit	Inhibit

TABLE 1: PIN OUT



See Figure 22 on page 10 for dimensions.

FIGURE 2: PIN OUT

PINS NOT IN USE	
Inhibit	Leave unconnected
“No Connection” pin	Leave unconnected

TABLE 2: PINS NOT IN USE

SLH Single and Dual DC-DC Converters

28 VOLT INPUT – 1.5 WATT

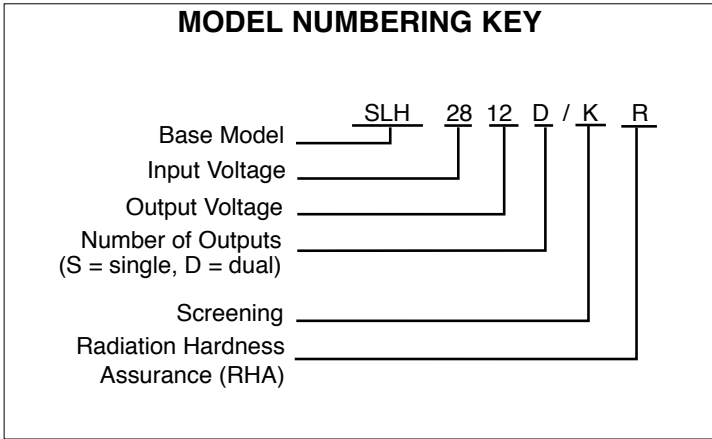

FIGURE 3: MODEL NUMBERING KEY

SMD NUMBERS	
STANDARD MICROCIRCUIT DRAWING (SMD)	SLH SIMILAR PART
5962R0052601KXC	SLH2805S/KR
5962R0052701KXC	SLH2812S/KR
5962R0052801KXC	SLH2815S/KR
5962R0250401KXC	SLH2805D/KR
5962R9955601KXC	SLH2812D/KR
5962R9852901KXC	SLH2815D/KR

The SMD number shown is for Class K screening and radiation hardness assurance (RHA) level R. See the SMD for the numbers for other screening and radiation levels. For exact specifications for an SMD product, refer to the SMD drawing. SMDs can be downloaded from www.landandmaritime.dla.mil/programs/smcr

TABLE 3: SMD NUMBER CROSS REFERENCE

MODEL NUMBER OPTIONS					
ON THE LINES BELOW, ENTER ONE SELECTION FROM EACH CATEGORY TO DETERMINE THE MODEL NUMBER.					
CATEGORY	Base Model and Input Voltage	Output Voltage	Number of Outputs ¹	Screening ²	RHA ³
OPTIONS	SLH28	05, 12, 15	S	O	O
		05, 12, 15	D	H K	L R
FILL IN FOR MODEL #	SLH28	_____	_____	/ _____	_____

Notes:
 1. Number of Outputs: S is a single output and D is a dual output.
 2. Screening: A screening level of O is a Space Prototype and is only used with RHA O. See Table 8 on page 11 and Table 9 on page 12 for more information.
 3. RHA: Interpoint model numbers use an "O" in the RHA designator position to indicate the "-" (dash) RHA level of MIL-PRF-38534, which is defined as "no RHA." RHA O is only available with Screening level O. See Table 9 on page 12 for more information.

TABLE 4: SMD NUMBER CROSS REFERENCE

SLH Single and Dual DC-DC Converters

28 VOLT INPUT – 1.5 WATT

TABLE 5: OPERATING CONDITIONS - ALL MODELS, 25°C CASE, 28 VOLTS VIN, UNLESS OTHERWISE SPECIFIED

PARAMETER	CONDITIONS	ALL MODELS			UNITS
		MIN	TYP	MAX	
LEAD SOLDERING TEMPERATURE ¹	10 SECONDS MAX.	—	—	300	°C
STORAGE TEMPERATURE		-65	—	+150	°C
CASE OPERATING TEMPERATURE	FULL POWER	-55	—	+125	°C
	ABSOLUTE ¹	-55	—	+135	
DERATING OUTPUT POWER/CURRENT ¹	LINEARLY	From 100% at 125°C to 0% at 135°C			
ESD RATING ¹ MIL-PRF-38534, 3.9.5.8.2	MIL-STD-883 METHOD 3015 CLASS 3B	—	—	≥8000	V
ISOLATION, INPUT TO OUTPUT OR ANY PIN TO CASE EXCEPT CASE PIN	@ 500 VDC AT 25°C	100	—	—	Megohms
INPUT TO OUTPUT CAPACITANCE ¹		—	100 - 170	—	pF
CONVERSION FREQUENCY -55° TO +125°C	5, 12, 15, ±5 AND ±15	220	280	320	kHz
	±12	220	—	420	
INHIBIT ACTIVE LOW (OUTPUT DISABLED) Do not apply a voltage to the inhibit pin ²	INHIBIT PIN PULLED LOW	—	—	0.5	V
	INHIBIT PIN SOURCE CURRENT ¹	—	—	2	mA
	REFERENCED TO	INPUT COMMON			
INHIBIT ACTIVE HIGH (OUTPUT ENABLED) Do not apply a voltage to the inhibit pin ²	INHIBIT PIN CONDITION	OPEN COLLECTOR OR UNCONNECTED			
	OPEN INHIBIT PIN VOLTAGE ¹	7	—	8	V

**For mean time between failures (MTBF) contact Applications Engineering
powerapps@crane-eg.com +1 425-882-3100 option 7**

Notes:

1. Guaranteed by qualification test and/or analysis. Not an in-line test.
2. An external inhibit interface should be used to pull the inhibit low or leave it floating. The inhibit pin can be left unconnected if not used. Do not apply an external pull-up.

SLH Single and Dual DC-DC Converters

28 VOLT INPUT – 1.5 WATT

TABLE 6: ELECTRICAL CHARACTERISTICS: -55° TO +125°C CASE, 28 VDC VIN, 100% LOAD, UNLESS OTHERWISE SPECIFIED

SINGLE OUTPUT MODELS		SLH2805S			SLH2812S			SLH2815S			UNITS
PARAMETER	CONDITIONS	MIN	TYP	MAX	MIN	TYP	MAX	MIN	TYP	MAX	
OUTPUT VOLTAGE ²		4.80	5.00	5.20	11.52	12.00	12.48	14.40	15.00	15.60	V
OUTPUT CURRENT	V _{IN} = 16 TO 40 V	—	—	300	—	—	125	—	—	100	mA
OUTPUT POWER	V _{IN} = 16 TO 40 V	—	—	1.5	—	—	1.5	—	—	1.5	W
OUTPUT RIPPLE	T _C = 25°C	—	65	150	—	35	200	—	60	200	mV p-p
10 kHz - 2 MHz	T _C = -55°C TO +125°C	—	—	250	—	—	300	—	—	300	
LINE REGULATION	V _{IN} = 16 TO 40 V	—	115	300	—	60	400	—	60	650	mV
LOAD REGULATION ³	LOAD 10% TO 100%	—	440	700	—	380	700	—	410	700	mV
INPUT VOLTAGE	NO LOAD TO FULL CONTINUOUS	16	28	40	16	28	40	16	28	40	V
	TRANSIENT ¹ 50 ms	—	—	50	—	—	50	—	—	50	V
INPUT CURRENT	NO LOAD	—	2.9	17	—	2.3	17	—	2.4	17	mA
	INHIBITED	—	1.3	5	—	1.3	5	—	1.3	5	
INPUT RIPPLE CURRENT ⁴	10 kHz - 10 MHz	—	85	250	—	75	300	—	60	300	mA p-p
EFFICIENCY	T _C = 25°C	72	79	—	80	87	—	80	88	—	%
	T _C = -55°C TO +125°C	69	—	—	69	—	—	69	—	—	
LOAD FAULT ⁵	SHORT CIRCUIT POWER DISSIPATION	—	0.4	1.5	—	0.3	1.2	—	0.3	1.2	W
	RECOVERY ¹	—	—	30	—	—	30	—	—	30	ms
STEP LOAD RESPONSE	TRANSIENT ⁷	—	±250	±400	—	±220	±700	—	±220	±700	mV pk
	50% - 100% - 50%	RECOVERY ^{1, 6}	—	—	400	—	—	400	—	—	400
STEP LINE RESPONSE ¹	TRANSIENT ⁷	—	—	±600	—	—	±600	—	—	±600	mV pk
	16 - 40 - 16 V	RECOVERY ⁶	—	—	500	—	—	500	—	—	
START-UP ⁸	DELAY	—	1	20	—	1	20	—	1	20	ms
	OVERSHOOT ¹	—	—	100	—	—	500	—	—	500	mV pk
CAPACITIVE LOAD ¹	NO EFFECT ON DC PERFORMANCE	—	—	100	—	—	100	—	—	100	μF

Notes:

- Guaranteed by characterization test and/or analysis. Not a production test.
- Specified at 50% load.
- Although no minimum load is required, at no load the output voltage may exceed rating by up to 15%.
- An external 6 μH inductor, added in series to the input, is necessary to maintain specifications.

- Load fault is a short circuit into 1Ω. Recovery is into resistive full load.
- Recovery is time to settle to within 1% of V_{OUT} final value.
- Transition time > 10 μs.
- Measured from release of inhibit until V_{OUT} settles to within 1% of final value at full load with V_{IN} at 28 V.

SLH Single and Dual DC-DC Converters

28 VOLT INPUT – 1.5 WATT

TABLE 7: ELECTRICAL CHARACTERISTICS: -55° TO +125°C CASE, 28 VDC V_{IN} , 100% LOAD, UNLESS OTHERWISE SPECIFIED

DUAL OUTPUT MODELS		SLH2805D			SLH2812D			SLH2815D			UNITS
PARAMETER	CONDITIONS	MIN	TYP	MAX	MIN	TYP	MAX	MIN	TYP	MAX	
OUTPUT VOLTAGE ²	$\pm V_{OUT}$	4.80	5.00	5.20	11.52	12.00	12.48	14.40	15.00	15.60	V
OUTPUT CURRENT ³ $V_{IN} = 16$ TO 40 V	EACH OUTPUT	—	150	240	—	62.5	100	—	50	80	mA
	TOTAL			300			125			100	
OUTPUT POWER ³ $V_{IN} = 16$ TO 40 V	EACH OUTPUT	—	0.75	1.2	—	0.75	1.2	—	0.75	1.2	W
	TOTAL			1.5			1.5			1.5	
OUTPUT RIPPLE 10 kHz - 2 MHz $\pm V_{OUT}$	$T_C = 25^\circ\text{C}$	—	—	250	—	—	400	—	—	500	mV p-p
	$T_C = -55^\circ\text{C}$ TO $+125^\circ\text{C}$	—	—	250	—	—	400	—	—	500	
LINE REGULATION $\pm V_{OUT}$	$V_{IN} = 16$ TO 40 V	—	75	400	—	75	700	—	85	650	mV
LOAD REGULATION ⁴ 10% - 100%	BALANCED LOADS	—	310	700	—	350	700	—	370	700	mV
	$\pm V_{OUT}$										
INPUT VOLTAGE	CONTINUOUS NO LOAD TO FULL	16	28	40	16	28	40	16	28	40	V
	TRANSIENT ¹ 50 ms	0	—	50	0	—	50	0	—	50	
INPUT CURRENT	NO LOAD	—	3.1	17	—	3.1	17	—	3.3	17	mA
	INHIBITED	—	1.4	5	—	1.4	5	—	1.4	5	
INPUT RIPPLE CURRENT ⁵	10 kHz - 10 MHz	—	80	250	—	90	300	—	100	300	mA p-p
EFFICIENCY	$T_C = 25^\circ\text{C}$	72	75	—	80	87	—	80	87	—	%
	$T_C = -55^\circ\text{C}$ TO $+125^\circ\text{C}$	69	—	—	69	—	—	69	—	—	
LOAD FAULT ⁶	SHORT CIRCUIT POWER DISSIPATION	—	0.3	1.5	—	0.3	1.2	—	0.3	1.2	W
	RECOVERY ¹	—	—	30	—	1	30	—	1	30	
STEP LOAD RESPONSE BALANCED LOADS 50% - 100% - 50% $\pm V_{OUT}$	TRANSIENT ⁸	—	± 150	± 400	—	± 170	± 600	—	± 200	± 700	mV pk
	RECOVERY ^{1, 7}	—	—	600	—	—	360	—	—	600	
STEP LINE RESPONSE ¹ 16 - 40 - 16 V, $\pm V_{OUT}$	TRANSIENT ⁸	—	—	± 600	—	—	± 600	—	—	± 600	mV pk
	RECOVERY ⁷	—	—	500	—	—	500	—	—	500	
START-UP ⁹ $\pm V_{OUT}$	DELAY	—	1	20	—	2	20	—	2	20	ms
	OVERSHOOT ¹	—	—	500	—	—	500	—	—	500	
CAPACITIVE LOAD ¹ $T_C = 25^\circ\text{C}$, EACH OUTPUT	NO EFFECT ON DC PERFORMANCE	—	—	100	—	—	100	—	—	100	μF

Notes

- Guaranteed by characterization test and/or analysis. Not a production test.
- Specified at 50%/50% balanced loads, one half of full load.
- Maximum specification indicates 80% of the converter's total current/power is available from either output, provided the other output carries 20% of the total power.
- Although no minimum load is required, at no load the output voltage may exceed rating by up to 15%.
- An external 6 μH inductor, added in series to the input, is necessary to maintain specifications.
- Load fault is a short circuit into 1 Ω . Recovery is into resistive full load.
- Recovery is time for $\pm V_{OUT}$ to settle to within 1% of final value.
- Transition time > 10 μs .
- Measured from release of inhibit until V_{OUT} settles to within 1% of final value at full load with V_{IN} at 28 V.

SLH Single and Dual DC-DC Converters

28 VOLT INPUT – 1.5 WATT

ELECTRICAL CHARACTERISTICS: -55° TO +125°C CASE, 28 VDC V_{IN} , 100% LOAD, UNLESS OTHERWISE SPECIFIED
THESE ARE EXAMPLES FOR REFERENCE ONLY AND ARE NOT GUARANTEED SPECIFICATIONS

EMI: Representative of all SLH Models

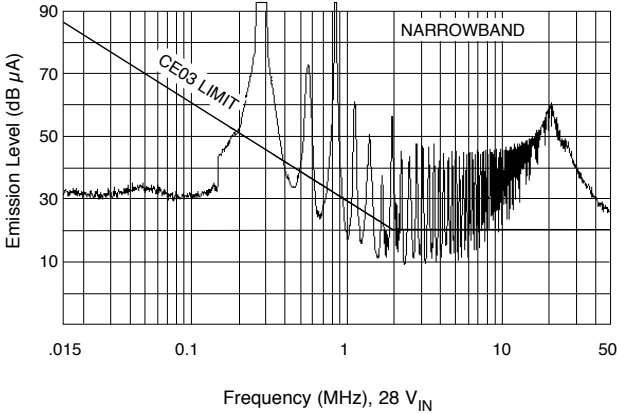

SLH2805S Unfiltered
FIGURE 4

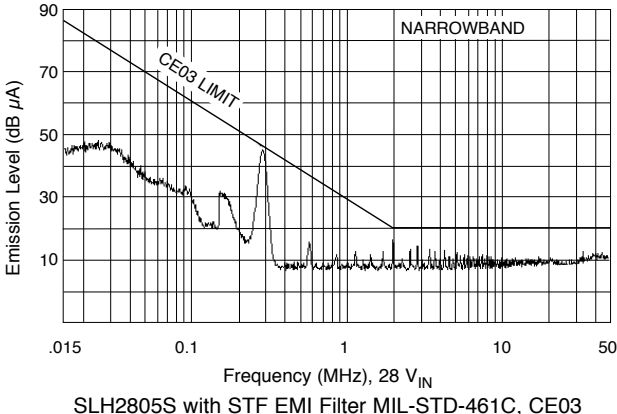

SLH2805S with STF EMI Filter MIL-STD-461C, CE03
FIGURE 5

SLH Single and Dual DC-DC Converters

28 VOLT INPUT – 1.5 WATT

ELECTRICAL CHARACTERISTICS: -55° TO +125°C CASE, 28 VDC VIN, 100% LOAD, UNLESS OTHERWISE SPECIFIED
 THESE ARE EXAMPLES FOR REFERENCE ONLY AND ARE NOT GUARANTEED SPECIFICATIONS

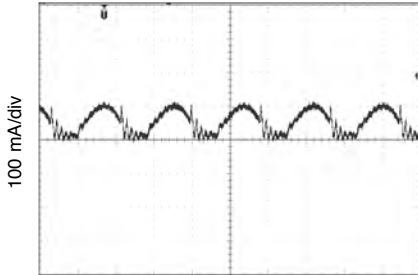

2 μs/div
 6 μH inductor in series with input
 Representative of Single Input Ripple Current
FIGURE 6

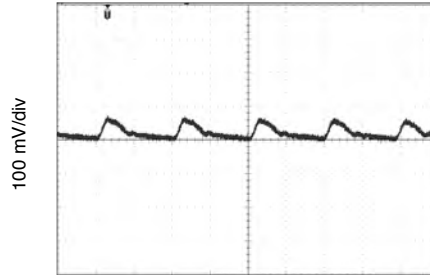

2 μs/div
 Representative of Single Output Ripple Voltage
FIGURE 7

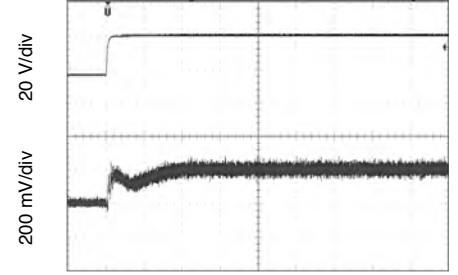

100 μs/div
 Vin 16 to 40 to 16 Volts, full resistive load
 Representative of Single Output Line Transient
FIGURE 8

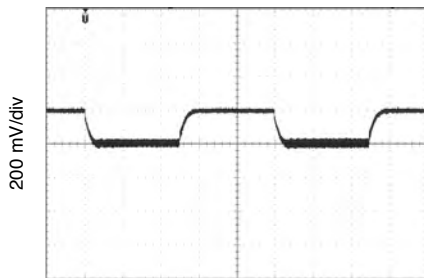

400 μs/div
 Representative of Single Output Load Transient
FIGURE 9

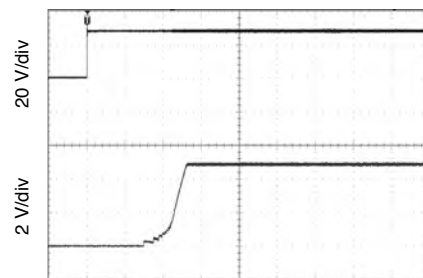

1 ms/div
 Representative of Single Output Turn-On Delay
FIGURE 10

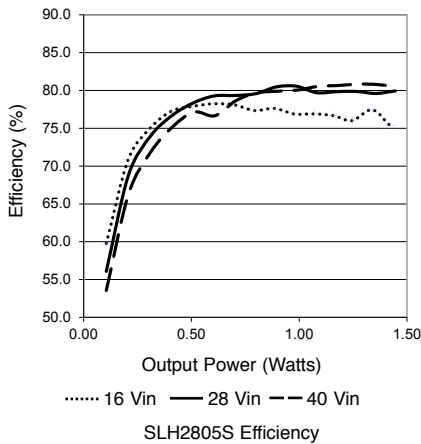

FIGURE 11

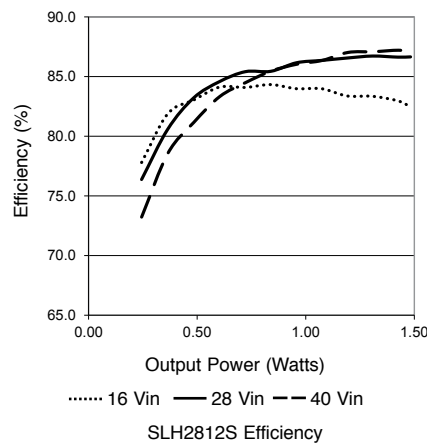

FIGURE 12

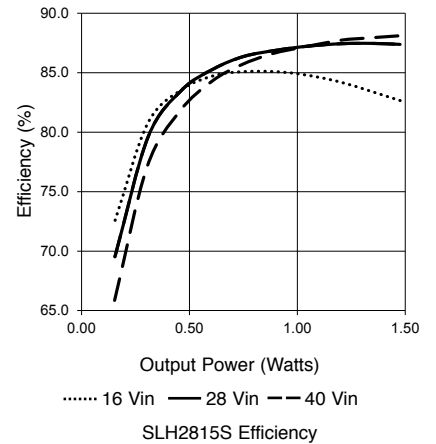
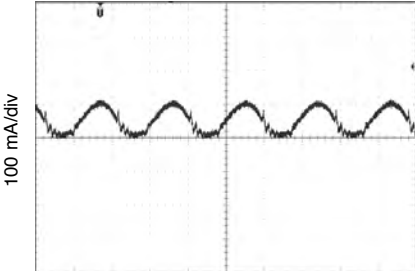

FIGURE 13

SLH Single and Dual DC-DC Converters

28 VOLT INPUT – 1.5 WATT

ELECTRICAL CHARACTERISTICS: -55° to +125°C CASE, 28 VDC VIN, 100% LOAD, UNLESS OTHERWISE SPECIFIED
 THESE ARE EXAMPLES FOR REFERENCE ONLY AND ARE NOT GUARANTEED SPECIFICATIONS



2 μ s/div

6 μ H inductor in series with input

Representative of Dual Input Ripple Current

FIGURE 14

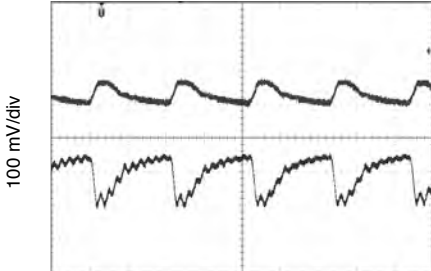

2 μ s/div

Representative of Dual Output Ripple Voltage

FIGURE 15

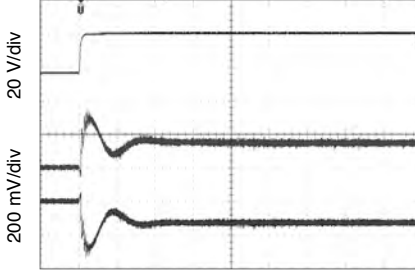

100 μ s/div

Vin 16 to 40 to 16 Volts, full resistive load
 Representative of Single Output Line Transient

FIGURE 16

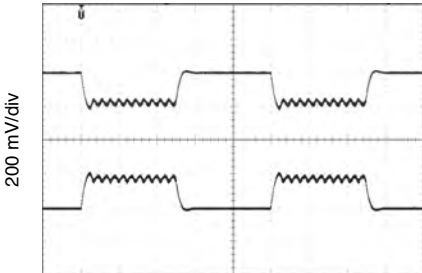

400 μ s/div

Representative of Dual Output Load Transient

FIGURE 17

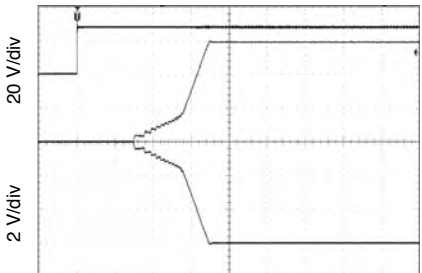

1 ms/div

Representative of Dual Output Turn-On Delay

FIGURE 18

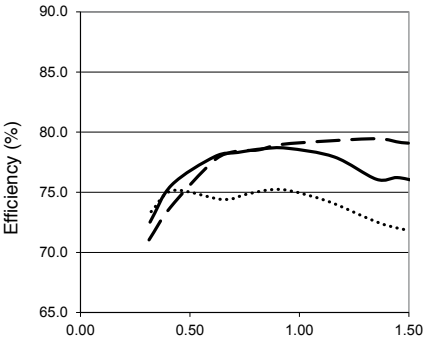

Output Power (Watts)
 16 Vin — 28 Vin - - 40 Vin
 SLH2805D Efficiency

FIGURE 19

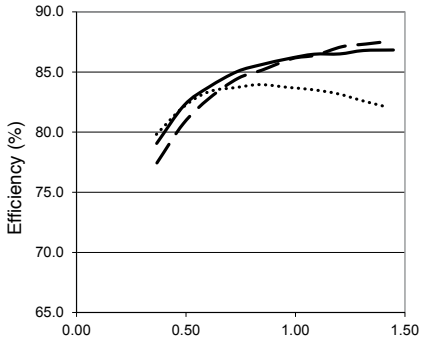

Output Power (Watts)
 16 Vin — 28 Vin - - 40 Vin
 SLH2812D Efficiency

FIGURE 20

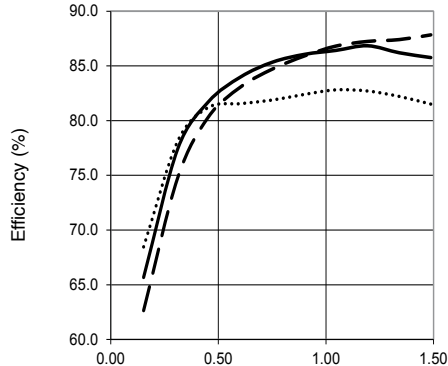

Output Power (Watts)
 16 Vin — 28 Vin - - 40 Vin
 SLH2815D Efficiency

FIGURE 21

SLH Single and Dual DC-DC Converters

28 VOLT INPUT – 1.5 WATT

BOTTOM VIEW CASE A2

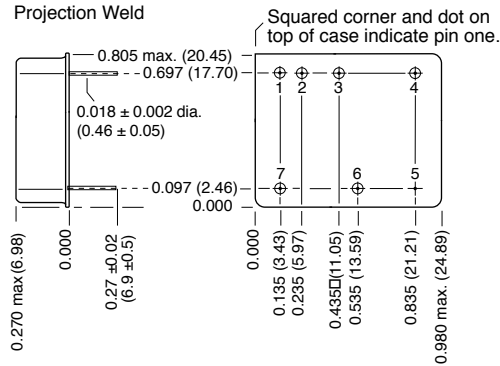

Weight: 12 grams typical

Case dimensions in inches (mm)

Tolerance ±0.005 (0.13) for three decimal places
 ±0.01 (0.3) for two decimal places
 unless otherwise specified

CAUTION

Solder pins individually with heat application not exceeding 300°C for 10 seconds per pin.

Materials

Header Kovar/Nickel/Gold
 Cover Kovar/Nickel
 Pins Kovar/Nickel/Gold matched glass seal
 Gold plating of 50 - 225 microinches
 included in pin diameter
 Seal hole: 0.056 ± 0.001 (1.42 ± 0.03)

Case A2, Rev G, 2013.05.07

Please refer to the numerical dimensions for accuracy.

FIGURE 22: CASE A2

SLH Single and Dual DC-DC Converters

28 VOLT INPUT – 1.5 WATT

ELEMENT EVALUATION SPACE DC-DC CONVERTERS PROTOTYPE, CLASS H AND CLASS K

COMPONENT-LEVEL TEST PERFORMED	NON-QML ¹	QML			
	PROTOTYPE	CLASS H		CLASS K	
	/O	/H		/K	
	M/S ²	M/S ²	P ³	M/S ²	P ³
Element Electrical	■	■	■	■	■
Visual		■	■	■	■
Internal Visual		■		■	
Temperature Cycling				■	■
Constant Acceleration				■	■
Interim Electrical				■	
Burn-in				■	
Post Burn-in Electrical				■	
Steady State Life				■	
Voltage Conditioning Aging					■
Visual Inspection					■
Final Electrical		■	■	■	■
Wire Bond Evaluation		■	■	■	■
SEM				■	

Notes

1. Non-QML products may not meet all of the requirements of MIL-PRF-38534.
2. M/S = Active components (microcircuit and semiconductor die)
3. P = Passive components, Class H and K element evaluation. Not applicable to space prototype ("O") element evaluation.

Definitions:

Element Evaluation: Component testing/screening per MIL-STD-883 as determined by MIL-PRF-38534
SEM: scanning electron microscopy

TABLE 8: ELEMENT EVALUATION

SLH Single and Dual DC-DC Converters

28 VOLT INPUT – 1.5 WATT

ENVIRONMENTAL SCREENING SPACE DC-DC CONVERTERS PROTOTYPE, CLASS H AND CLASS K, RHA ¹ L AND R

TEST PERFORMED	NON-QML ²	QML ³					
	PROTOTYPE	CLASS H			CLASS K		
	/OO ⁴	/HP	/HL	/HR	/KP	/KL	/KR
Non-destruct wire bond pull, Method 2023		■ ⁵	■ ⁵	■ ⁵	■	■	■
Pre-cap Inspection, Method 2017, 2032	■	■	■	■	■	■	■
Temperature Cycle (10 times) (Qual 100 times) Method 1010, Cond. C, -65°C to +150°C, ambient	■	■	■	■	■	■	■
Constant Acceleration Method 2001, 3000 g (Qual 5000 g)	■	■	■	■	■	■	■
PIND, Test Method 2020, Cond. A		■ ⁵	■ ⁵	■ ⁵	■	■	■
Pre burn-in test, Group A, Subgroups 1 and 4	■	■ ⁵	■ ⁵	■ ⁵	■	■	■
Burn-in Method 1015, +125°C case, typical ⁶							
96 hours	■						
160 hours		■	■	■			
2 x 160 hours (includes mid-BI test)					■	■	■
Final Electrical Test, MIL-PRF-38534, Group A,							
Subgroups 1 and 4: +25°C case	■						
Subgroups 1 through 6, -55°C, +25°C, +125°C case		■	■	■	■	■	■
Hermeticity Test, Method 1014							
Gross Leak, Cond. B ₂ , Kr85					■	■	■
Gross Leak, Cond. C ₁ , fluorocarbon	■	■	■	■			
Fine Leak, Cond. B ₁ , Kr85					■	■	■
Fine Leak, Cond. A ₂ , helium	■	■	■	■			
Radiography, Method 2012					■	■	■
Post Radiography Electrical Test, +25°C case					■ ⁵	■ ⁵	■ ⁵
Final visual inspection, Method 2009	■	■	■	■	■	■	■
RHA L: 50 krad(Si) total dose ^{1, 7}			■			■	
RHA R: 100 krad(Si) total dose ^{1, 7}				■			■
SEE, LET 86 MeV cm²/mg ^{1, 8}		■	■	■	■	■	■

Test methods are referenced to MIL-STD-883 as determined by MIL-PRF-38534.

Notes

- 1. Our Redmond facility has a DLA approved RHA plan for Interpoint power products. Our SMD products with RHA "L" or "R" code meet DLA requirements.
- 2. Non-QML prototype products may not meet all of the requirements of MIL-PRF-38534.
- 3. All processes are QML qualified and performed by certified operators.
- 4. "O" in the RHA designator position in Interpoint model numbers indicates DLA RHA "-" defined as no RHA.
- 5. Not required by DLA but performed to assure product quality.
- 6. Burn-in temperature designed to bring the case temperature to +125°C minimum. Burn-in is a powered test.
- 7. High dose rate test.
- 8. No destructive events or SEL.

TABLE 9: ENVIRONMENTAL SCREENING AND RHA LEVELS

