

### 描述 / Descriptions

TO-92 塑封封装单向可控硅。Thyristor in a TO-92 Plastic Package.

### 特征 / Features

较低的通态压降，灵敏一致的触发特性，可靠性高。

Lower on state voltage drop,Sensitive and consistent trigger characteristics,High reliability.

### 用途 / Applications

广泛应用于各种脉冲点火器，负离子发生器，小型马达控制器，漏电保护器等线路功率控制。

Used in pulse ignition devices, negative ion generator,small motor controller,leakage protection and other circuit power control.

### 内部等效电路 / Equivalent Circuit

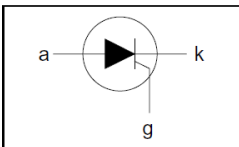

### 引脚排列 / Pinning



PIN1 : Anode      PIN 2 : Gate      PIN 3 : Cathode

### 放大及印章代码 / $h_{FE}$ Classifications & Marking

见印章说明。See Marking Instructions.

**极限参数 / Absolute Maximum Ratings(Ta=25°C)**

参数 Parameter	符号 Symbol	测试条件 Test Conditions	数值 Rating	单位 Unit
Repetitive peak off-state voltages	V <sub>DRM</sub>	T <sub>j</sub> =-40 to 110°C, Sine Wave, 50 to 60Hz, Gate Open	600	V
	V <sub>R<sub>RRM</sub></sub>			
RMS on-state current (Tc=80°C)	I <sub>T(RMS)</sub>	180° Conduction Angles	0.8	A
Non-repetitive peak on-state current	I <sub>TSM</sub>	1/2 Cycle, Sine Wave, 60Hz, T <sub>j</sub> =25°C	10	A
I <sup>2</sup> <sub>t</sub> for fusing	I <sup>2</sup> t	t=8.3ms	0.415	A <sup>2</sup> S
Peak gate power	P <sub>GM</sub>	T <sub>A</sub> =25°C, Pulse Width≤1.0μs	100	mW
Peak Average power	P <sub>G(AV)</sub>	T <sub>A</sub> =25°C, t=8.3ms	100	mW
Peak gate current	I <sub>GM</sub>	T <sub>A</sub> =25°C, Pulse Width≤1.0μs	1.0	A
Peak Reverse Gate Voltage	V <sub>RGM</sub>	T <sub>A</sub> =25°C, Pulse Width≤1.0μs	5.0	V
Junction Temperature	T <sub>j</sub>		-40~125	°C
Storage Temperature Range	T <sub>stg</sub>		-40~150	°C

**电性能参数 / Electrical Characteristics(Ta=25°C)**

参数 Parameter	符号 Symbol	测试条件 Test Conditions	最小值 Min	典型值 Typ	最大值 Max	单位 Unit
Repetitive peak off-state current	I <sub>DRM</sub> , I <sub>R<sub>RRM</sub></sub>	V <sub>D</sub> =Rated V <sub>DRM</sub> and V <sub>R<sub>RRM</sub></sub> R <sub>GK</sub> =1KΩ	T <sub>j</sub> =25°C		10	μA
			T <sub>j</sub> =125°C		100	
On-state voltage	V <sub>TM</sub>	I <sub>TM</sub> =1.0A, tp=380us			1.35	V
Gate trigger current	I <sub>GT</sub>	V <sub>D</sub> =12V, R <sub>L</sub> =100Ω			50	μA
Holding current	I <sub>H</sub>	I <sub>T</sub> =50mA, R <sub>GK</sub> =1KΩ	T <sub>j</sub> =25°C		5	mA
			T <sub>j</sub> =-40°C		10	
Latch Current	I <sub>L</sub>	I <sub>G</sub> =1mA, R <sub>GK</sub> =1KΩ	T <sub>j</sub> =25°C		10	mA
			T <sub>j</sub> =-40°C		15	
Gate trigger voltage	V <sub>GT</sub>	V <sub>D</sub> =12V, R <sub>L</sub> =100Ω	T <sub>j</sub> =25°C		0.8	V
			T <sub>j</sub> =-40°C		1.2	
Off-state leakage current	V <sub>GD</sub>	V <sub>D</sub> =1/2V <sub>DRM</sub>	0.2			V
Forward Voltage Application Rate	dv/dt	V <sub>D</sub> =67% V <sub>DRM</sub> R <sub>GK</sub> =1KΩ T <sub>j</sub> =125°C	20			V/us

**电参数曲线图 / Electrical Characteristic Curve**

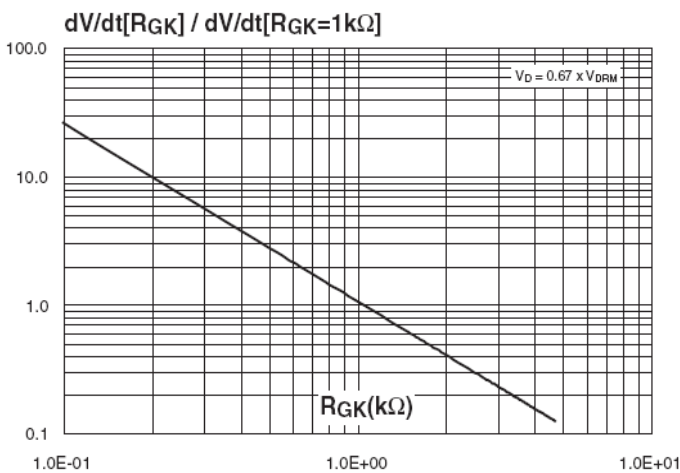
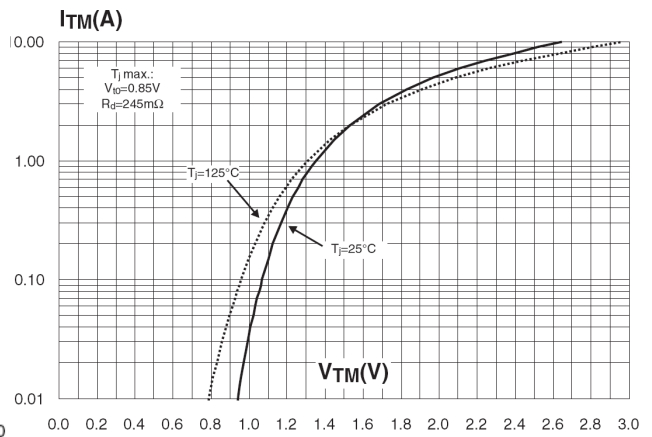
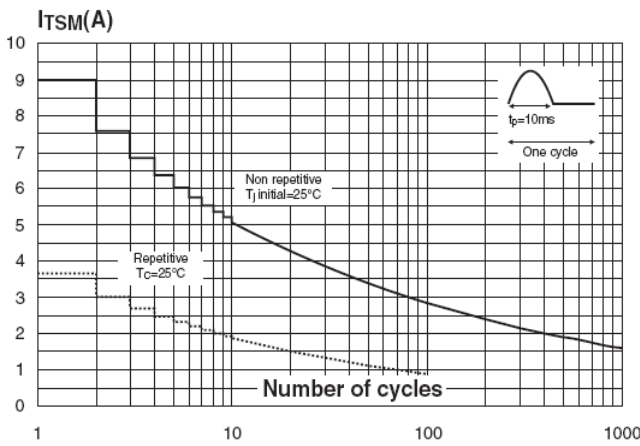
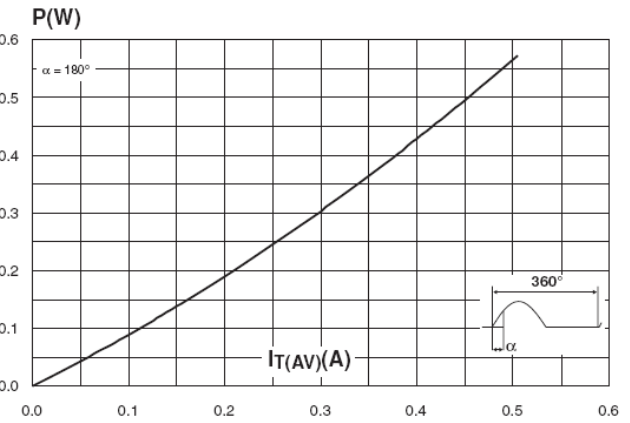
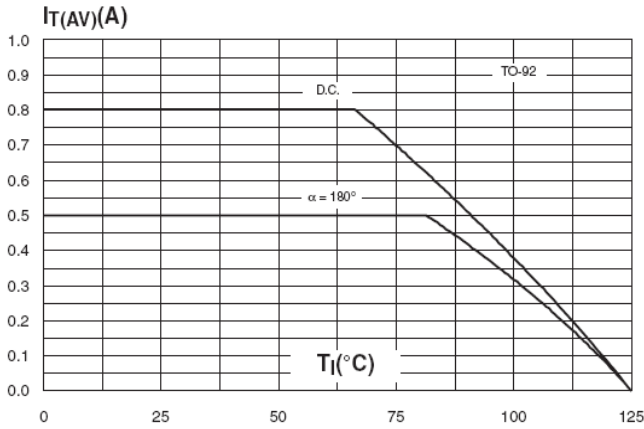

外形尺寸图 / Package Dimensions

T0-92

Unit: mm

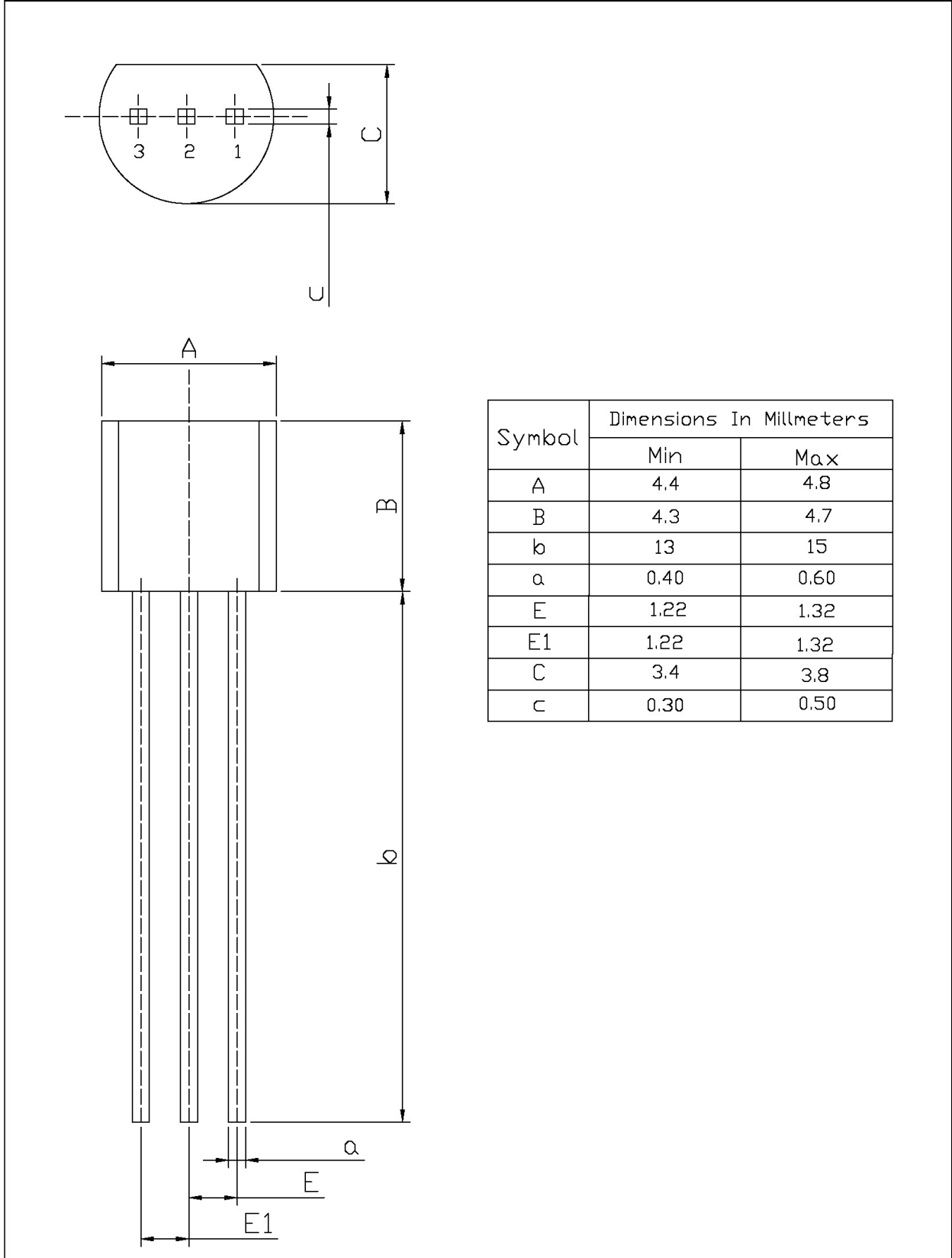

**印章说明 / Marking Instructions**

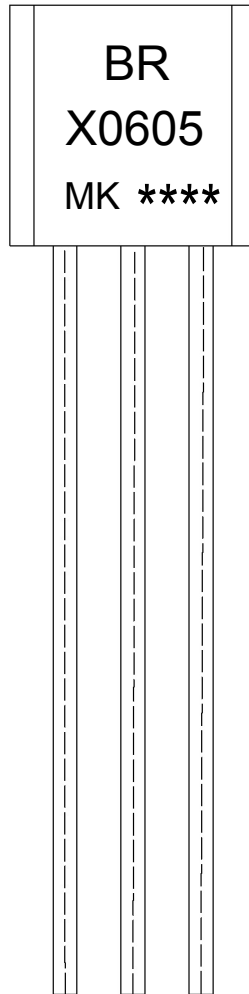

说明：

BR： 为公司代码

X0605 MK：为产品型号

\*\*\*\*： 为生产批号代码，随生产批号变化。

Note:

BR: Company Code.

X0605 MK: Product Type.

\*\*\*\*: Lot No. Code, code change with Lot No.

**波峰焊温度曲线图(无铅) / Temperature Profile for Dip Soldering(Pb-Free)**



说明：

- 1、预热温度 25 ~ 150°C，时间 60 ~ 90sec;
- 2、峰值温度 255±5°C，时间持续为 5±0.5sec;
- 3、焊接制程冷却速度为 2 ~ 10°C/sec.

Note:

- 1.Preheating:25~150°C, Time:60~90sec.
- 2.Peak Temp.:255±5°C, Duration:5±0.5sec.
3. Cooling Speed: 2~10°C/sec.

**耐焊接热试验条件 / Resistance to Soldering Heat Test Conditions**

温度：270±5°C

时间：10±1 sec.

Temp.:270±5°C

Time:10±1 sec

**包装规格 / Packaging SPEC.**

散件包装 / BULK

Package Type 封装形式	Units 包装数量					Dimension 包装尺寸 (unit: mm3)		
	Units/Bag 只/袋	Bags/Inner Box 袋/盒	Units/Inner Box 只/盒	Inner Boxes/Outer Box 盒/箱	Units/Outer Box 只/箱	Bag 袋	Inner Box 盒	Outer Box 箱
TO-92	1,000	10	10,000	5	50,000	135×190	237×172×102	560×245×195
	1,000	10	10,000	10	100,000	135×190	237×172×102	560×245×375

编带包装 / AMMO

Package Type 封装形式	Units 包装数量					Dimension 包装尺寸 (unit: mm3)	
	Units/tape 只/纸带	Tape/Inner Box 纸带/盒	Rows/Inner Box 纸带层/盒	Inner Boxes/Outer Box 盒/箱	Units/Outer Box 只/箱	Inner Box 盒	Outer Box 箱
TO-92	3,000	1	120	10	30,000	328×230×42	小箱 480×346×235, 大箱 547×407×268

**使用说明 / Notices**