

# LUXEON F

## Assembly and Handling Information

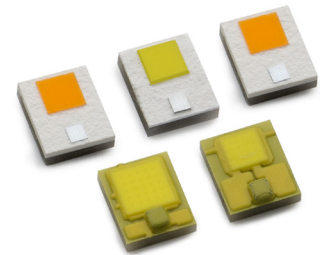

### Introduction

This Application Brief covers recommended assembly and handling procedures for the LUXEON F family of emitters. LUXEON F family of emitters are designed to deliver high luminous flux and efficacy in an easy-to-assemble SMD package that facilitates assembly in automotive exterior lighting applications. Proper assembly, handling, and thermal management, as outlined in this Application Brief, ensure high optical output and long LED lumen maintenance for LUXEON F.

### Scope

The assembly and handling guidelines in this Application Brief apply to the following products:

- 
- LUXEON F (LFXH-x1A, LFMH-x1A)
  - LUXEON F ES (LFXH-C2B)
  - LUXEON F Plus (LFXH-x1C, LFMH-x1C)
  - LUXEON F Premium (LFXH-C1D)
- 

Any assembly or handling requirements that are specific to a subset of LUXEON F products is clearly marked. In the remainder of this document the term LUXEON F refers to any product in the LUXEON F product family.

# Table of Contents

Introduction	1
Scope	1
<b>1. Component</b>	<b>3</b>
1.1 Reference Document	3
1.2 Description	3
1.3 Form Factor	4
1.4 Optical Center	4
1.5 Handling Precautions	5
1.6 Cleaning	6
1.7 Electrical Isolation	7
1.8 Mechanical Files	7
<b>2. Printed Circuit Board</b>	<b>7</b>
2.1 PCB Requirements	7
2.2 Footprint and Land Pattern	7
2.3 Thermal Resistance	8
2.4 Surface Finishing	9
2.5 Close Proximity Placement	9
<b>3. Insulated Metal Substrate</b>	<b>10</b>
3.1 Thermal Concepts	10
<b>4. FR4-Based Board</b>	<b>10</b>
4.1 Material Properties	10
4.2 Thermal Via Concept	10
4.3 Close Component Spacing	12
<b>5. Thermal Management</b>	<b>13</b>
5.1 Thermal Measurement Guidance	13
<b>6. Assembly Process Recommendations and Parameters</b>	<b>14</b>
6.1 Stencil Design	14
6.2 Solder Paste	15
6.3 Pick and Place	15
6.4 Pick and Place Machine Optimization	21
6.5 Placement Accuracy	22
6.6 Reflow Profile	22
6.7 Reflow Accuracy	24
6.8 Void Inspection	24
6.9 FR4 Board Handling	25
6.10 Flexible Circuit Board Handling	26
<b>7. JEDEC Moisture Sensitivity Level</b>	<b>26</b>
<b>8. Product Packaging Consideration—Chemical Compatibility</b>	<b>27</b>
About Lumileds	29

# 1. Component

## 1.1 Reference Document

The LUXEON F datasheet is available upon request. Please contact your sales representative.

## 1.2 Description

LUXEON F emitters consist of a LED chip mounted onto a ceramic substrate. This substrate provides mechanical support and thermally connects the LED chip to a thermal pad on the bottom of the substrate. An electrical interconnect layer connects the LED chip to a cathode and anode on the bottom of the ceramic substrate. The LED and the topside of the substrate are coated with silicone to shield the chip from the environment. LUXEON F emitters include a transient voltage suppressor (TVS) chip to protect the emitter against electrostatic discharges (ESD). See Figure 1.

Table 1. LUXEON F Product Description.

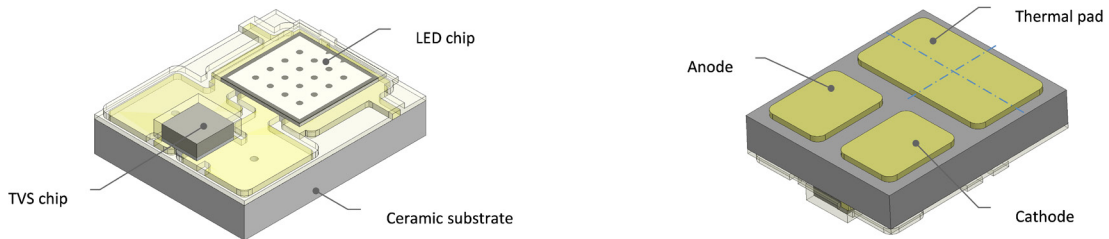

Figure 1. Layout of LUXEON F.

PRODUCT	COLOR	PART NUMBER	NOMINAL DRIVE CURRENT	DIE SIZE	TOP SIDE COATING	OFFSET OPTICAL: THERMAL PAD CENTER
 LUXEON F	Cool White	LFXH-C1A LFMH-C1A	350mA	1mm <sup>2</sup>	Soft	75µm
 LUXEON F	PC Amber	LFXH-L1A LFMH-L1A	350mA	1mm <sup>2</sup>	Hard	75µm
 LUXEON F ES	Cool White	LFXH-C2B	700mA	2mm <sup>2</sup>	Soft	275µm
 LUXEON F Plus	Cool White	LFXH-C1C LFMH-C1C	1000mA	1mm <sup>2</sup>	Hard	75µm
 LUXEON F Plus	PC Amber	LFXH-L1C LFMH-L1C	1000mA	1mm <sup>2</sup>	Hard	75µm
 LUXEON F Premium	Cool White	LFXH-C1D	1000mA	1mm <sup>2</sup>	Hard	75µm

### 1.3 Form Factor

LUXEON F comes in two different top side topologies as mentioned in Table 1. See the LUXEON F datasheet for the applicable top side dimensions.

### 1.4 Optical Center

LUXEON F has no lens (primary optics). The optical center is at the center location of the LED chip. LUXEON F comes in two die sizes (see Table 1) with different optical centers as indicated by the red dot in Figure 2. See the LUXEON F datasheet for the applicable tolerances.

Optical rayset data of each LUXEON F part is available upon request.

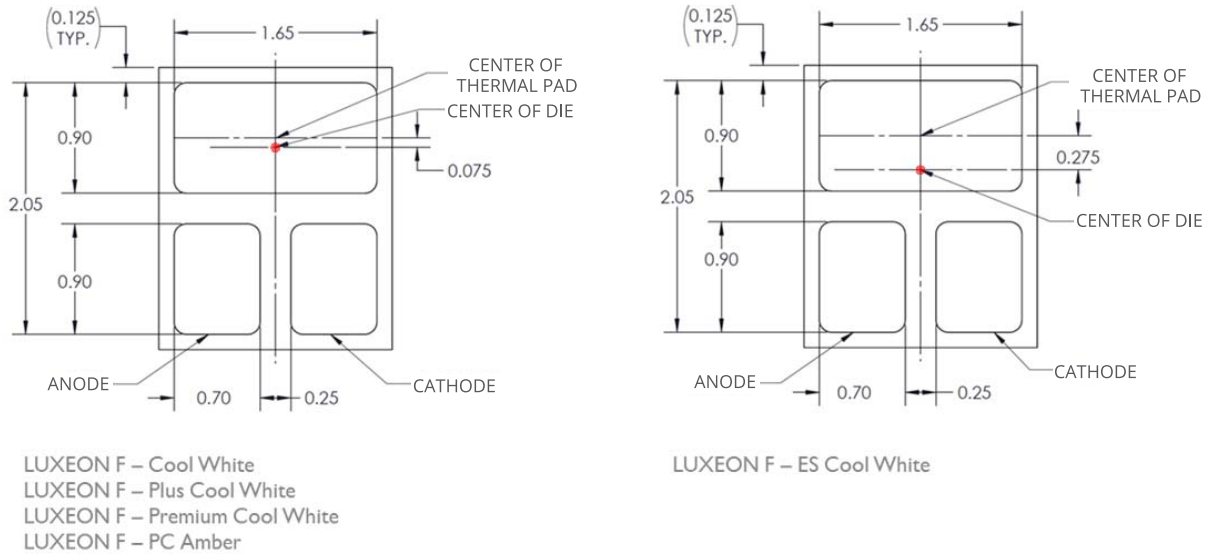

**LUXEON F, LUXEON F Plus, LUXEON F Premium**

**LUXEON F ES**

Figure 2. Theoretical optical center LUXEON F.

## 1.5 Handling Precautions

Like all electrical components, there are handling precautions that need to be taken into account when setting up assembly procedures. The following cautions are noted for LUXEON F:

1. Electrostatic Discharge (ESD) protection — Electrostatic Discharges, rapid transfers of charges between two bodies due to an electrical potential difference between those bodies, can cause unseen damage to electronic components. In LED devices, ESD events can result in a slow degradation of light output and/or early catastrophic failures. In order to prevent ESDs from causing any damage, Lumileds devices include a Transient Voltage Suppressor (TVS) chip. This TVS chip breaks down under high voltages, providing a current path in parallel with the LED chip (see Figure 3.)

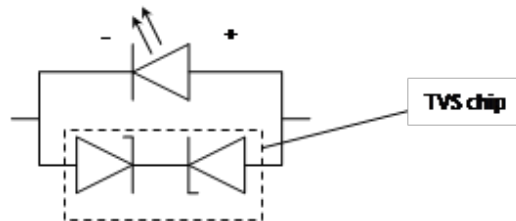

Figure 3. Electrical schematic.

Common causes of ESD include the direct transfer of charges from the human body or from a charged conductive object to the LED component. In order to test the susceptibility of LEDs to these common causes of ESDs, two different models are typically used:

- Human Body Model (HBM)
- Machine Model (MM)

Lumileds strongly recommends that customers adopt handling precautions for LEDs similar to those which are commonly used for other electronic surface mount components which are susceptible to ESD events. LUXEON F emitters have been independently verified to successfully pass ESD tests for both HBM and MM at the highest AEC recommended test voltages of +/- 8000V and +/- 400V, respectively. Nevertheless, Lumileds strongly recommends that customers adopt handling precautions for LEDs similar to those which are commonly used for other electronic surface mount components which are susceptible to ESD events.

Additional external ESD protection for the LED may be needed if the LED is used in non ESD-protected environments and/or exposed to higher ESD voltages and discharge energy, e.g. as described in ISO 10605 or IEC 61000-4-2 (severity level IV). For details please contact your sales representative.

2. Minimize all mechanical forces exerted onto the silicone overcoat layer of LUXEON F.
  - For manual handling with tweezers, always pick up from the sides of the ceramic substrate and never from the sides of the silicone overcoat. An "L" shaped tweezers (e.g. Knipex precision tweezers 923229) with the pointed tip in parallel to the LED's ceramics is more appropriate and easier to use than "straight" tweezers. To reduce the chance of any damage to the LED part and provide stability during pick up and manual placement on the board, it is recommended that the thickness height of the tweezers tip and the thickness of the ceramic sides are the same (0.4mm) as shown in Figure 4.
  - In order to avoid any mechanical damage to the LED, do not apply more than 5N of shear force (500g-f) for the following products: LUXEON F, PC Amber, LUXEON F Plus and LUXEON Premium.
  - For LUXEON F, Cool White and LUXEON F ES, the maximum allowable applied shear force is 0.8N (80 g-f) for the lamination phosphor. However, it is extremely difficult to shear off only the lamination phosphor layer on LUXEON F, Cool White and LUXEON F ES, since this layer is very thin compared to the AlN substrate thickness. The flexural strength of AlN is 320MPa.
  - When utilizing a pick and place machine, always ensure that the pick and place nozzle does not place excessive pressure onto the LED. For more information see section 6.3 Pick and Place Nozzle of this document. Similar restrictions exist for manual handling.

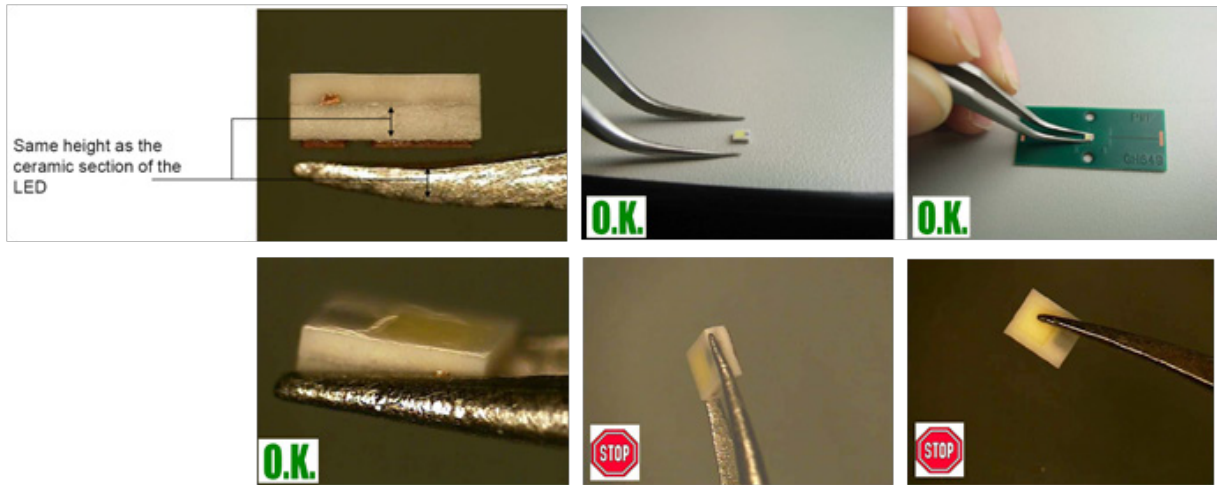

Figure 4. Tweezers handling.

- Alternatively, a vacuum pen can be used instead of tweezers. The suction tip should be made of a soft material such as rubber to minimize the mechanical force exerted onto the top surface of the silicone overcoat layer. Care should be taken to avoid the soft material from contaminating the top side surface of the LED. Suction on pen should be set such that pen does not cause indentation to coating of LUXEON F CW and CW ES coatings.
- Do not touch the top surface with fingers or apply any pressure to it when handling finished boards containing LUXEON F. In addition, do not put any boards with LUXEON F emitters top side down on a surface for probing. The surface of a workstation may be rough or contaminated and may damage the silicone overcoat layer. Any pressure applied during probing may potentially damage this layer (See Figure 5).

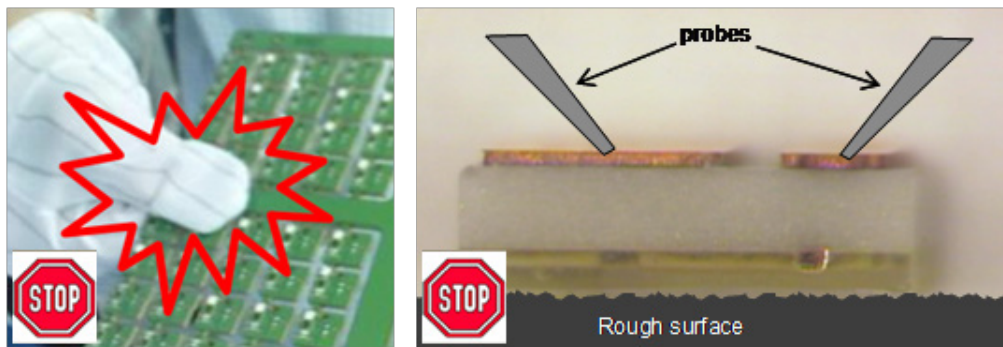

Figure 5. Board handling.

## 1.6 Cleaning

The surface of the LUXEON F emitters should not be exposed to dust and debris. Excessive dust and debris on the LED chip array may cause a decrease in optical output. It is best to keep LUXEON F emitters in their original shipping reel until actual use.

In the event that the surface requires cleaning, a compressed gas duster or an air gun with 1.4bar (at the nozzle tip) at a distance of 15cm will be sufficient to remove the dust and debris. Make sure the parts are secured first.

One can also use a lint-free swab and optional isopropyl alcohol (IPA) to gently swab the surface. Do not use solvents that are listed in Table 5 as they may adversely react with the LED assembly. Extra care should be taken not to damage the white silicone coating around the LED chips. Always verify that there are no large particles or debris left on the surface before swabbing.

## 1.7 Electrical Isolation

The thermal pad of LUXEON F is electrically isolated from the LED. There is an exposed electrical trace (cathode) on two sides of the LED package as shown in Figure 6. LEDs cannot be placed too close to each other. During reflow they may get in contact with each other, causing potential arcing.

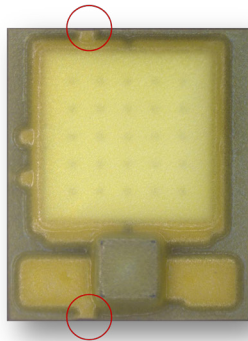

Figure 6a. Exposed traces of LUXEON F ES, LUXEON F, LUXEON F Plus.

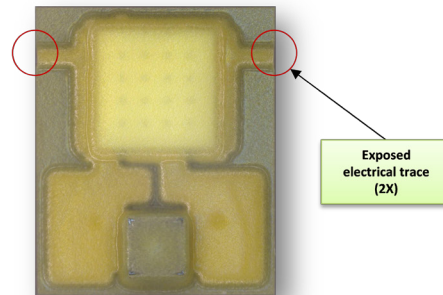

Figure 6b: Exposed traces of LUXEON F Premium.

## 1.8 Mechanical Files

Mechanical drawings for LUXEON F (2D and 3D) are available upon request. For details please contact your sales representative.

# 2. Printed Circuit Board

## 2.1 PCB Requirements

The LUXEON F can be mounted on a multi-layer FR4 PCB (Printed Circuit Board) or an IMS (Insulated Metal Substrate). To ensure optimal operation of the LUXEON F, the thermal path between the LED package and the heat sink should have a thermal resistance as low as feasible.

Historically, IMS has been used for its low thermal resistance and rigidity. However, IMS is not always the most economical solution for certain applications. A two layer FR4 board (with filled and capped vias), in contrast, often offers a much lower cost solution for a thermally efficient package.

For reference, here are the applicable IPC standards when designing PCB boards.

- General PCB design:
  - IPC A-610D: Acceptability of Electronic Assemblies
- Filled and capped via boards:
  - IPC 4761: Design Guide for Protection of Printed Board Via Structures
  - IPC 2315: Design Guide for High Density Interconnects and Micro Vias
  - IPC 2226: Design Standard for High Density Interconnect Printed Boards

## 2.2 Footprint and Land Pattern

Lumileds has conducted an investigation to find the optimal design of the LUXEON F land pattern on a PCB. The goal of this study was to create a board with low thermal resistance, high placement accuracy and a minimum number of solder voids.

The PCB designs, as discussed in this document, are based on several board design rules and are a balance between performance and overall cost. Ultimately, it is the customer's responsibility to determine the final design.

Figure 7 shows a recommended standard pad layout. The green solder mask is a photolithographic mask, which offers a highly accurate alignment to the copper layer. This layout is applicable for the different PCB configurations as mentioned in this document.

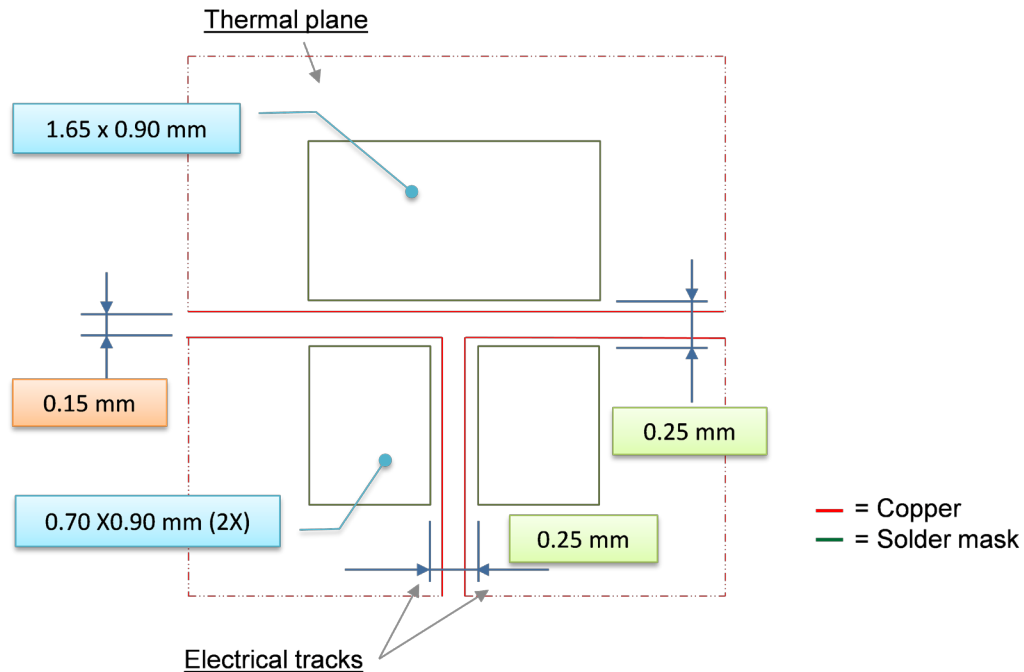

Figure 7. Recommended standard layout.

Practical test points should be placed for the anode and cathode of each LED, to allow testing of each individual LED.

## 2.3 Thermal Resistance

The thermal resistance between the component case (body) and the back of the PCB ( $R\theta_{c-pcb}$ ) depends on the size of Cu area around the thermal pad, the number of vias, placement of the vias, the Cu plating thicknesses and PCB thickness.

### Effect of thermal vias:

An FR4 board with no thermal vias will have the highest thermal resistance. Adding thermal vias will reduce the thermal resistance but may increase the FR4 board cost. At some point, the additional thermal vias added will only marginally improve the thermal resistance. The copper area around the electrodes has a significant contribution to the thermal spreading.

Figure 8 shows the simulation data for the thermal resistance of junction-to-PCB ( $R_{th_{j-pcb}}$ ) of a 1.5mm thick FR4 board with:

- 70µm thick top and bottom copper plating and 25µm thick copper plating inside the via hole.
- 0.5mm open vias holes or 0.2mm filled and capped vias holes.
- 20µm thick top and bottom solder resist layer.
- 20µm thick top solder resist and no bottom resist layer in case of no vias in electrical pads/traces.



The anode and cathode pads contribute significantly to the heat dissipation from the die to the board. We recommend having an equal distribution of thermal vias between thermal pad and electrical pads (anode plus cathode).

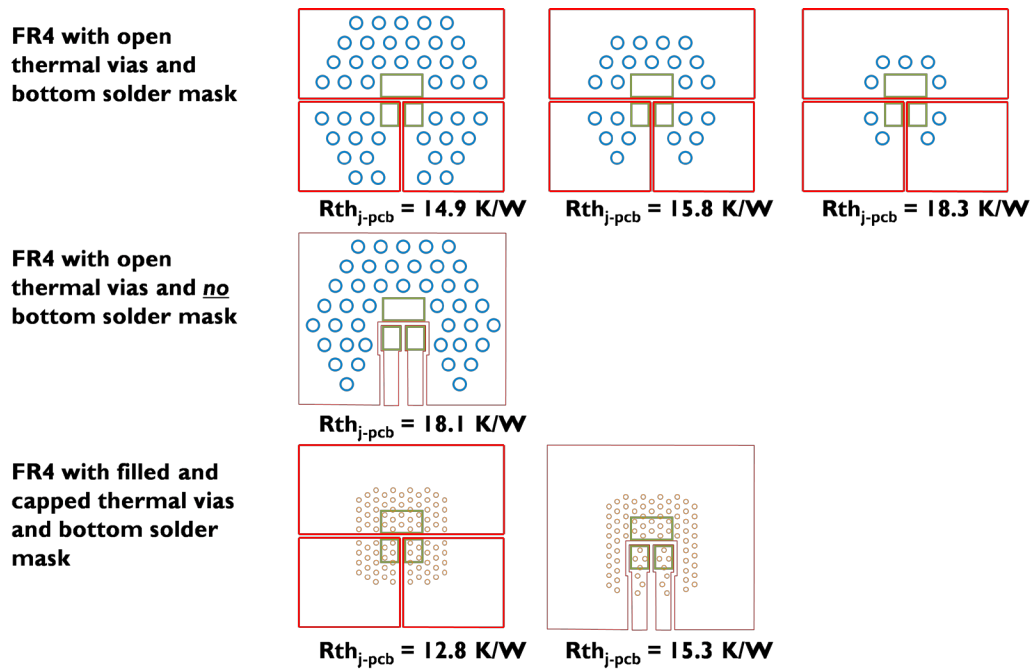

Figure 8. Simulated effects of thermal vias.

## 2.4 Surface Finishing

Lumileds recommends using ENIG (Ni flash Au) plating.

## 2.5 Close Proximity Placement

Lumileds recommends a minimum edge to edge spacing between the components of 0.3mm, see Figure 9. It needs to be noted that components may drift together during the solder step if the edge to edge spacing is too small. Please contact your sales representative in case your application needs a smaller spacing than 0.3mm.

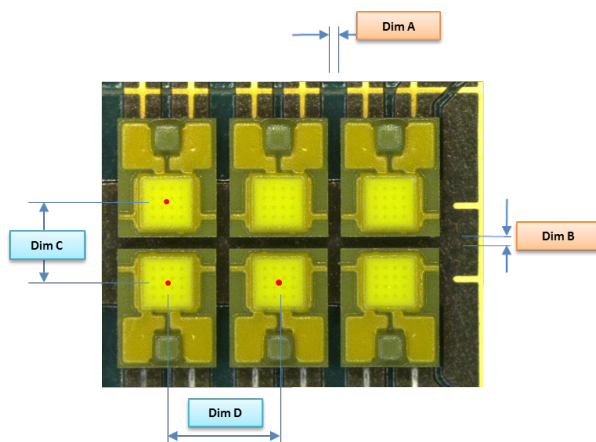

PRODUCT	DIM A (mm)	DIM B (mm)	DIM C (mm)	DIM D (mm)
LUXEON F	0.3	0.3	1.6	2.2
LUXEON F ES	0.3	0.3	2.0	2.2
LUXEON F Plus	0.3	0.3	1.6	2.2
LUXEON F Premium	0.3	0.3	1.6	2.2

Figure 9. Illustration of edge to edge spacing. The table summarizes typical dimensions assuming all LUXEON F emitters are placed at the minimum edge to edge spacing of 0.3mm.

### 3. Insulated Metal Substrate

Insulated Metal Substrate (IMS) boards have, dependent on their substrate material properties (Al or Cu based IMS), a mismatch in Coefficient of Thermal Expansion (CTE) with respect to the LED. CTE mismatch creates stress in the solder interface between LED and IMS during temperature cycling conditions. This stress can be partly compensated by the design of the IMS like dielectric material properties and thickness, and metallization layer thickness. Lumileds, therefore, recommends that customers contact their IMS vendors for suitable dielectric materials and qualify IMS boards per application.

#### 3.1 Thermal Concepts

The Insulated Metal Substrate IMS is a three layer system comprising a standard circuit layer, a special thin electrical isolation layer with a minimum thermal resistance (typical range 1.0–2.5 W/m<sup>2</sup>\*K) and a metal base layer that has the function of heat spreader. The most common metal base layer is an Aluminum sheet of 1.5mm thickness (See Figure 10).

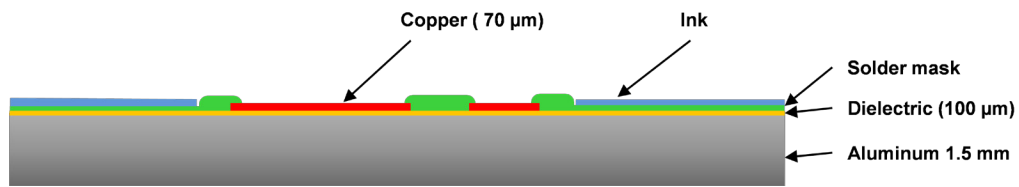

Figure 10. Cross section of Insulated Metal Substrate.

### 4. FR4-Based Board

#### 4.1 Material Properties

FR4 is an industry standard PCB technology. Depending on the LED application, drive condition and the number of LEDs on the board, the choice for T<sub>g</sub> (Glass Transition Temperature) and CTI (Comparative Tracking Index) value of the base material needs to be set. Most common FR4 materials have T<sub>g</sub>=150°C and CTI=175V. For high operating temperatures and voltage applications, the T<sub>g</sub> value, trace clearances and CTI values may be increased accordingly.

#### 4.2 Thermal Via Concept

Thermal vias are the primary method of heat transportation to the heat sink at the PCB bottom. A thermal via is a plated through hole that can be open, filled (plugged) or filled and capped. Lumileds conducted a thermal simulation study on the “open” and “filled and capped” via design aimed at reducing the thermal resistance.

##### Board Design

A cross section of this design for a standard two layer board with thermal vias is shown in Figures 11 and 12. The final thermal resistance is determined by the number and density of vias, the copper plating thickness, PTH thickness and the plugging material used to fill the vias. See also Figure 8.

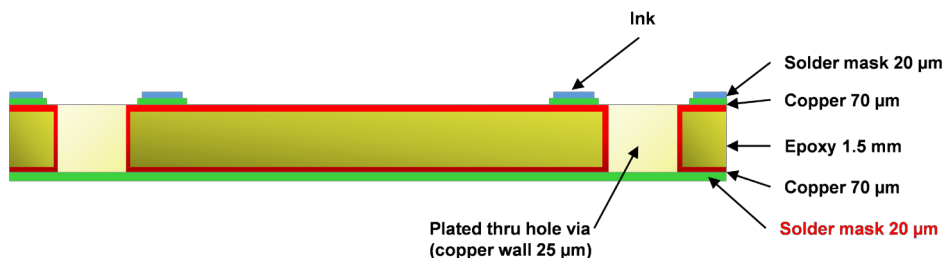

Figure 11. Cross section of FR4 based PCB with open thermal vias.

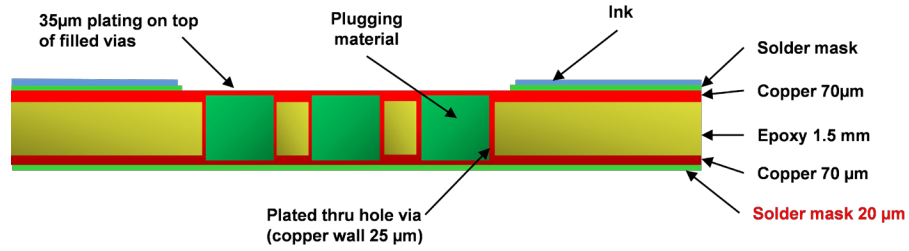

Figure 12. Cross section of FR4 based PCB with filled and capped thermal vias.

## Thermal Via Design

### Open Via

Figure 13 indicates a typical open via design. The diameter of the hole of the open via is 0.5mm. The recommended pitch between two holes is 0.9mm. The copper plane should extend the via area for minimal 0.5mm all around.

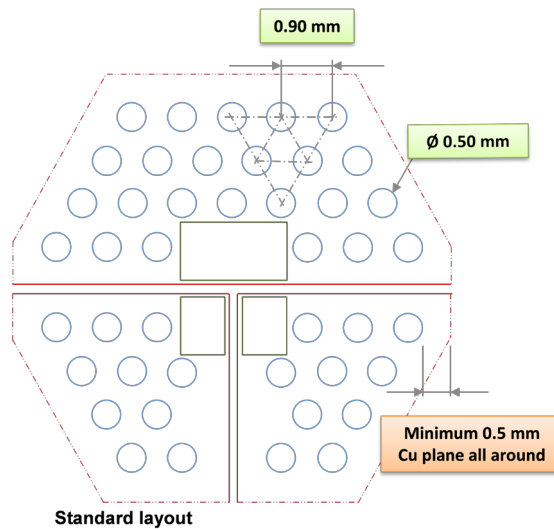

Figure 13. Typical open via design.

### Filled and Capped Via

Figure 14 indicates a typical filled and capped via design. The diameter of the hole of the via is 0.2mm. The recommended pitch between two holes is 0.4mm. The copper plane should extend the via area for minimal 0.2mm all around.

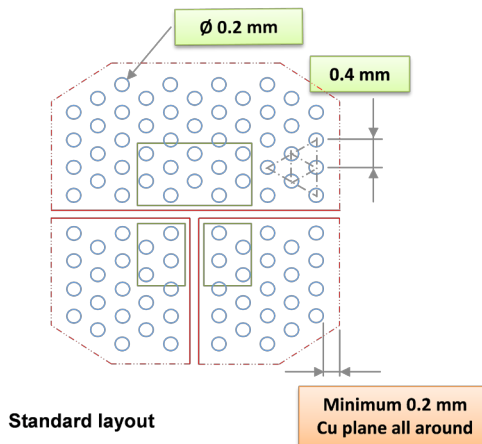

Figure 14. Typical filled and capped via design.

Each via is filled with an epoxy material. Standard industry practices recommend using a plugging material with a CTE (Coefficient of Thermal Expansion) and  $T_g$  to match the thermal characteristics of the PCB. Recommendations on qualification criteria for the plugging process are documented in IPC-4761 "Design Guide for Protection of Printed Board Via Structures." Use of a thermally improved plugging material can further reduce the board thermal resistance, although the absolute improvement will be small.

### 4.3 Close Component Spacing

The minimum edge to edge spacing between LUXEON F emitters is limited by the thermal performance of the vias layouts. In particular, if LUXEON F emitters are placed in close proximity to each other, the available space for thermal vias between neighboring emitters goes down, which has a negative effect on the overall thermal resistance of the board. Lumileds recommends for small component spacing using the Insulated Metal Substrate (IMS) design or FR4 with filled and capped vias design.

Figure 15 shows the simulated thermal resistance (see Figure 16 for definition of  $T_j$  and  $T_{hs}$ ) as a function of the spacing between neighboring LUXEON F emitters. The simulation model is designed in such way that the distance (gap) between 4 LEDs is equal in all directions. The board parameters are similar to Figure 10 (IMS) and Figure 12 (FR4 with filled and capped vias).

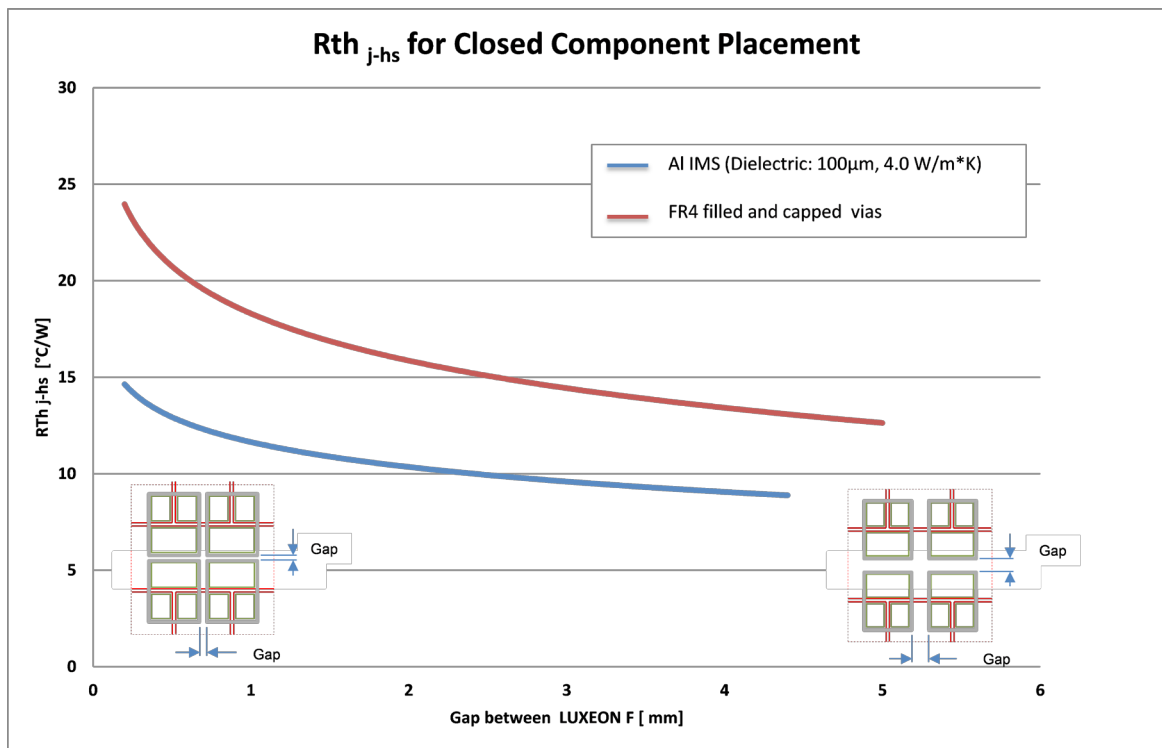

Figure 15. Simulated thermal resistance as function of gap.

# 5. Thermal Management

The reliability expectations, as mentioned in the LUXEON F datasheet, are based on case temperature ( $T_c$ ) and not LED junction temperature ( $T_j$ ). The case temperature is defined as the temperature at the center of the thermal pad, see also Figure 7.

## 5.1 Thermal Measurement Guidance

The use of a temperature probe may be desirable to verify the overall system design model & expected thermal performance. Depending on the required temperature measurement accuracy, different methods to determine  $T_c$  are possible as described in Table 2. The more accurate the measurement is, the closer  $T_c$  can be designed to the maximum allowable  $T_c$  temperature as specified in the LUXEON F datasheet. Figure 16 describes schematically the LED soldered to a PCB, including the relevant temperatures as defined for specific positions in the setup. Since the LED is directly soldered to the board, the case temperature  $T_c$  is equal to the temperature of the solder material  $T_{solder}$  at this position.

$$T_c = T_{solder} \text{ (at position below thermal pad of LED)}$$

Table 2. Temperature Measurement Methods

METHOD	ACCURACY (°C)	EFFORT	EQUIPMENT COST
Thermo sensor (e.g. thin wire thermocouple)	± 2.0	Low	Low
Forward Voltage Measurement	± 0.5	High	High

### Temperature Probing by Thermo Sensor

A practical way to verify the case temperature  $T_c$  is to measure the temperature  $T_{sensor}$  on a predefined sensor pad thermally close to the case by means of a thermocouple or a thermistor (see Figure 16.)

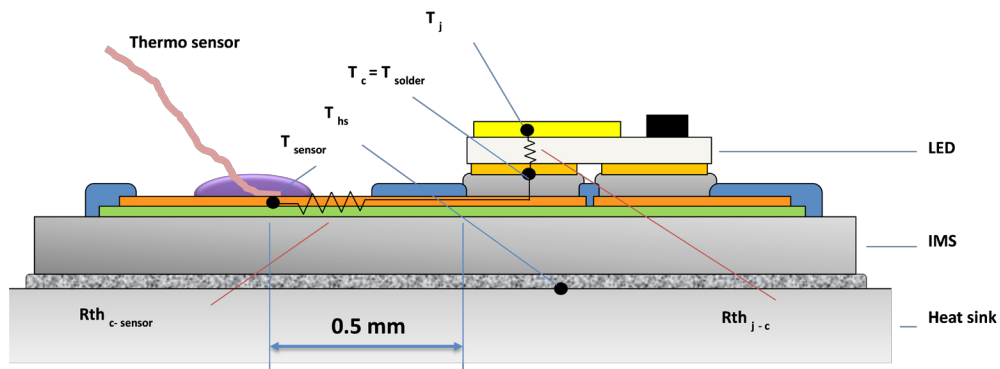

Figure 16. Temperature probing by thermo sensor (Schematically)

The  $T_c$  can be calculated according the following equation:

$$T_c = T_{sensor} + R_{th\ c-sensor} \cdot P_{electrical}$$

In this equation  $T_{sensor}$  is the sensor temperature at the predefined location and  $P_{electrical}$  is the electrical power going into the LUXEON F emitter.

The  $R_{th\ c-sensor}$  is application specific and can be determined with help of thermal simulations and measurements. The Lumileds Application Support team offers support to determine this value. Please contact your sales representatives. Lumileds has determined the typical  $R_{th\ c-sensor}$  for two different board concepts, see Table 3.

**Table 3. Typical  $R_{th\ c-sensor}$  Values Per Board**

BOARD CONCEPT	$R_{TH\ C-SENSOR}$ (0.5mm FROM TOP SIDE EDGE EMITTER)
Double layer FR4 with filled and capped vias	5 [K/W]
Aluminum based Insulated Metal Substrate	4 [K/W]

Please see the section “Board design” of this document for more detailed information regarding the design parameters.

### Temperature Measurement by Forward Voltage Measurement

The forward voltage measurement uses the temperature dependency of the LED’s forward voltage. The forward voltage change after switching off the thermally stabilized system is measured and analyzed. By using a thermal model of LUXEON F, the case temperature  $T_c$  can be calculated. To ensure high accuracy, a precise and fast Voltage Measurement System is needed. In addition, the relationship between forward voltage  $V_f$  and temperature needs to be properly characterized.

Please contact your sales representatives for further support in this topic.

## 6. Assembly Process Recommendations and Parameters

### 6.1 Stencil Design

The recommended solder stencil thickness is 125 $\mu$ m. If the area coverage of the solder paste is greater than 90% using lead-free solder, then a solder joint thickness of approximately 50 $\mu$ m is expected.

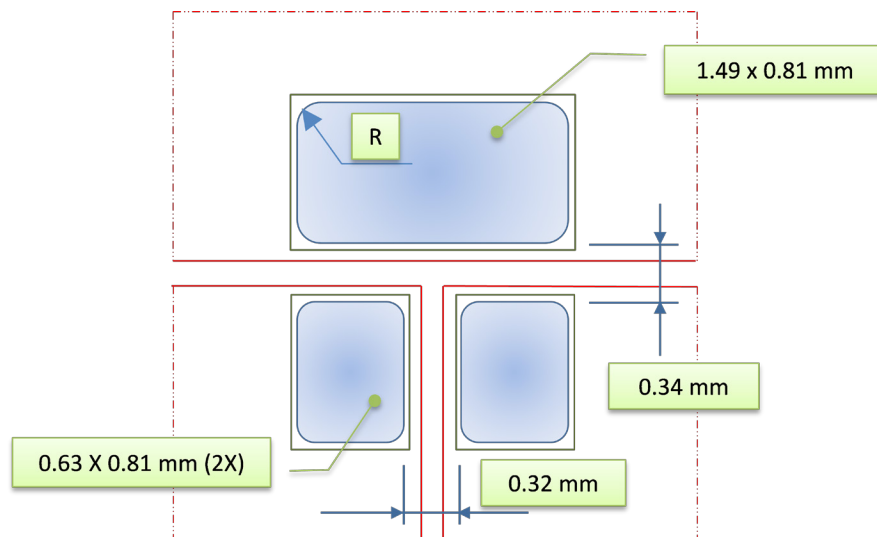

Figure 17. Stencil design for all the board designs.

## 6.2 Solder Paste

Lumileds recommends lead-free solder for the LUXEON F. Lumileds has tested the Hereaus F640-SAC305 and F640IL-89M30 with satisfactory results. However, since application environments vary widely, Lumileds recommends that customers perform their own solder paste evaluation in order to ensure it is suitable for the targeted application.

## 6.3 Pick and Place

The LUXEON F is packaged in a tape and reel with the light emitting surface facing upwards. Automated pick and place equipment provides the best handling and placement accuracy for LUXEON F emitters.

Lumileds recommends taking the following general pick and place guidelines into account:

- The pick-up areas are defined in Figure 18.
- The nozzle tip should be clean and free of any particles since this may interact with the top surface coating of the LUXEON F during pick and place.
- During setup and the first initial production runs, it is a good practice to inspect the top surface of LUXEON F emitters under a microscope to ensure that emitters are not accidentally damaged by the pick and place nozzle.

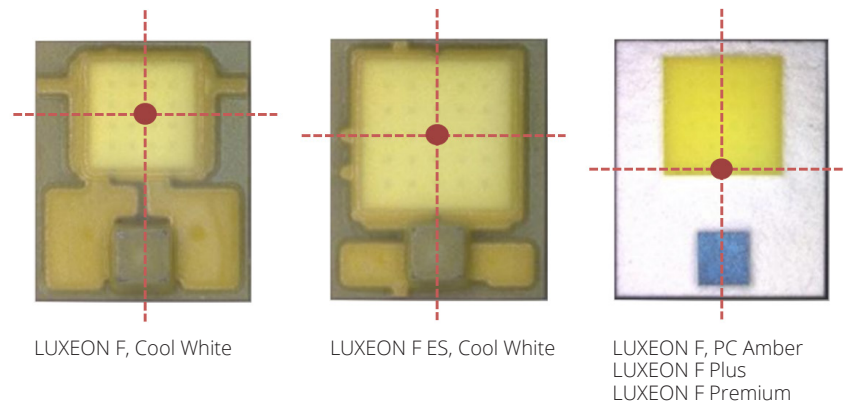

Figure 18. Pick-up area of LUXEON F.

Since LUXEON F has no primary optics or lens which can act as a mechanical enclosure protection for the LED chips, the pick-up and placement force applied to the top of the package should be kept well controlled.

**Equipment Platform:**

**ASM-SIPLACE with CPP Head**

Figure 19 shows the pick and place nozzle designs and the corresponding machine settings which have been successfully used to handle the LUXEON F emitters with the pick and place equipment of ASM-SIPLACE with CPP Head.

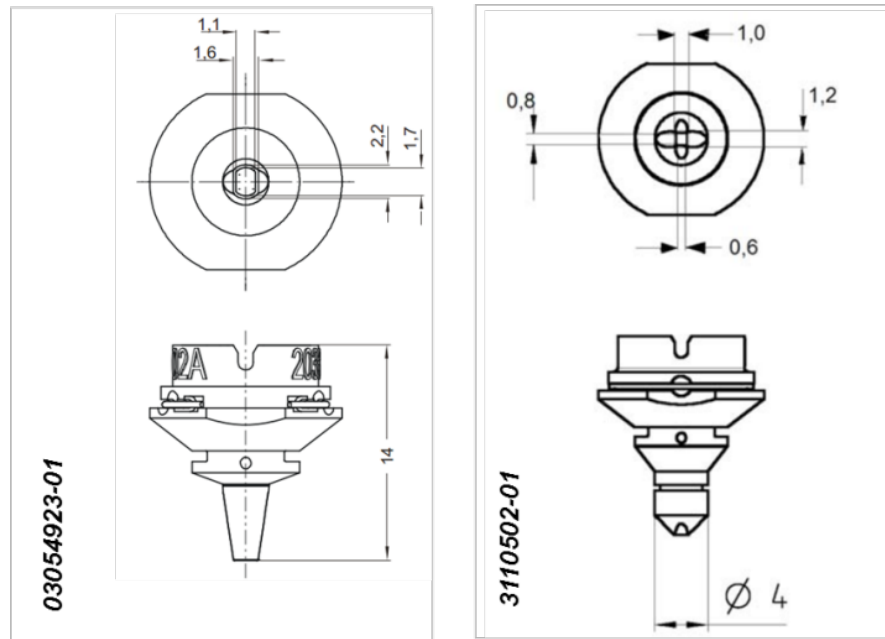

Figure 19. Nozzles of ASM-SIPLACE equipment with CPP head.

NOZZLE DATA	SIPLACE ITEM NUMBER	
	03054923-01	3110502-01
Group of Nozzle	20xx	20xx
Nozzle Form	rectangular	rectangular
Material: Housing /Tip	Vectra A230 / TPU ESD able	
Name	Nozzle Type 2033	Nozzle Type 2052
Measurements	A=2.2x1.6 a=1.7x1.1, L=14	A=1.2x1.0 a=0.8x0.6, L=15.3
<b>FOR PRODUCTS</b>		
	LUXEON F, PC Amber	LUXEON F, Cool White
	LUXEON F Plus	LUXEON F ES
	LUXEON F Premium	



PICK INFORMATION	
Automatic Pickup Correction	No
Pickup Point X	See figure 18
Pickup Point Y	0mm
Pickup Point Z	0mm
Mode	With Contact
Force	2N
Waiting Time	0ms
MTC Acceleration (Y)	1.5g
MTC Acceleration (Z)	0.8g
Travel Profile – Lower	Standard
Travel Profile – Raise	Standard
Check component presence	Yes
Switch Position	Normal Vacuum
Stop on Pickup Error	No

PLACE INFORMATION	
Waiting Time	0ms
Air Kiss – Placement	150mbar
Air Kiss – Return	150mbar
Travel Profile – Lower	Standard
Travel Profile – Raise	Standard
Check component presence	Normal
Placement Force	2N

PLACE INFORMATION	
Dipping mode	No Dipping
Dwell time	0ms
Inspect after dipping	No

## Equipment Platform:

### Samsung SM421 platform

Figure 20 shows the pick and place nozzle designs and the corresponding machine settings which have been successfully used to handle the LUXEON F emitters with the pick and place equipment of Samsung SM421.



Figure 20. Nozzle of Samsung SM421 equipment.

NOZZLE DATA	SAMSUNG ITEM NUMBER
	CN065
Group of Nozzle	General Nozzles
Nozzle Form	Round
Material: Tip	Tungsten Steel
Name	Nozzle Type CN065
Measurements	D=1.2mm d=0.65mm
Spring Constant	0.41N/mm
<b>FOR PRODUCTS</b>	
	LUXEON F
	LUXEON F ES
	LUXEON F Plus
	LUXEON F Premium

PICK INFORMATION	
Pick height	0mm
Mount Height	0mm
Delay - Pick up	30msec
Delay - Place	40msec
Delay - Vac Off	0
Delay - Blow on	0

VISION INFO	
Camera No	Fly Cam 1
Side	4
Outer	7

PLACE INFORMATION	
Speed - XY	1
Speed - Z Pick down	1
Speed - Z Pick Up	1
Speed - R	1
Speed - Z place down	1
Speed - Z place up	1
Z Align speed	1
Soft touch	Not use
Mount Method	Normal

**Equipment Platform:**

**Juki KE-2080L platform**

Figures 21 shows the pick and place nozzle designs and the corresponding machine settings which have been successfully used to handle the LUXEON F emitters with the pick and place equipment of Juki KE-2080L.

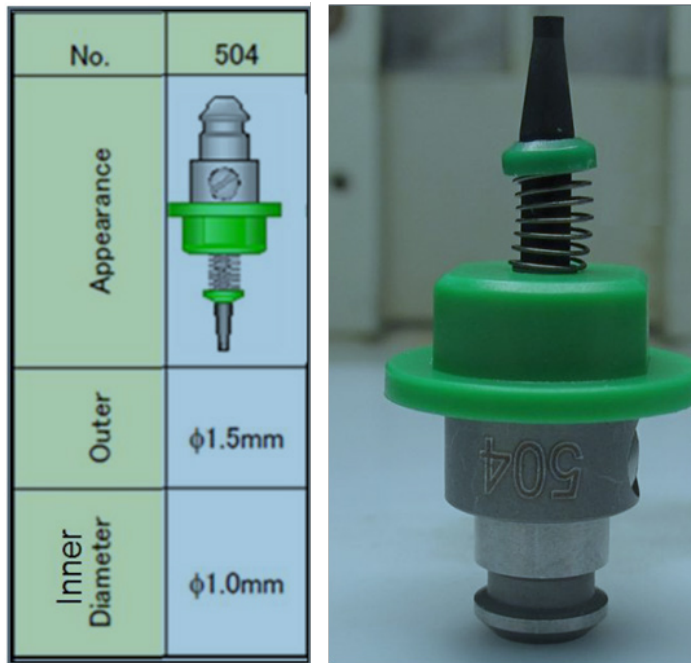

Figure 21. Nozzle of Juki KE-2080L equipment.

NOZZLE DATA	JUKI ITEM NUMBER
	504
Group of Nozzle	General Nozzles
Nozzle Form	Round
Material: Tip	Tungsten Steel
Name	Nozzle Type 504
Measurements	D=1.5mm d=1.0mm
Spring Constant	0.07N/mm
<b>FOR PRODUCTS</b>	
	LUXEON F
	LUXEON F ES
	LUXEON F Plus
	LUXEON F Premium

PICK AND PLACE INFORMATION	
Placing stroke	0mm
Picking stroke	0mm
Placement Force	1.2N
XY speed	Fast 2
Picking Z-down	Fast 2
Picking Z-up	Fast 2
Placing Z-down	Fast 2
Placing Z-up	Fast 2
Laser position	-0.3

VISION INFORMATION	
Centering Method	Laser
Comp shape	Corner Square

## 6.4 Pick and Place Machine Optimization

Unlike other SMD electronic components, the LUXEON F LED has a sensitive top side surface to enhance light extraction. When the cover tape of the reel is removed, there is a possibility for the top side surface to touch a part of the sliding/ guiding metal plate or the shutter of the feeder during indexing. This can lead to scratched or damaged surfaces.

In some pick and place machines a simple modification can be made to the pick and place feeder to achieve optimum yield. One recommendation to reduce damage is to remove the shutter completely and shift the cover tape removal close to the pick-up nozzle. Figure 22 illustrates this recommendation.

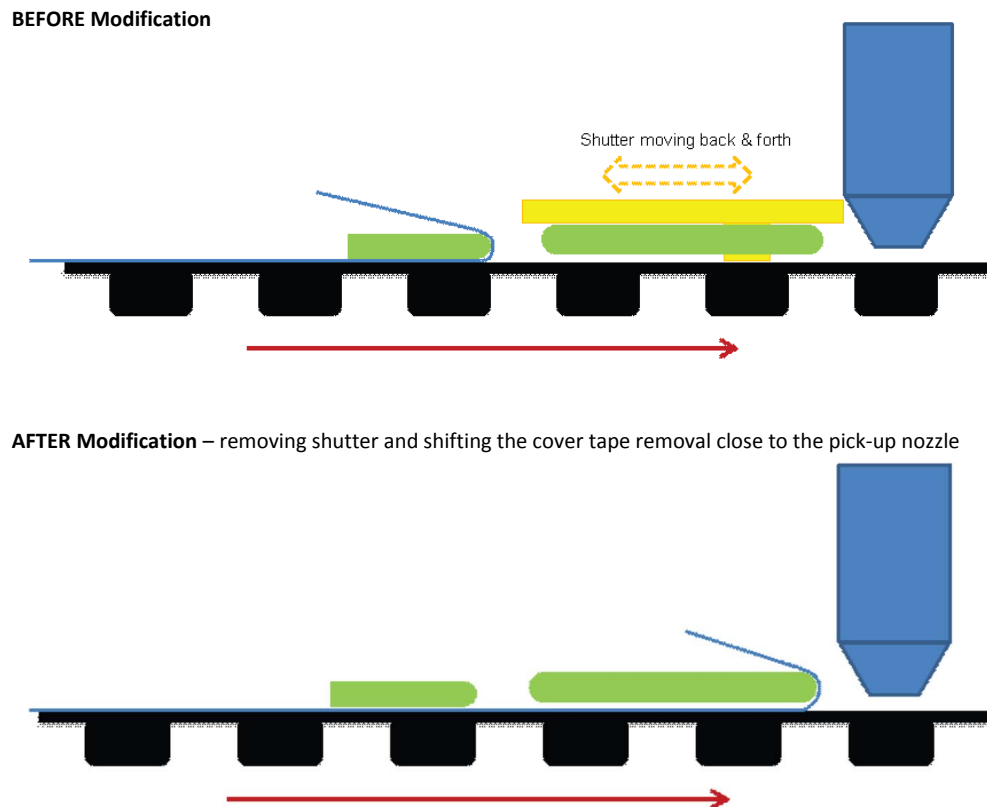

Figure 22. Minor modifications to the pick and place machine minimize the chance of damage to the LUXEON F LED.

In addition to making the above change, Lumileds recommends an electrical (motorized) feeder rather than a mechanical/ pneumatic feeder because units can fall out of the tape pocket or become misaligned due to abrupt movements of the tape.

## 6.5 Placement Accuracy

In order to achieve the highest placement accuracy Lumileds recommends using an automated pick and place tool with a vision system that can recognize the bottom metallization of a LUXEON F.

For high density placement (e.g. spacing between components below 0.5mm) Lumileds recommends using the outline dimensions of the LUXEON F, as mentioned in the datasheet, for recognition. Reducing the tolerance on the outline dimensions to 5% eliminates the risk of staggering components.

## 6.6 Reflow Profile

LUXEON F is compatible with surface mount technology and lead-free reflow. This greatly simplifies the manufacturing process by eliminating the need for adhesives and epoxies. The reflow itself is usually considered as the most important step in reflow soldering. This occurs when the boards move through the oven and the solder paste melts forming the solder joints. To form good solder joints, the time and temperature profile throughout the reflow process must be well maintained.

A temperature profile consists of three primary phases.

1. Preheat: the board enters the reflow oven and is warmed up to a temperature lower than the melting point of the solder alloy.
2. Reflow: the board is heated to a peak temperature above the melting point of the solder, but below the temperature that would damage the components or the board.
3. Cooling down: the board is cooled down rapidly, allowing the solder to freeze, before the board exits the oven.

As a point of reference, the melting temperature for SAC 305 is 217°C, and the minimum peak reflow temperature is 235°C.

Lumileds successfully utilized the reflow profile in Figure 23 and Table 4 for LUXEON F on PCB.

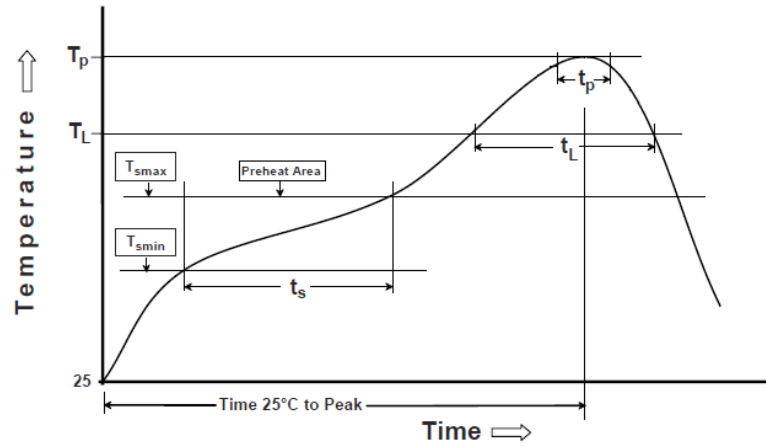

Figure 23. Reflow profile LUXEON F using Hereaus F640 SAC305 solder paste.

Table 4.

PROFILE FEATURE	HERAEUS F640 SAC305
Ramp-Up Rate ( $T_L$ to $T_p$ )	1°C / second avg
Preheat Temperature Min ( $T_{smin}$ )	150°C
Preheat Temperature Max ( $T_{smax}$ )	200°C
Preheat Time ( $T_{smin}$ to $T_{smax}$ )	100–140 seconds
Temperature $T_L$	217°C
Time Maintained Above Temperature $T_L$ ( $t_L$ )	30–90 seconds
Peak / Classification Temperature ( $T_p$ )	235–260°C
Time Within 5°C of Actual Peak Temperature ( $t_p$ )	20–30 seconds
Max Ramp-Down Rate ( $T_p$ to $T_L$ )	2°C / second
Time 25°C to Peak Temperature	240–310 seconds

**Notes for Table 4:**

All temperatures refer to the application Printed Circuit Board (PCB), measured on the surface adjacent to the package body.

## 6.7 Reflow Accuracy

Lumileds has measured the typical post reflow accuracies as mentioned in Figure 24 by characterizing the distance between local alignment fiducials and the optical center of the applicable LED. It needs to be noted that, due to the manufacturing processes of the PCB, the drilled holes are less accurately positioned as the solder resist defined copper areas.

The solder pads design and the solder paste stencil design were according to the recommended LUXEON F layout (see Figure 7 and 17).

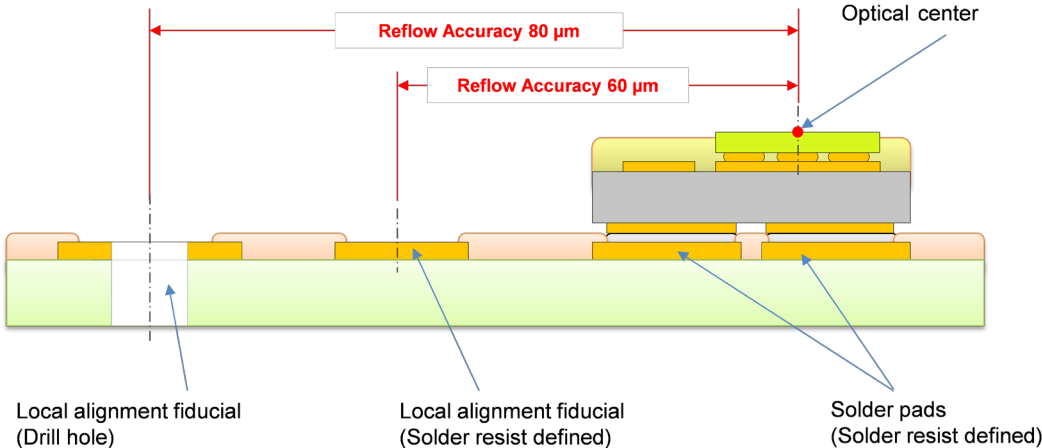

Note: Drilled holes are, due to an additional overlay error in the manufacturing process, less accurately positioned towards the solder pads as solder resist defined fiducials.

Figure 24. Local alignment fiducials for reflow accuracy.

## 6.8 Void Inspection

A large percentage of voids in the thermal path will increase the thermal resistance. Figure 25 shows the impact of solder voiding on the Junction to Heat sink resistance based on simulated data. The board parameters are similar to Figure 14 (FR4 with filled and capped vias).

An inline X-ray machine can be used to inspect on voids after reflowing.

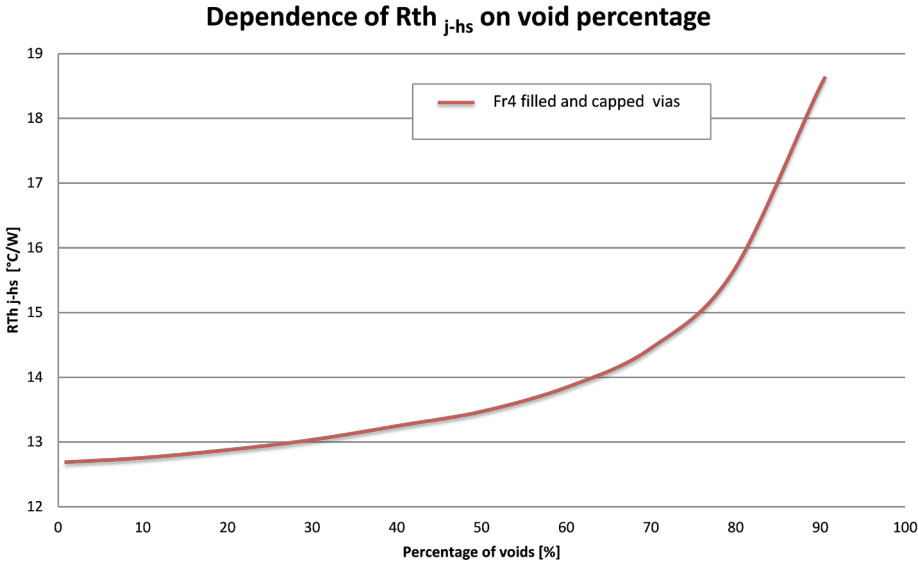

Figure 25. Impact of voids in the solder joint on thermal resistance for filled and capped via design.



## 6.9 FR4 Board Handling

As with all electronic circuits, boards should only be handled by the edges. Components should not be touched unless absolutely required. The substrate of a LUXEON F is made of ceramic, a relatively brittle material. Even though this product has a small form factor and is unlikely to cause any problems, forces on the package should be kept to a minimum. In particular, excessive bending forces on the package may crack the ceramic substrate or break the solder joints.

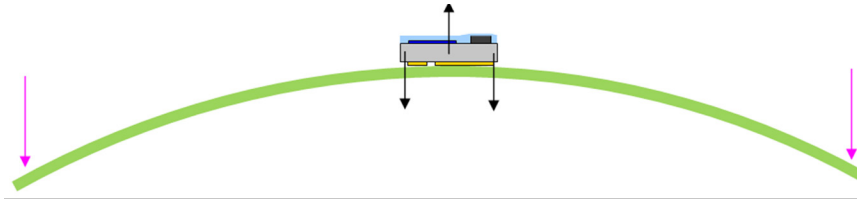

Figure 26. Forces acting onto package when board is bent.

Figure 26 shows what forces may, inadvertently, be applied to a LUXEON F when a flat assembled board is bent. This can happen, for example, when “punching-off” or “breaking-off” LED strips of a PCB panel (Figure 27).

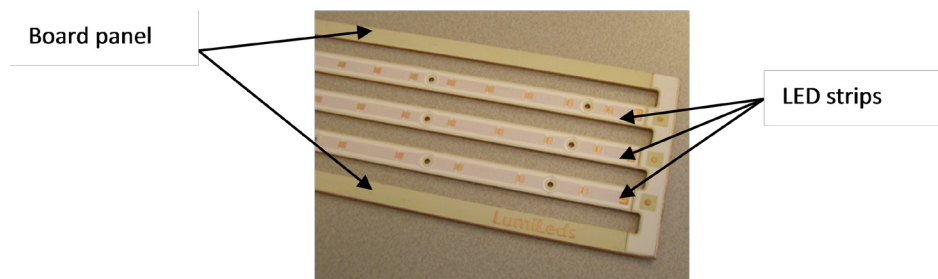

Figure 27. PCB panel consisting of several strips of LEDs.

A printed circuit board may warp after reflow when layers with different CTE (coefficient of thermal expansion) are applied to the top and bottom of the boards. If the PCB is subsequently secured to a flat surface, a vertical force is applied to the ceramic package (see Figure 28). If this force is large enough, the ceramic substrate package may break. To minimize the chance of cracking the ceramic package, orientate the package such that the long side of the package is perpendicular to the dominant warpage direction.

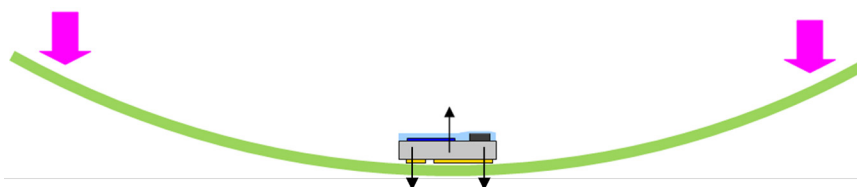

Figure 28. Securing a warped board to flat surface may cause excessive stress on the ceramic substrate.

Board warpage can be minimized by understanding how different CTE materials are stacked up. For example, when an FR4 board is sandwiched between two full copper sheets, adding thin isolation lines in the copper sheet to create copper islands can minimize board warpage as shown in Figure 29.

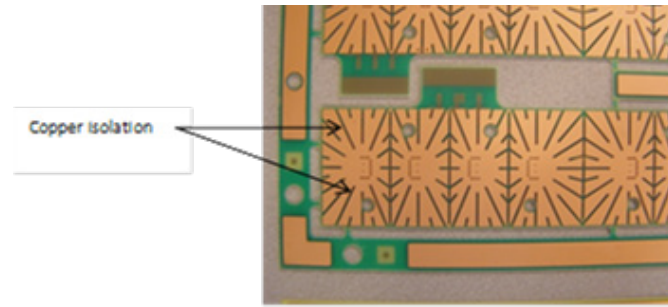

Figure 29. Reducing board warpage by creating copper islands.

## 6.10 Flexible Circuit Board Handling

The LUXEON F has no protective coating to protect against impacts.

Forces on the package should be kept to a minimum. In particular, excessive bending forces on the package may crack the ceramic substrate or break the solder joints.

Circuit boards should be handled, such that all ends are controlled. Allowing a free end to go uncontrolled increases the chance that any LED on that section can inadvertently contact another surface at a force greater than those allowed.

Complex systems, with multiple rigid sections, connected by flexible areas, may require fixturing to prevent LED surfaces from contacting lamp housings during assembly.

Any LED that has inadvertently contacted a surface should be tested per Lumileds' guidelines.

## 7. JEDEC Moisture Sensitivity Level

The LUXEON F has a JEDEC moisture sensitivity level of 1. This is the highest level offered in the industry and highest level within the JEDEC standard.

This provides the customer with ease of assembly. The customer no longer needs to be concerned about bake out times and floor life. No bake out time is required for a moisture sensitivity level of 1.

JEDEC has defined eight levels for moisture sensitivity, as shown in Table 5.

Table 5. JEDEC Moisture Sensitivity Levels

LEVEL	FLOOR LIFE		SOAK REQUIREMENTS			
			STANDARD		ACCELERATED EQUIVALENT	
	TIME	CONDITIONS	TIME (HOURS)	CONDITIONS	TIME (HOURS)	CONDITIONS
1	Unlimited	≤30°C / 85% RH	168 +5/-0	85°C / 85% RH		
2	1 year	≤30°C / 60% RH	168 +5/-0	85°C / 60% RH		
2a	4 weeks	≤30°C / 60% RH	696 +5/-0	30°C / 60% RH	120 +1/-0	60°C / 60% RH
3	168 hours	≤30°C / 60% RH	192 +5/-0	30°C / 60% RH	40 +1/-0	60°C / 60% RH
4	72 hours	≤30°C / 60% RH	96 +2/-0	30°C / 60% RH	20 +0.5/-0	60°C / 60% RH
5	48 hours	≤30°C / 60% RH	72 +2/-0	30°C / 60% RH	15 +0.5/-0	60°C / 60% RH
5a	24 hours	≤30°C / 60% RH	48 +2/-0	30°C / 60% RH	10 +0.5/-0	60°C / 60% RH
6	Time on Label (TOL)	≤30°C / 60% RH	TOL	30°C / 60% RH		

## 8. Product Packaging Consideration—Chemical Compatibility

The LUXEON F package contains a silicone overcoat to protect the LED chip and extract the maximum amount of light. As with most silicones used in LED optics, care must be taken to prevent any incompatible chemicals from directly or indirectly reacting with the silicone.

The silicone overcoat in LUXEON F is gas permeable. Consequently, oxygen and volatile organic compound (VOC) gas molecules can diffuse into the silicone overcoat. VOCs may originate from adhesives, solder fluxes, conformal coating materials, potting materials and even some of the inks that are used to print the PCBs.

Some VOCs and chemicals react with silicone and produce discoloration and surface damage. Other VOCs do not chemically react with the silicone material directly but diffuse into the silicone and oxidize during the presence of heat or light. Regardless of the physical mechanism, both cases may affect the total LED light output. Since silicone permeability increases with temperature, more VOCs may diffuse into and/or evaporate out from the silicone.

Careful consideration must be given to whether LUXEON F emitters are enclosed in an “air tight” environment or not. In an “air tight” environment, some VOCs that were introduced during assembly may permeate and remain in the silicone overcoat. Under heat and “blue” light, the VOCs inside the silicone overcoat may partially oxidize and create a silicone discoloration, particularly on the surface of the LED where the flux energy is the highest. In an air rich or “open” air environment, VOCs have a chance to leave the area (driven by the normal air flow). Transferring the devices which were discolored in the enclosed environment back to “open” air may allow the oxidized VOCs to diffuse out of the silicone overcoat and may restore the original optical properties of the LED.

Determining suitable threshold limits for the presence of VOCs is very difficult since these limits depend on the type of enclosure used to house the LEDs and the operating temperatures. Also, some VOCs can photo-degrade over time.

Table 6 provides a list of commonly used chemicals that should be avoided as they may react with the silicone material. Note that Lumileds does not warrant that this list is exhaustive since it is impossible to determine all chemicals that may affect LED performance.

The chemicals in Table 6 are typically not directly used in the final products that are built around LUXEON F emitters. However, some of these chemicals may be used in intermediate manufacturing steps (e.g. cleaning agents). Consequently, trace amounts of these chemicals may remain on (sub) components, such as heat sinks. Lumileds, therefore, recommends the following precautions when designing your application:

- When designing secondary lenses to be used over an LED, provide a sufficiently large air-pocket and allow for “ventilation” of this air away from the immediate vicinity of the LED
- Use mechanical means of attaching lenses and circuit boards as much as possible. When using adhesives, potting compounds and coatings, carefully analyze its material composition and do thorough testing of the entire fixture under High Temperature over Life (HTOL) conditions.

Table 6. List of Commonly Used Chemicals That May Damage the Silicone Overcoat of LUXEON F.

CHEMICAL NAME	NORMALLY USED AS
Hydrochloric Acid	Acid
Sulfuric Acid	Acid
Nitric Acid	Acid
Acetic Acid	Acid
Sodium Hydroxide	Alkali
Potassium Hydroxide	Alkali
Ammonia	Alkali
MEK (Methyl Ethyl Ketone)	Solvent
MIBK (Methyl Isobutyl Ketone)	Solvent
Toluene	Solvent
Xylene	Solvent
Benzene	Solvent
Gasoline	Solvent
Mineral Spirits	Solvent
Dichloromethane	Solvent
Tetracholorometane	Solvent
Castor Oil	Oil
Lard	Oil
Linseed Oil	Oil
Petroleum	Oil
Silicone Oil	Oil
Halogenated Hydrocarbons (containing F, Cl, Br elements)	Misc
Rosin Flux	Solder Flux
Acrylic Tape	Adhesive



## About Lumileds

Lumileds is the global leader in light engine technology. The company develops, manufactures and distributes groundbreaking LEDs and automotive lighting products that shatter the status quo and help customers gain and maintain a competitive edge.

With a rich history of industry “firsts,” Lumileds is uniquely positioned to deliver lighting advancements well into the future by maintaining an unwavering focus on quality, innovation and reliability.

To learn more about our portfolio of light engines, visit [lumileds.com](http://lumileds.com).



---

©2016 Lumileds Holding B.V. All rights reserved.  
LUXEON is a registered trademark of the Lumileds Holding B.V.  
in the United States and other countries.

[lumileds.com](http://lumileds.com)

Neither Lumileds Holding B.V. nor its affiliates shall be liable for any kind of loss of data or any other damages, direct, indirect or consequential, resulting from the use of the provided information and data. Although Lumileds Holding B.V. and/or its affiliates have attempted to provide the most accurate information and data, the materials and services information and data are provided “as is,” and neither Lumileds Holding B.V. nor its affiliates warrants or guarantees the contents and correctness of the provided information and data. Lumileds Holding B.V. and its affiliates reserve the right to make changes without notice. You as user agree to this disclaimer and user agreement with the download or use of the provided materials, information and data.